



**SIRIUS
3RM1**



ET 200SP



ET 200pro



SIRIUS M200D

contents

SIRIUS 3RM1 motor starters

General data	6/2 – 6/7
Selection and ordering	6/8 – 6/9
Accessories	6/10 – 6/11

ET 200SP motor starters

General data	6/12 – 6/18
Selection and ordering	6/19
Base units and control module	6/20
Accessories	6/21

ET 200pro motor starters

General data	6/22 – 6/27
Standard motor starters	6/28
High Feature motor starters	6/29
ET 200pro isolator modules	6/30
ET 200pro safety motor starters	6/31

Solutions local/PROFIsafe

- Safety modules local	6/32 – 6/33
- Safety modules PROFIsafe	6/34
Accessories for ET 200pro motor starters	6/35 – 6/39

Software

Motor Starter ES	6/40
------------------	------

SIRIUS M200D motor starters

General data	6/41 – 6/43
--------------	-------------

M200D motor starters for AS-Interface

General data	6/44 – 6/46
M200D Basic motor starters	6/47
M200D Standard motor starters	6/48

M200D motor starters for PROFIBUS/PROFINET

General data	6/49 – 6/54
Communication modules, motor starter modules	6/55

Software

Motor Starter ES	6/56
------------------	------

Accessories

For all M200D motor starters	6/57 – 6/61
For M200D motor starters for AS-Interface	6/62 – 6/63
For M200D motor starters for PROFIBUS	6/64
For M200D motor starters for PROFINET	6/65

Hybrid fieldbus connections

General data	6/66
Selection and ordering	6/67

SIRIUS 3RM1 motor starters

Introduction

Overview



3RM13 motor starter with reversing functionality, electronic overload protection and safety-related shutdown

Seamlessly integrated safety right through to the main circuit

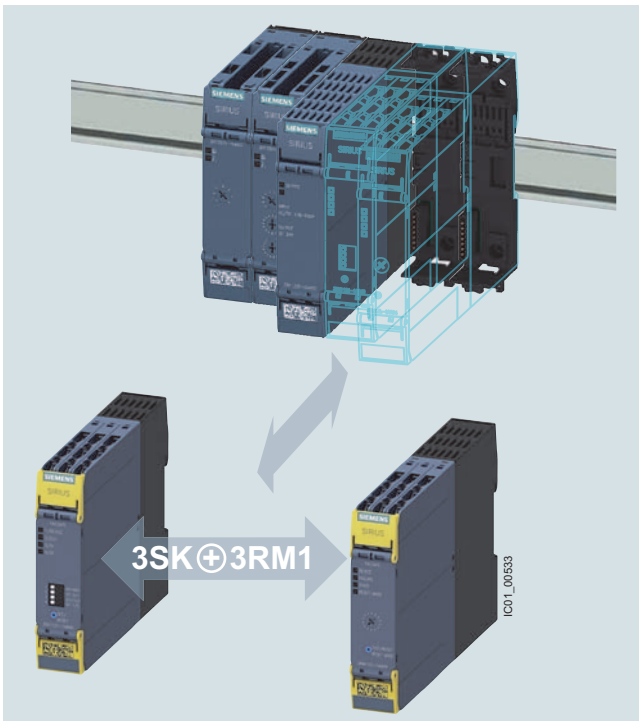

Problem-free integration of functional safety into the main circuit through the simple combination of 3RM1 and 3SK devices

SIRIUS 3RM1 motor starters are compact devices, 22.5 mm wide, combining a large number of functions in a single enclosure. They consist of combinations of relay contacts, power semiconductors (hybrid technology), and an electronic overload relay for operational switching of three-phase motors up to 3 HP (at 480V).

The 3RM1 motor starters with overload protection with wide setting range are available as direct-on-line starters and reversing starters and as versions with safety-related shutdown up to SIL 3/PL e.

Functional safety in the main circuit needs to be both simple and flexible.

The unique compatibility of hybrid 3RM1 fail-safe motor starters and 3SK safety relays means that integrated functional safety right through to the main circuit is no longer a problem.

Their compact design allows the motor starters to be installed to the right of the safety relay in a simple manner, just like an output expansion. The wiring of the safety-related signals to the relay can be performed simply, quickly and in an error-free manner using the device connector.

The ergonomically designed enclosure with removable terminals and terminal labeling in the hinged cover allows for the cables to be conveniently diagonally mounted from the front. Either screw or spring-loaded terminals with push-in technology are available.

Highlights

- Fail-safe disconnection of motors up to 3 kW
- Problem-free combination of fail-safe motor starters and safety relays
- End-to-end system, simple setup using device connectors
- Ergonomic enclosure

Note:

For SIRIUS 3SK safety relays, [see page 13/133](#).

SIRIUS 3RM1 motor starters

General data

Article No. scheme

Product versions		Article number								
Product function	Direct-on-line starters	3RM10	0	□	–	□	AA	□	4	
	Failsafe direct-on-line starters	3RM11	0	□	–	□	AA	□	4	with ATEX certification and safety-related shutdown
	Reversing starters	3RM12	0	□	–	□	AA	□	4	
	Failsafe reversing starters	3RM13	0	□	–	□	AA	□	4	with ATEX certification and safety-related shutdown
Wide setting range for electronic overload release	0.1 ... 0.5 A		1							
	0.4 ... 2.0 A		2							For motor standard output up to 3/4 HP ¹⁾
	1.6 ... 7.0 A (UL=6.1A)		7							For motor standard output up to 3 HP ¹⁾
Connection method	Screw terminals								1	
	Spring-loaded terminals (push-in)								2	
	Mixed connection method								3	Spring-loaded terminals (push-in)
Rated control supply voltage U_s	24 V DC									0
	110 ... 230 V AC; 110 V DC									1
Example		3RM13	0	1	–	2	AA	0	4	

¹⁾ Standard three-phase motor; the actual startup characteristics of the motor as well as its rated data are important factors here.

Note:

The article number scheme shows an overview of product versions for better understanding of the logic behind the article numbers.

For your orders, please use the article numbers quoted in the selection and ordering data.

Benefits

Product advantages

- Less space required in the control cabinet (20 to 80%) thanks to high functional density, which also means reduced wiring and testing
- Greater endurance and reduced heat losses thanks to hybrid technology
- Lower costs for stock keeping and configuration as a result of the wide setting range of the electronic overload release (up to 1:5)
- Fast wiring without tools for rigid conductors or conductors equipped with end sleeves thanks to spring-loaded terminals (push-in)
- Safety-related shutdown in accordance with SIL 3/PL e by shutting down the control supply voltage without additional devices in the main circuit
- The motor starters can be ideally combined with 3SK safety relays for safety-related shutdown (see page 13/133).
- Motor status feedback to the higher-level control system in the case of 3RM10 and 3RM12 motor starters in the 24 V DC version
- Virtually error-free wiring on the mains connection side and reduction in short-circuit protective devices by means of 3RM19 infeed system
- ATEX certification of the overload protection of the 3RM1 Failsafe motor starters: "Increased safety" type of protection EEx e according to ATEX directive 2014/34/EU
- The 3RM1 motor starters can be used with highly energy-efficient IE3/IE4 motors. In this regard, please observe the information on dimensioning and configuring, see [Application Manual](#).
For more information about IE3/IE4, see page 1/7.

Standards and approvals

- IEC/EN 60947-4-2
- UL 60947-4-2
- CSA
- ATEX
- IEC 61508-1: SIL 3
- ISO 13849: PL e
- CCC approval for China

SIRIUS 3RM1 motor starters

General data

Technical specifications

More information

Industry Mall, see www.siemens.com/product?3RM1

Equipment Manual, see

<https://support.industry.siemens.com/cs/ww/en/view/66295730>FAQs, see <https://support.industry.siemens.com/cs/ww/en/ps/16311/faq>

Article number

**3RM10,
3RM12****3RM11,
3RM13**

General technical specifications:

Dimensions (W x H x D)

mm 22.5 x 100 x 141.6

Ambient temperature

• During operation

°C -25 ... +60

• During storage

°C -40 ... +70

• During transport

°C -40 ... +70

Installation altitude at height above sea level, maximum

m 4 000 2 000

Shock resistance

6 g / 11 ms

Vibration resistance

1 ... 6 Hz, 15 mm; 20 m/s², 500 Hz

Degree of protection

IP20

Mounting position

Vertical, horizontal, standing (consider derating)

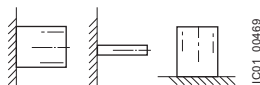

Article number

3RM1.01**3RM1.02****3RM1.07**

Main circuit:

Operational voltage, rated value, maximum

V 500

Operating frequency

Hz 50/60

Operational current at AC-53a at 400 V at an ambient temperature of 40 °C

A 0.5 2 7

Minimum load [% of IM]

% 20

Adjustable current response value of the inverse-time delayed overload release

A 0.1 ... 0.5 0.4 ... 2 1.6 ... 7

Article number

3RM1.0.-AA04**3RM1.0.-AA14**

Control circuit:

Type of voltage of the control supply voltage

DC AC/DC

Control supply voltage

• At DC

V 24

110

• At AC at 50 Hz

V --





110 ... 230

Frequency of the control supply voltage

Hz -- 50/60

SIRIUS 3RM1 motor starters

General data

Type	3RM1.0.-1AA.4	3RM1.0.-3AA.4	3RM1.0.-2AA.4
Connections/terminals:			
Type of electrical connection for main circuit (1 or 2 conductors can be connected)	 Screw terminals		 Spring-loaded terminals (push-in)
Connectable conductor cross-section for main contacts			
• Solid	mm ²	1 x (0.5 ... 4), 2 x (0.5 ... 2.5)	1 x (0.5 ... 4)
• Finely stranded	mm ²	1 x (0.5 ... 4), 2 x (0.5 ... 1.5)	1 x (0.5 ... 2.5)
- With end sleeve			1 x (0.5 ... 4)
- Without end sleeve	mm ²	--	
Type of electrical connection for auxiliary and control circuit (1 or 2 conductors can be connected)	 Screw terminals		 Spring-loaded terminals (push-in)
Type of connectable conductor cross-sections for auxiliary contacts			
• Solid	mm ²	1 x (0.5 ... 2.5), 2 x (1.0 ... 1.5)	1 x (0.5 ... 1.5), 2 x (0.5 ... 1.5)
• Finely stranded	mm ²	1 x (0.5 ... 2.5), 2 x (0.5 ... 1)	1 x (0.5 ... 1.0), 2 x (0.5 ... 1.0)
- With end sleeve			
- Without end sleeve	mm ²	--	1 x (0.5 ... 1.5), 2 x (0.5 ... 1.5)
Type of connectable conductor cross-sections for AWG cables			
• For main contacts		1 x (20 ... 12), 2 x (20 ... 14)	1 x (20 ... 12)
• For auxiliary contacts		1 x (20 ... 14), 2 x (18 ... 16)	1 x (20 ... 16), 2 x (20 ... 16)

Accessories

More information

Equipment Manual, see <https://support.industry.siemens.com/cs/ww/en/view/66295730>

Three-phase infeed system (3RM19 three-phase busbar system)

The system permits an easy, time-saving and safe means of feeding two or more 3RM1 motor starters. It can be used only with motor starters with screw terminals and in combination with 8US1716-ORK00 adapters for mounting rails in the main circuit.

The maximum summation current must not exceed 25 A. The primary infeed is connected via a three-phase infeed terminal.

The busbars are available in three lengths, for two, three or five motor starters. More than five devices can be connected by clamping the connection tags of a second busbar rotated by 180°.

The three-phase busbars are finger-safe but empty connection tags must be fitted with covers.

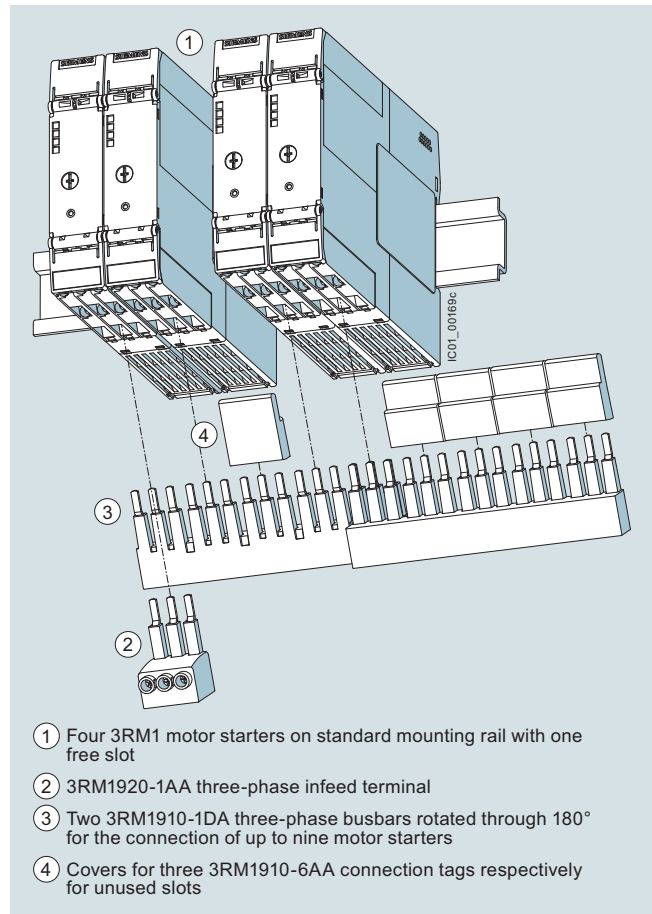

3RM19 infeed system with three-phase infeed terminal: In the above example, two three-phase busbars (5-pole busbars) rotated through 180° allow up to nine 3RM1 motor starters to be connected. Contact with the unused connection tags in unoccupied positions is prevented safely by the covers.

SIRIUS 3RM1 motor starters

General data

Fuse module for the use of 3RM1 motor starters on 8US busbar systems and mounting rails

The fuse module permits the very compact construction of a load feeder with a maximum width of 22.5 mm. The 3RM1 motor starter in combination with the integrated fuses for short-circuit protection can therefore be used on 8US busbar systems. Thanks to the range of different adapters, the fuse module can be used in all 60 mm busbar systems and also in compact busbar systems and on mounting rails. The interface to the adapter also permits a simple and secure replacement of the load feeder.

The fuse module can be combined with all 3RM1 motor starters. The easily replaceable fuses protect the connected motor and the cables.

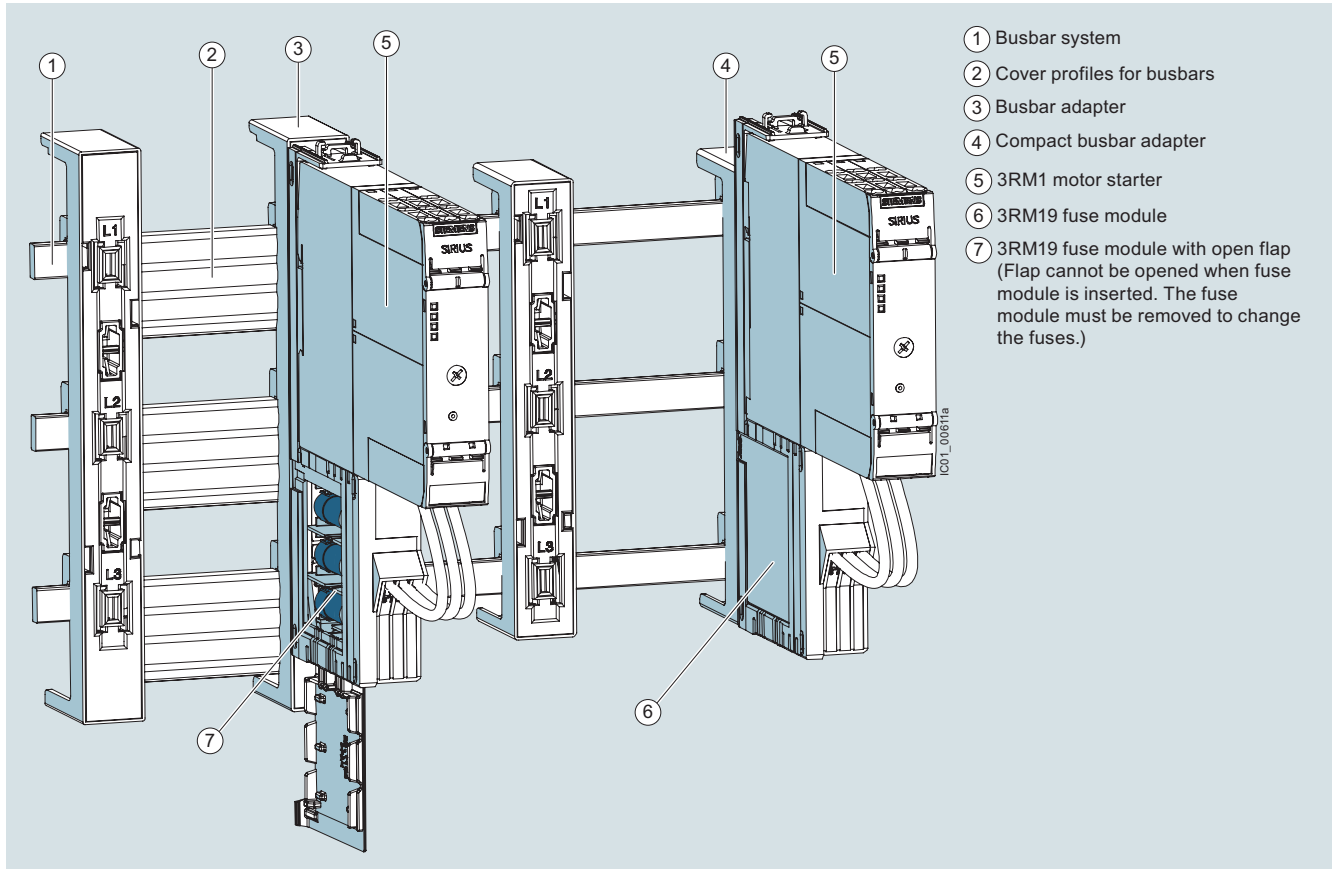

By means of the fuse module, 3RM1 motor starters can be used in busbar systems and 8US compact busbar systems, as well as on mounting rails

SIRIUS 3RM1 motor starters

General data

Device connectors for the control circuit

The device connectors for 3RM1 motor starters (24 V DC control supply voltage only) reduce the outlay for cabling by looping through the control supply voltage. The device connectors can be snapped onto a standard mounting rail or fixed to a level mounting panel using screws.

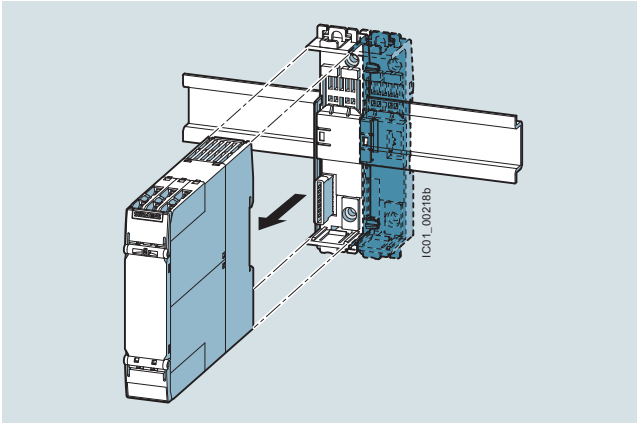

Device connector with 3RM1 motor starter

Using the device connectors exclusively for feeding in the control supply voltage

By using device connectors, a maximum of five motor starters can be supplied with 24 V DC control supply voltage. This requires the control supply voltage to be applied to the A1 and A2 terminals of only one motor starter.

Device daisy chain connectors can be used for gaps between two motor starters. Device termination connectors terminate a group.

Using the device connectors for safe group shutdown

In combination with the 3RM11 and 3RM13 fail-safe motor starters, the device connector can also be used for safety-related shutdown. For this application, groups of no more than five fail-safe motor starters can be connected using a device connector, and the group must be terminated with a termination connector. Removing the control voltage supply from the first motor starter will safely shut down the whole group.

Safe group shutdown can be implemented particularly easily in conjunction with 3SK safety relays. In this case, up to five motor starters can be directly connected to 3SK safety relays via the device connector and then safely shut down (see page 13/133).

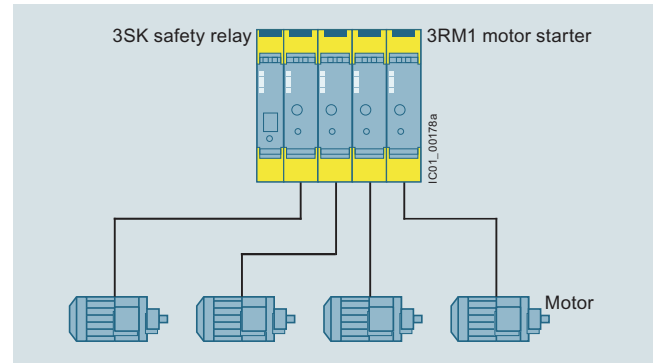

Ideal connection: Combination of four SIRIUS 3RM1 Failsafe motor starters with SIRIUS 3SK safety relays

Electromechanical switching devices in series with hybrid motor starters

Switching an inductive load - in particular of motors < 1 kW with high inductance - with an electromechanical switching device (e.g. contactor) can cause high and steep voltage edges.

The resulting faults/damage can be prevented by first disconnecting with the hybrid motor starter or by using EMC suppression modules:

- For 3RT2916-1P.. EMC suppression modules for direct mounting on the contactor, see page 2/78
- For motor suppression modules that are fitted in the main circuit, (see page 6/11).

Note:

For more information, see <https://support.industry.siemens.com/cs/ww/en/view/109758696>.





SIRIUS 3RM1 motor starters

Selection and ordering data **IE3/IE4 ready**

Selection and ordering data

More information

Industry Mall, see www.siemens.com/product?3RM1

	Operational power for three-phase motor at 460 V ¹⁾	Adjustable current response value of the inverse-time delayed overload release	Control supply voltage		SD	Article No.	Price per PU	PU (UNIT, SET, M)	PS*
			At DC	At AC at 50 Hz					
	HP	A	V	V	d				
Direct-on-line starters									
	--	0.1 ... 0.5	24	--	2	3RM1001-□AA04		1	1 unit
	3/4	0.4 ... 2	24	--	2	3RM1002-□AA04		1	1 unit
	3	1.6 ... 6.1	24	--	2	3RM1007-□AA04		1	1 unit
	--	0.1 ... 0.5	110	110 ... 230	2	3RM1001-□AA14		1	1 unit
	3/4	0.4 ... 2	110	110 ... 230	2	3RM1002-□AA14		1	1 unit
	3	1.6 ... 6.1	110	110 ... 230	2	3RM1007-□AA14		1	1 unit
Reversing starters									
	--	0.1 ... 0.5	24	--	2	3RM1201-□AA04		1	1 unit
	3/4	0.4 ... 2	24	--	2	3RM1202-□AA04		1	1 unit
	3	1.6 ... 6.1	24	--	2	3RM1207-□AA04		1	1 unit
	--	0.1 ... 0.5	110	110 ... 230	2	3RM1201-□AA14		1	1 unit
	3/4	0.4 ... 2	110	110 ... 230	2	3RM1202-□AA14		1	1 unit
	3	1.6 ... 6.1	110	110 ... 230	2	3RM1207-□AA14		1	1 unit
Failsafe direct-on-line starters									
	--	0.1 ... 0.5	24	--	2	3RM1101-□AA04		1	1 unit
	3/4	0.4 ... 2	24	--	2	3RM1102-□AA04		1	1 unit
	3	1.6 ... 6.1	24	--	2	3RM1107-□AA04		1	1 unit
	--	0.1 ... 0.5	110	110 ... 230	2	3RM1101-□AA14		1	1 unit
	3/4	0.4 ... 2	110	110 ... 230	2	3RM1102-□AA14		1	1 unit
	3	1.6 ... 6.1	110	110 ... 230	2	3RM1107-□AA14		1	1 unit
Failsafe reversing starters									
	--	0.1 ... 0.5	24	--	2	3RM1301-□AA04		1	1 unit
	3/4	0.4 ... 2	24	--	2	3RM1302-□AA04		1	1 unit
	3	1.6 ... 6.1	24	--	2	3RM1307-□AA04		1	1 unit
	--	0.1 ... 0.5	110	110 ... 230	2	3RM1301-□AA14		1	1 unit
	3/4	0.4 ... 2	110	110 ... 230	2	3RM1302-□AA14		1	1 unit
	3	1.6 ... 6.1	110	110 ... 230	2	3RM1307-□AA14		1	1 unit

Type of electrical connection







- Screw terminals for main circuit, screw terminals for control circuit
- Spring-loaded terminals (push-in) for main circuit, spring-loaded terminals (push-in) for control circuit
- Screw terminals for main circuit, spring-loaded terminals (push-in) for control circuit

¹⁾ The actual startup characteristics of the motor as well as its rated data are important factors here.

1
2
3

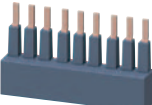
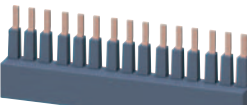
SIRIUS 3RM1 motor starters







Accessories

Product designation	SD	Article No.	Price per PU	PU (UNIT, SET, M)	PS*
Three-phase infeed system for 3RM1 with screw terminals					
 <p>3RM1920-1AA</p>		Three-phase infeed terminals • For three-phase busbars		1	1 unit
 <p>3RM1910-1AA</p>		Three-phase busbars • For 2 motor starters		1	1 unit
 <p>3RM1910-1BA</p>		• For 3 motor starters		1	1 unit
 <p>3RM1910-1DA</p>		• For 5 motor starters		1	1 unit
 <p>3RM1910-6AA</p>		Covers For 3 connection tags of the three-phase busbars		1	10 units
Fuse modules for 3RM1 for use on busbars or mounting rails					
 <p>3RM1932-1AB</p>		Fuse module with 3NW6007-1 fuse	2	1	1 unit
		Fuse module without fuse¹⁾	10	1	1 unit
Adapters					
 <p>8US1216-0AS00</p>		Adapters for 60 mm busbar systems 22.5 mm x 200 mm x 41.5 mm <u>Note:</u> The adapter can be used on busbars with a width of 12 mm and a thickness of 5 mm or 10 mm.	5	1	1 unit
 <p>8US1616-0AK02</p>		Adapters for 60 mm compact busbar systems 22.5 mm x 160 mm x 41.5 mm <u>Note:</u> The adapter can be used on busbars with a width of 12 mm, 15 mm, 20 mm, 25 mm or 30 mm and a thickness of 5 mm or 10 mm.	5	1	1 unit

¹⁾ For details of alternative fuses, see [Equipment Manual](#).

SIRIUS 3RM1 motor starters

Accessories





Product designation	SD	Article No.	Price per PU	PU (UNIT, SET, M)	PS*
Adapters					
 8US1716-0RK00	5	8US1716-0RK00		1	1 unit
Adapter for 35 mm DIN mounting rails 22.5 mm x 185 mm x 23.5 mm					
Cover profiles¹⁾²⁾					
Cover profiles for busbars					
 8US1922-2CA00	2	8US1922-2CA00		1	10 units
12 mm x 5 mm x 1 000 mm 40 mm or 60 mm center-to-center busbar clearance depending on busbar system					
 8US1922-2AA00	2	8US1922-2AA00		1	10 units
15 mm x 5 mm x 1 000 mm 20 mm x 5 mm x 1 000 mm 25 mm x 5 mm x 1 000 mm 30 mm x 5 mm x 1 000 mm 40 mm or 60 mm center-to-center busbar clearance depending on busbar system					
 8US1922-2BA00	2	8US1922-2BA00		1	10 units
12 mm x 10 mm x 1 000 mm 15 mm x 10 mm x 1 000 mm 20 mm x 10 mm x 1 000 mm 25 mm x 10 mm x 1 000 mm 30 mm x 10 mm x 1 000 mm 60 mm center-to-center busbar clearance					
Device connectors					
 3ZY1212-2EA00	2	3ZY1212-2EA00		1	1 unit
Device connectors For 3RM1 motor starters, 24 V DC, 22.5 mm					
 3ZY1212-2AB00	2	3ZY1212-2AB00		1	1 unit
Device daisy chain connectors For 3RM1 motor starters 24 V DC, 22.5 mm For gaps without motor starters in assemblies					
 3ZY1212-2FA00	2	3ZY1212-2FA00		1	1 unit
Device termination connectors For 3RM1 motor starters, 24 V DC, 22.5 mm					

¹⁾ The cover profiles for busbars can be used for maintaining minimum spacing between the load feeders.

²⁾ For further accessories for the configuration of a busbar system, see [Catalog LV 10](#).

SIRIUS 3RM1 motor starters

Accessories

	Product designation	SD	Article No.	Price per PU	PU (UNIT, SET, M)	PS*	
Removable terminals							
 <p>3ZY1122-1BA00</p>	Terminal for main circuit, 2-pole <ul style="list-style-type: none"> Screw terminals, 1 x 4 mm² 	2	Screw terminals  3ZY1122-1BA00		1	6 units	
		2	Spring-loaded terminals (push-in)  3ZY1122-2BA00		1	6 units	
	 <p>3ZY1131-1BA00</p>	Terminal for control circuit, 3-pole <ul style="list-style-type: none"> Screw terminals, 1 x 2.5 mm² Spring-loaded terminals (push-in), 1 x 2.5 mm² 	2	Screw terminals  3ZY1131-1BA00		1	6 units
			2	Spring-loaded terminals (push-in)  3ZY1131-2BA00		1	6 units
Further accessories							
 <p>3ZY1311-0AA00</p>	Push-in lugs for wall mounting 2 lugs per device are required	2	3ZY1311-0AA00		1	10 units	
 <p>3ZY1321-2AA00</p>	Sealable covers, 22.5 mm For simple protection against unauthorized access	2	3ZY1321-2AA00		1	5 units	
 <p>3ZY1440-1AA00</p>	Coding pins for removable terminals For mechanical coding of the terminals	2	3ZY1440-1AA00		1	12 units	
 <p>3ZY1450-1AB00</p>	Hinged cover Replacement cover, without terminal labeling, 22.5 mm wide <ul style="list-style-type: none"> Titanium gray Yellow 	2	3ZY1450-1AB00		1	5 units	
		2	3ZY1450-1BB00		1	5 units	
 <p>3RK1911-6EA00</p>	Motor suppression module <ul style="list-style-type: none"> Square Round 	15	3RK1911-6EA00		1	1 unit	
		15	3RK1911-6EB00		1	1 unit	
 <p>3RA2908-1A</p>	Screwdrivers For all SIRIUS devices with spring-loaded terminals Length approx. 200 mm, 3.0 mm x 0.5 mm, titanium gray/black, partially insulated	2	Spring-loaded terminals  3RA2908-1A		1	1 unit	

ET 200SP motor starter

Introduction

Overview

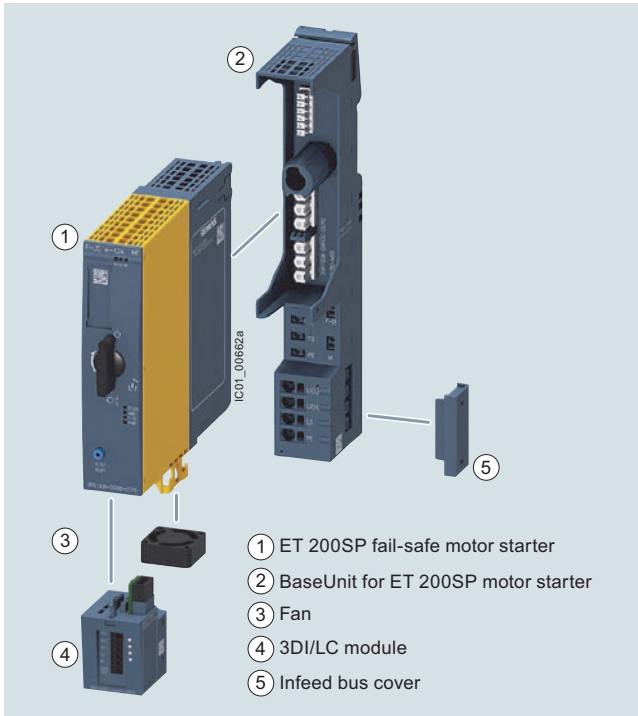

Motor starter, BaseUnit, fan and 3DI/LC control module

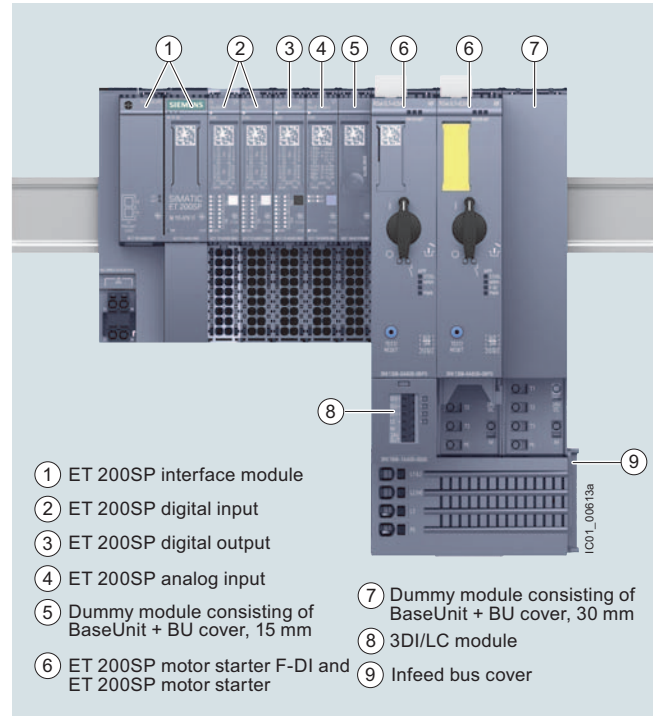

3RK1308 motor starter in the ET 200SP I/O system

More information

Homepage, see www.siemens.com/ET200SP-motorstarter
 Industry Mall, see www.siemens.com/product?3RK1308
 TIA Selection Tool, see www.siemens.com/TST

Further components in the ET 200SP I/O system:

- [Catalog ST 70](#)
- Industry Mall, see www.siemens.de/product?ET200SP

ET 200SP motor starters

ET 200SP is a scalable and extremely flexible modular I/O system with IP20 degree of protection.

As I/O modules, the ET 200SP motor starters are an integral part of this I/O system. They are switching and protection devices for single- and three-phase loads and are available as direct-on-line or reversing starters.

Basic functionality

All versions of the ET 200SP motor starter feature the following functionality:

- Fully pre-wired motor starters for switching and protecting any AC loads up to 5.5 kW from 48 V AC to 500 V AC
- Disconnection possible via fail-safe motor starters up to SIL 3 and PL e Cat. 4
- With self-assembling 32 A power bus, i.e. the load voltage is only fed in once for a group of motor starters
- All control supply voltages connected only once, i.e. when modules are added they are automatically connected to the next module
- Hot swapping is permissible
- Digital inputs can optionally be used via a 3DI/LC module
- Control of the motor starter from the control system and extensive diagnostics status via the cyclic process image
- Diagnostics capability for active monitoring of the switching and protection functions

- The signal states in the process image of the motor starter provide information about protective devices (short circuit or overload), the switching states of the motor starter, and system faults.

Starter Kit

The 3RK1908-1SK00 Starter Kit is a favorably priced complete package for switching and monitoring motors in the ET 200SP system, see [page 6/21](#).

It contains:

- a 3RK1308-0BC00-0CP0 reversing starter (0.9 to 3 A)
- a 3RK1908-0AP00-0AP0 BaseUnit with 500 V and 24 V AC/DC infeed
- an EMC distance module (consisting of 6ES7193-6BP00-0BA0 BaseUnit plus 6ES7133-6CV15-1AM0 BU cover 15 mm)

Use of fan

For motor starters with a 12 A rated current, the 3RW4928-8VB00 fan is included in the scope of supply.

This fan can also be ordered as an option for motor starters with lower rated currents, if the boundary conditions demand this. For information on the ambient conditions for the use of motor starters, see [chapter "Product overview" in the Equipment Manual](#).

ET 200SP motor starter

Introduction

Designing interference-free motor starters

For interference-free operation of the ET 200SP station in accordance with IEC 60947-4-2 standard, use a dummy module before the first motor starter. The dummy module consists of the 6ES7193-6BP00-0BA0 or 6ES7193-6BP00-0DA0 BaseUnit and the 6ES7133-6CV15-1AM0 BU cover 15 mm.

The 15 mm BU cover protects the plug contacts of the BaseUnit against dirt.

Electromechanical switching devices in series with hybrid motor starters

Switching an inductive load - in particular of motors <1 kW with high inductance - with an electromechanical switching device (e.g. contactor) can cause high and steep voltage edges.

The resulting faults/damage can be prevented by first disconnecting with the hybrid motor starter or by using EMC suppression modules:

- For 3RT2916-1P.. EMC suppression modules for direct mounting on the contactor, [see page 13/133](#).
- For motor suppression modules that are fitted in the main circuit, [see page 16/21](#).

Note:

For more information, [see https://support.industry.siemens.com/cs/ww/en/view/109758696](https://support.industry.siemens.com/cs/ww/en/view/109758696).

3DI/LC control module

This is a digital input module with three inputs for local motor starter functions such as “manual local control”, “implementation of fast inputs” or “end position disconnection”. For a list of all the functions permitted by the 3DI/LC module, [see chapter “Overview of functions” in the Equipment Manual](#).

The module is plugged into the front of the motor starter from which it is supplied with a 24 V DC operating voltage.

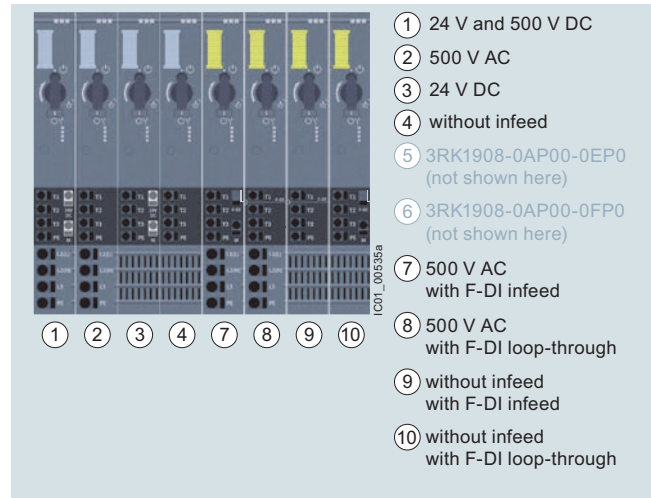
BaseUnits for motor starters

View of the BaseUnit infeeds for the motor starters

BaseUnits are components for accommodating the ET 200SP I/O modules.

The self-assembling voltage buses integrated into the BaseUnits reduce wiring outlay to the single infeed (both of auxiliary and load voltage).

All modules following on the right are automatically supplied upon plugging the BaseUnits together, if BaseUnits are inserted with routing.

The rugged design and keyed connection technology enables use in harsh industrial conditions.

The BaseUnits are available with various infeeds for the motor starters.

ET 200SP motor starter

General data

Article No. scheme

Product versions		Article number	
Motor starters		3RK1308 - 0	<input type="checkbox"/> <input type="checkbox"/> 0 0 - 0 C P 0
Product function	Direct-on-line starters	A	For motor standard output 0.09 ... 5.5 kW ¹⁾
	Reversing starters	B	For motor standard output 0.09 ... 5.5 kW ¹⁾
	Fail-safe direct-on-line starters	C	For motor standard output 0.09 ... 5.5 kW ¹⁾
	Fail-safe reversing starters	D	For motor standard output 0.09 ... 5.5 kW ¹⁾
Current range	0.1 ... 0.4 A	A	Maximum current-carrying capacity when starting 4 A
	0.3 ... 1 A	B	Maximum current-carrying capacity when starting 10 A
	0.9 ... 3 A	C	Maximum current-carrying capacity when starting 30 A
	2.8 ... 9 A	D	Maximum current-carrying capacity when starting 90 A
	4 ... 12 A	E	Including fan (3RW4928-8VB00), maximum current-carrying capacity when starting 100 A
Example		3RK1308 - 0 A D 0 0 - 0 C P 0	

¹⁾ For standard motors: Single- or three-phase asynchronous motors, single-phase AC motors, single-phase asynchronous motors, at 400 V AC and 500 V AC; the actual startup characteristics of the motor as well as its rated data are important factors here.

Product versions		Article number	
BaseUnit		3RK1908 - 0 A P 0 0 - 0	<input type="checkbox"/> P 0
BU infeed	24 V and 500 V AC	A	
	24 V DC	B	
	500 V AC	C	
	without infeed	D	
	500 V AC	G	with F-DI infeed
	500 V AC	H	with F-DI loop-through
	without infeed	J	with F-DI loop-through
	without infeed	K	with F-DI infeed
Example		3RK1908 - 0 A P 0 0 - 0 A P 0	

Note:

The article number schemes show an overview of product versions for better understanding of the logic behind the article numbers.

For your orders, please use the article numbers quoted in the selection and ordering data.

Benefits

Product advantages

The ET 200SP motor starters offer a number of advantages:

- Fully integrated into the ET 200SP I/O system (including TIA Selection Tool and TIA Portal)
- High degree of flexibility when it comes to safety applications via SIMATIC F-CPU or SIRIUS 3SK safety relays up to SIL 3 and PL e Cat. 4.
- Simple, integrated current value transmission
- Extensive parameterization by means of TIA Portal
- Increase of plant availability through fast replacement of units (easy mounting and plug-in technology)
- Greater endurance and reduced heat losses thanks to hybrid technology
- Less space required in the control cabinet (20 to 80%) as a result of greater functional density (direct-on-line and reversing starters in same width)
- Extensive diagnostics and information for preventive maintenance
- Parameterizable inputs via 3DI/LC control module
- Less wiring and testing required as a result of integrating several functions into a single device
- Lower overheads for stock keeping and configuration as a result of the wide setting range of the electronic overload release (up to 1:3)

- The ET 200SP motor starters can be used with highly energy efficient IE3/IE4 motors, [see Application Manual](#). Take the current characteristics of the connected motor and motor starter into account when dimensioning. In addition to the rated current, the maximum permissible current range of the motor starter and the ratio of the rated current to the starting current of the motor are relevant. For more information on IE3/IE4, [see page 1/7](#).

Standards and approvals

- IEC/EN 60947-4-2
- UL 60947-4-2
- CSA
- ATEX
- IEC 61508-1: SIL 3
- ISO 13849: PL e
- CCC approval for China

ET 200SP motor starter

General data

Application

The ET 200SP motor starters are suitable for the following applications:

- Switching and monitoring of
 - three-phase motors with overload and short-circuit protection (e.g. 400 V asynchronous motors for secondary drives in conveyor systems)
 - single-phase motors with overload and short-circuit protection (e.g. 230 V motors for pump applications)
 - Resistive loads by means of current value and diagnostics via the maintenance function (e.g. for heaters)
- Plant monitoring and energy management in conveyor systems:
 - By means of the phase asymmetry and zero current detection during current measurement, for example, drive belt monitoring and blocking monitoring are possible.

- Track switching and lifting table control in conveyor systems: Track switches can be implemented using the quick stop function and lifting table controls by means of the "immediate end position disconnection" function without any laborious programming.
- Safe isolation of the drive from main power supply: The isolating functions according to IEC 60947-1 offer protection against inadvertent activation during plant maintenance.

Motor starters in the process industry

For the ET 200SP motor starters, special BaseUnits are available that enable the device to be used in the ET 200SP HA I/O system, too. This is typically used in process engineering applications.

Technical specifications

More information

Industry Mall, see www.siemens.com/product?3RK1308
 Equipment Manual, see <https://support.industry.siemens.com/cs/ww/en/view/109479973>

FAQs, see <https://support.industry.siemens.com/cs/ww/en/ps/21800/faq>

ET 200SP motor starters

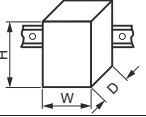
Article number		3RK1308-0AA00-0CP0	3RK1308-0AB00-0CP0	3RK1308-0AC00-0CP0	3RK1308-0AD00-0CP0	3RK1308-0AE00-0CP0
		3RK1308-0BA00-0CP0	3RK1308-0BB00-0CP0	3RK1308-0BC00-0CP0	3RK1308-0BD00-0CP0	3RK1308-0BE00-0CP0
Product category		Motor starters				
General technical specifications:						
Width x height x depth	mm	30 × 142 × 150				
						
Design of the switching contact		Hybrid				
Design of the motor protection		Electronic				
Installation altitude at height above sea level, maximum	m	4 000				
Mounting position		Vertical, horizontal, flat (observe derating)				
Type of mounting		Can be plugged into BaseUnit				
Ambient temperature						
• During operation	°C	-25 ... +60				
• During transport	°C	-40 ... +70				
• During storage	°C	-40 ... +70				
Relative humidity during operation	%	10 ... 95				
Vibration resistance		15 mm up to 6 Hz; 2 g up to 500 Hz				
Shock resistance		6 g / 11 ms				
Degree of protection		IP20				
Type of coordination		1				
Electrical data:						
Supply voltage at DC rated value	V	24				
Operational power for AC-53a at 400 V rated value	kW	0.12	0.25	1.1	4	5.5
Operating frequency, rated value	Hz	50 ... 60				
Ultimate short-circuit current breaking capacity (I_{cu})						
• at 400 V rated value	kA	55				
• at 500 V rated value	kA	55				
Adjustable current response value of the inverse-time delayed overload release	A	0.1 ... 0.4	0.3 ... 1	0.9 ... 3	2.8 ... 9	4 ... 12
Max. current carrying capacity at startup	A	4	10	30	90	100
Max. permissible voltage for protective separation between main and auxiliary circuit	V	500				
Insulation voltage, rated value	V	500				

ET 200SP motor starter

General data

ET 200SP fail-safe motor starters

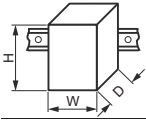
Article number		3RK1308-0CA00-0CP0	3RK1308-0CB00-0CP0	3RK1308-0CC00-0CP0	3RK1308-0CD00-0CP0	3RK1308-0CE00-0CP0
		3RK1308-0DA00-0CP0	3RK1308-0DB00-0CP0	3RK1308-0DC00-0CP0	3RK1308-0DD00-0CP0	3RK1308-0DE00-0CP0
Product category		Motor starters				
General technical specifications:						
Width x height x depth	mm	30 x 142 x 150				
						
Design of the switch contact		Hybrid				
Design of the motor protection		Electronic				
Installation altitude at height above sea level, maximum	m	2 000				
Mounting position		Vertical, horizontal, flat (observe derating)				
Type of mounting		Can be plugged into BaseUnit				
Ambient temperature						
• During operation	°C	-25 ... +60				
• During transport	°C	-40 ... +70				
• During storage	°C	-40 ... +70				
Relative humidity during operation	%	10 ... 95				
Vibration resistance		15 mm up to 6 Hz; 2 g up to 500 Hz				
Shock resistance		6 g / 11 ms				
Degree of protection		IP20				
Type of coordination		1				
Electrical data:						
Supply voltage at DC rated value	V	24				
Operational power for AC-53a at 400 V, rated value	kW	0.12	0.25	1.1	4	5.5
Operating frequency, rated value	Hz	50 ... 60				
Ultimate short-circuit current breaking capacity (I_{cu})						
• at 400 V rated value	kA	55				
• at 500 V rated value	kA	55				
Adjustable current response value of the inverse-time delayed overload release	A	0.1 ... 0.4	0.3 ... 1	0.9 ... 3	2.8 ... 9	4 ... 12
Max. current carrying capacity at startup	A	4	10	30	90	100
Max. permissible voltage for protective separation between main and auxiliary circuit	V	500				
Insulation voltage, rated value	V	500				
Trip class		CLASS 5 and 10 adjustable				

ET 200SP motor starter

General data

BaseUnits for motor starters

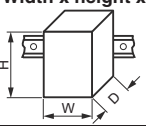
Article number	3RK1908-0AP00-0AP0	3RK1908-0AP00-0BP0	3RK1908-0AP00-0CP0	3RK1908-0AP00-0DP0	3RK1908-0AP00-0GP0	3RK1908-0AP00-0HP0	3RK1908-0AP00-0JP0	3RK1908-0AP00-0KP0
Product designation	BaseUnit							
General technical specifications:								
Width x height x depth	mm	30 x 215 x 75						
								
Ambient temperature								
• During operation	°C	-25 ... +60						
• During transport	°C	-40 ... +70						
• During storage	°C	-40 ... +70						
Degree of protection		IP20						
Touch protection against electric shock		Finger-safe						
Connections/terminals:								
Type of connectable conductor cross-sections								
• At the inputs for supply voltage								
- Solid		1 x 0.5 ... 2.5 mm ²	--	--	--	--	--	--
- Finely stranded with end sleeve		1 x 0.5 ... 2.5 mm ²	--	--	--	--	--	--
- Finely stranded without end sleeve		1 x 0.5 ... 2.5 mm ²	--	--	--	--	--	--
- Solid for AWG cables		1 x 20 ... 12	--	--	--	--	--	--
• For infeed								
- Solid		1 x 1 ... 6 mm ²	--	1 x 1 ... 6 mm ²	--	1 x 1 ... 6 mm ²	--	1 x 1 ... 6 mm ²
- Finely stranded with end sleeve		1 x 1 ... 6 mm ²	--	1 x 1 ... 6 mm ²	--	1 x 1 ... 6 mm ²	--	1 x 1 ... 6 mm ²
- Finely stranded without end sleeve		1 x 1 ... 6 mm ²	--	1 x 1 ... 6 mm ²	--	1 x 1 ... 6 mm ²	--	1 x 1 ... 6 mm ²
- Solid for AWG cables		1 x 18 ... 10	--	1 x 18 ... 10	--	1 x 18 ... 10	--	1 x 18 ... 10
• For load-side outgoing feeder								
- Solid		1 x 0.5 ... 2.5 mm ²	--	--	--	--	--	--
- Finely stranded with end sleeve		1 x 0.5 ... 2.5 mm ²	--	--	--	--	--	--
- Finely stranded without end sleeve		1 x 0.5 ... 2.5 mm ²	--	--	--	--	--	--
- Solid for AWG cables		1 x 20 ... 12	--	--	--	--	--	--
Type of electrical connection for auxiliary and control circuits		Spring-loaded terminals (push-in)						
Miscellaneous:								
Type of screwdriver tip		Slotted						
Size of screwdriver tip		Standard screwdriver 0.6 mm x 3.5 mm						

General data

3DI/LC control module

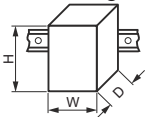
Article number	3RK1908-1AA00-0BP0	
Product designation	3DI/LC control module	
General technical specifications:		
Width x height x depth	mm	30 × 54.5 × 42.3
		
Type of product	Accessories	
Number of digital inputs	4	
Installation altitude at height above sea level, maximum	m	2 000
Mounting position	Vertical, horizontal, flat	
Type of mounting	Can be plugged onto motor starter	
Ambient temperature		
• During operation	°C	-25 ... +60
• During transport	°C	-40 ... +70
• During storage	°C	-40 ... +70
Connections/terminals:		
Connectable conductor cross-section for auxiliary contacts		
• Solid or stranded	mm ²	0.2 ... 1.5
• Finely stranded with end sleeve	mm ²	0.25 ... 1.5
• Finely stranded without end sleeve	mm ²	0.2 ... 1.5
AWG number as coded connectable conductor cross-section	24 ... 16	
Type of electrical connection for auxiliary and control circuits	Spring-loaded terminals (push-in)	
Electrical data:		
Type of voltage of the control supply voltage	DC	
Control supply voltage at DC rated value	V	20.4 ... 28.8
Miscellaneous:		
Type of screwdriver tip	Slotted	
Size of screwdriver tip	Standard screwdriver 0.6 mm x 3.5 mm	

ET 200SP motor starter

Selection and ordering data **IE3/IE4 ready**

Selection and ordering data

Adjustable current response value of the inverse-time delayed overload release	Max. current carrying capacity at startup at 480V	SD	Article No.	Price per PU	PU (UNIT, SET, M)	PS*
A	A	d				

Motor starters

Direct-on-line starters



3RK1308-0AB00-0CP0

0.1 ... 0.4	3.2	NEW 2	3RK1308-0AA00-0CP0		1	1 unit
0.3 ... 1	8	2	3RK1308-0AB00-0CP0		1	1 unit
0.9 ... 3	24	2	3RK1308-0AC00-0CP0		1	1 unit
2.8 ... 9	72	2	3RK1308-0AD00-0CP0		1	1 unit
4 ... 12	72	2	3RK1308-0AE00-0CP0		1	1 unit

Reversing starters



3RK1308-0BB00-0CP0

0.1 ... 0.4	3.2	NEW 2	3RK1308-0BA00-0CP0		1	1 unit
0.3 ... 1	8	2	3RK1308-0BB00-0CP0		1	1 unit
0.9 ... 3	24	2	3RK1308-0BC00-0CP0		1	1 unit
2.8 ... 9	72	2	3RK1308-0BD00-0CP0		1	1 unit
4 ... 12	72	2	3RK1308-0BE00-0CP0		1	1 unit

Fail-safe direct-on-line starters



3RK1308-0CE00-0CP0

0.1 ... 0.4	3.2	NEW 2	3RK1308-0CA00-0CP0		1	1 unit
0.3 ... 1	8	2	3RK1308-0CB00-0CP0		1	1 unit
0.9 ... 3	24	2	3RK1308-0CC00-0CP0		1	1 unit
2.8 ... 9	72	2	3RK1308-0CD00-0CP0		1	1 unit
4 ... 12	72	2	3RK1308-0CE00-0CP0		1	1 unit

Fail-safe reversing starters



3RK1308-0DE00-0CP0

0.1 ... 0.4	3.2	NEW 2	3RK1308-0DA00-0CP0		1	1 unit
0.3 ... 1	8	2	3RK1308-0DB00-0CP0		1	1 unit
0.9 ... 3	24	2	3RK1308-0DC00-0CP0		1	1 unit
2.8 ... 9	72	2	3RK1308-0DD00-0CP0		1	1 unit
4 ... 12	72	2	3RK1308-0DE00-0CP0		1	1 unit

ET 200SP motor starter

Base units and control module

Type of product	Operational voltage of the AC infeed	Supply voltage of the DC infeed	SD	Push-in terminals	Price per PU	PU (UNIT, SET, M)	PS*
	V	V	d	Article No.			

BaseUnits¹⁾



3RK1908-0AP00-0AP0

For motor starters

• with AC/DC infeed	500	24	2	3RK1908-0AP00-0AP0		1	1 unit
• with DC infeed	--	24	2	3RK1908-0AP00-0BP0		1	1 unit
• with AC infeed	500	--	2	3RK1908-0AP00-0CP0		1	1 unit
• without infeed	--	--	2	3RK1908-0AP00-0DP0		1	1 unit

For fail-safe motor starters **NEW**

• with AC infeed, with F-DI infeed for fail-safe motor starters	500	--	2	3RK1908-0AP00-0GP0		1	1 unit
• with AC infeed, with F-DI loop-through for fail-safe motor starters	500	--	2	3RK1908-0AP00-0HP0		1	1 unit
• without AC/DC infeed, with F-DI loop-through for fail-safe motor starters	--	--	2	3RK1908-0AP00-0JP0		1	1 unit
• without AC/DC infeed, with F-DI infeed for fail-safe motor starters	--	--	2	3RK1908-0AP00-0KP0		1	1 unit

¹⁾ The voltage is looped-through from BaseUnits with infeed to subsequent BaseUnits without infeed.

Type of product	Supply voltage at DC rated value	Loop through the potential group from the left	SD	Push-in terminals	Price per PU	PU (UNIT, SET, M)	PS*
	V		d	Article No.			

BaseUnits



6ES7193-6BP00-0BA0

For dummy modules

• dark, looping through the potential group	24	Yes	1	6ES7193-6BP00-0BA0		1	1 unit
• light, opening a new potential group	24	No	1	6ES7193-6BP00-0DA0		1	1 unit

Control supply voltage at DC rated value	Product function	SD	Push-in terminals	Price per PU	PU (UNIT, SET, M)	PS*
V	Local control Digital inputs parameterizable	d	Article No.			

3DI/LC control module



3RK1908-1AA00-0BP0

20.4 ... 28.8	Yes Yes	2	3RK1908-1AA00-0BP0		1	1 unit
---------------	-----------	---	---------------------------	--	---	--------

ET 200SP motor starter

Accessories

	Product designation	Type of product	SD d	Article No.	Price per PU	PU (UNIT, SET, M)	PS*
Accessories							
	BU cover 15 mm	for BaseUnits Type A0 or A1	1	6ES7133-6CV15-1AM0		1	5 units
6ES7133-6CV15-1AM0							
	BU cover 30 mm	For protection of empty slots, 30 mm	2	3RK1908-1CA00-0BP0		1	1 unit
3RK1908-1CA00-0BP0							
	Infeed bus cover (1 bag containing 10 covers)	For ET 200SP	2	3RK1908-1DA00-2BP0		1	1 unit
3RK1908-1DA00-2BP0							
	Mechanical bracket (1 bag containing 5 mechanical brackets)	Mechanical, for ET 200SP	2	3RK1908-1EA00-1BP0		1	1 unit
3RK1908-1EA00-1BP0							
	Fan	Can be used for 3RK1308	▶	3RW4928-8VB00		1	1 unit
3RW4928-8VB00							
	Motor suppression module • Square		15	3RK1911-6EA00		1	1 unit
3RK1911-6EA00							
	• Round		15	3RK1911-6EB00		1	1 unit
3RK1911-6EB00							
	Starter Kit NEW	consists of 3RK1308-0BC00-0CP0 reversing starter (0.9 ... 3 A), 3RK1908-0AP00-0AP0 BaseUnit with 500 V and 24 V AC/DC infeed, and EMC distance module (consisting of 6ES7193-6BP00-0BA0 BaseUnit plus 6ES7133-6CV15-1AM0 BU cover 15 mm)	5	3RK1908-1SK00		1	1 unit
3RK1908-1SK00							

Overview

Flexible and cost-efficient distributed starter solutions

Be it their high degree of protection, compact design or integrated multifunctionality – our motor starters and soft starters for use in the field are ideal for realizing distributed drive solutions. The modular concepts, distributed power supply and integrated safety technology of our portfolio for a high degree of protection consistently supports current trends in drive technology.



3RK1304



3RK1315

	Type	Page
ET 200pro motor starters		
Motor starters in the SIMATIC ET 200pro I/O system up to 5.5 kW		
Standard motor starters	3RK1304	6/28
High Feature motor starters	3RK1304	6/29
ET 200pro isolator modules	• With switch disconnecter function for safe disconnection 3RK1304	6/30
Safety modules local	• Isolator module, 400 V disconnecting module 3RK1304	6/31
Safety modules PROFIsafe	• F-Switch PROFIsafe 6ES7148	6/34
Accessories for ET 200pro motor starters	• Incoming power supply, power loop-through connection on the field device, motor cable, power bus with power terminal connectors 3RK19	6/35
ET 200pro – interface modules	• For communication with PROFIBUS, PROFINET and IWLAN 6ES71	ST 70
ET 200pro – CPUs	• Standard CPUs, fail-safe CPUs 6ES71	ST 70
ET 200pro – I/O modules	• Digital/analog expansion modules, fail-safe expansion modules, power modules, ET 200pro pneumatic interfaces 6ES71	ST 70
ET 200pro PS	• Stabilized power supplies 6ES7148	ST 70
ET 200pro FC-2 frequency converters	6SL35	D 31.2
ET 200pro add-on products	• Modules for EtherNet/IP ZNX:EIP	ST 70
SIRIUS M200D motor starters		
Distributed motor starters up to 5.5 kW		
M200D AS-i Basic motor starters	3RK1315	6/47
M200D AS-i Standard motor starters	3RK1325	6/48
M200D communication modules for PROFIBUS	3RK1305	6/55
M200D communication modules for PROFINET	3RK1335	6/55
M200D motor starter modules	3RK1395	6/55
Accessories	• Incoming power supply, motor cable, power bus with power terminal connectors 3RK1911	6/59
	• Motor control with I/O communication 3RK1902	6/61
	• Motor control with AS-i communication 3RK1902	6/62
	• Motor control with PROFIBUS 3RK1902	6/64
	• Motor control with PROFINET 3RK1902	6/65
Hybrid fieldbus connections		
	• Passive and active 3RK1911	6/67

ET 200pro motor starter

General data

Overview

ET 200pro motor starters in I/O system ET 200pro

SIMATIC ET 200pro is the modular I/O system with high degree of protection IP65/66/67 for local, cabinet-free use. The ET 200pro motor starters with the high degree of protection IP65 are an integral part of ET 200pro.



ET 200pro motor starter: Isolator module, Standard starter and High Feature starter mounted on a wide module rack

ET 200pro motor starters (see pages 6/28 and 6/29)

- Only two variants up to 5.5 kW
- All settings can be parameterized by bus
- Comprehensive diagnostic signals
- Support for PROFIenergy
- Overload can be acknowledged by remote RESET
- Current asymmetry monitoring
- Stall protection
- EMERGENCY START function on overload
- Current value transmission by bus
- Current limit monitoring
- Full support of acyclic services
- Direct-on-line or reversing starters
- Power bus connection can be plugged in using Han Q4/2 connectors
- Motor feeder with Han Q8/0 plug
- Conductor cross-section up to 6 x 4 mm²
- 25 A per segment (power looped through using jumper plug)
- In the Standard and High Feature versions (with 4 DI on-board)
- Electromechanical switching and electronic switching
- Electronic starter for direct activation or with integrated soft starter function
- Supplied with 400 V AC brake contact as an option
- Temperature sensor can be connected (Thermoclick or PTC type A)
- Provision of the motor current in PROFIenergy format to higher-level systems, motor current shutdown in dead times using PROFIenergy

More information

Homepage, see www.siemens.com/ET200pro

Industry Mall, see www.siemens.com/product?ET200pro

Further components in the ET 200pro distributed I/O system:

- Interface modules, central units, I/O modules, ET 200pro PS, see [Catalog ST 70](#)
- ET 200pro FC-2 frequency converters, see [Catalog D 31.2](#)

ET 200pro isolator modules (see page 6/30)

The isolator module with switch disconnecter function is used for safe disconnection of the 400 V operational voltage during repair work in the plant and provides an integrated group fusing function (i.e. additional group short-circuit protection for all subsequently supplied motor starters).

Depending on the power distribution concept, all stations can be equipped with an isolator module as an option.

Safety applications

Safety Solution local (see page 6/31)

With the Safety local modules

- Safety local isolator module and
- 400 V disconnecting module with an appropriate connection, safety level PL e (according to ISO 13849-1) can be reached.

Safety Solution PROFIsafe (see page 6/34)

With the Safety PROFIsafe modules

- F-Switch and
- 400 V disconnecting module with an appropriate connection, safety levels SIL 3 (according to IEC 62061) and PL e (according to ISO 13849-1) can also be reached.

Functionality

With the ET 200pro motor starters, any three-phase loads can be protected and switched.

The ET 200pro motor starters are available with mechanical and also electronic contacts.

The ET 200pro electromechanical starters are offered as direct-on-line starters (DSe) and reversing starters (RSe) as **Standard** and **High Feature** versions. There are device versions with or without control for externally fed brakes with 400 V AC.

Compared with the Standard motor starters, the **High Feature, mechanical** motor starter also has:

- Four digital inputs
- Advanced parameterization options

The ET 200pro electronic starters are offered as direct-on-line starters (sDSSSte/sDSte) and reversing starters (sRSSSte/sRSte) in the High Feature version.

Compared with the High Feature mechanical motor starters, the **High Feature electronic** motor starter also has:

- Soft starting and smooth ramp-down function
- Deactivated soft start function as an electronic starter for applications with a high switching frequency
- Advanced parameterization options

ET 200pro motor starter

General data

As a result of the protection concept with solid-state overload evaluation and the use of SIRIUS switching devices, size S00, additional advantages are realized on the Standard and High Feature motor starters – advantages that soon make themselves positively felt particularly in manufacturing processes with high plant stoppage costs:

- Configuration is made easier and flexibility is increased by the fine modular structure with ET 200pro. When using ET 200pro motor starters, the parts list per load feeder is reduced to two main items: the bus module and the motor starter. This makes the ET 200pro ideal for modular machine concepts or solutions for conveying systems and in machine-tool building.

- Expansions are easily possible through the subsequent adding of modules. The innovative plug-in technology also does away with the wiring needed up to now. Through the hot swapping function (disconnection and connection during operation) a motor starter can be replaced within seconds if necessary, without having to shut down the ET 200pro station and with it the process in the plant. The motor starters are therefore recommendable in particular for applications with special demands on availability. Storage costs are also optimized by the low level of variance (two units up to 7.5 HP).
- With four locally acting inputs available on the High Feature motor starter it is possible to realize autonomous special functions that work independently of the bus and the higher level control system, e.g. as a quick stop on gate valve controls or limit position disconnectors. In parallel with this, the states of these inputs are signaled to the control system.

Article No. scheme

Product versions		Article number				
Motor starters		3RK1304	-	5	<input type="checkbox"/> S <input type="checkbox"/> 0	<input type="checkbox"/> A <input type="checkbox"/> A <input type="checkbox"/>
Setting range	0.15 ... 2.0 A 1.5 ... 12 A	K				
		L				
Product function	Direct-on-line starters DSe		4	4		Standard
	Reversing starters RSe		4	5		Standard
	Direct-on-line starters DSe		4	2		High Feature
	Reversing starters RSe		4	3		High Feature
	Direct-on-line starters sDSSSte/sDSte		7	2		High Feature
	Reversing starters sDSSSte/sDSte		7	3		High Feature
Inputs/outputs	Without brake output					0
	With brake output					3 400 V AC, with High Feature + 4 inputs
Example		3RK1304	-	5	K S 4 0	- 4 A A 0

Product versions		Article number				
Modules		3RK1304	-	0	H S 0 0	<input type="checkbox"/> A <input type="checkbox"/> A <input type="checkbox"/> 0
Product function	Isolator modules					6
	Isolator modules					7 Safety modules local
	400 V disconnecting modules					8 Safety modules local/PROFIsafe
Example		3RK1304	-	0	H S 0 0	- 6 A A 0

Note:

The Article No. scheme shows an overview of product versions for better understanding of the logic behind the article numbers.

For your orders, please use the article numbers quoted in the selection and ordering data.

Type Technology designation ¹⁾	Standard motor starters DSe, RSe		High Feature motor starters DSe, RSe	
			sDSSSte, sDStSe, sRSSSte, sRStSe	
Device functions (firmware features)				
Parameterizable rated operational current		✓		
Integrated short-circuit protection		✓		
Parameterizable current limit values		--	✓ 2 limit values	
Parameterizable response in case of current limit violation		--	✓	
Zero current monitoring		✓		
Parameterizable response in case of zero current violation		✓		
Parameterizable current asymmetry limit	%	-- Fixed limit value (30 x I _e)	✓ 30 ... 60 x I _e	
Parameterizable response in case of asymmetry limit violation		✓		
Motor blocking monitoring		--	✓	
Parameterizable blocking current limit	%	--	✓ 150 ... 1 000 x I _e	
Parameterizable blocking time limit	s	--	✓ 1 ... 5	
Current value transmission		✓		
Group warning diagnostics		--	✓ Parameterizable	
Group diagnostics		✓ Parameterizable		
EMERGENCY START		✓		
Digital inputs		--	✓ 4 inputs	
• Parameterizable input signal		--	✓ Latching/non-latching	
• Parameterizable input level		--	✓ NC/NO contacts	
• Parameterizable input signal delay	ms	--	✓ 10 ... 80	
• Parameterizable input signal extension	ms	--	✓ 0 ... 200	
• Parameterizable input control actions		--	✓ 12 different actions	
Brake output (400 V AC)		✓ Order option		
Parameterizable brake enabling delay	s	✓ -2.5 ... +2.5		
Parameterizable holding time of the brake during stopping	s	✓ 0 ... 25		
Parameterizable startup type		--		✓
Parameterizable ramp-down time		--		✓
Parameterizable starting voltage		--		✓
Parameterizable stopping voltage		--		✓
Local device interface		✓		
Firmware update		✓ By specialists		
Thermal motor model		✓		
Parameterizable trip class		-- CLASS 10 fixed	✓ CLASS 5, 10, 15, 20	
Parameterizable response in case of overload of thermal motor model		--	✓ 3 possible states	
Advance warning limit for motor heating	%	--	✓ Parameterizable 0 ... 95	
Advance warning limit time-related trip reserve	s	--	✓ Parameterizable 0 ... 500	
Parameterizable recovery time	min	--	✓ 1 ... 30	
Parameterizable protection against voltage failure		-- Permanently integrated	✓	
Reversing start function		✓ Order option		
Parameterizable interlock time for reversing starters		-- 150 ms fixed	✓ 0 ... 60 s	
Integrated logbook functions		✓ 3 device logbooks		
Integrated statistics data memory		✓		
Parameterizable response in case of CPU/master stop		✓		
PROFenergy profile support		✓		
• Disconnection of the motor current during idle times		✓		
• Measured motor current values		✓		
Device indications				
• Group fault		SF LED (red)		
• Switching state		STATE LED (red, yellow, green)		
• Device status		DEVICE LED (red, yellow, green)		
• Digital inputs		--	IN 1 ... IN 4, LED	

✓ Function available

-- Function not available

- ¹⁾ DS Direct-on-line starters
 RS Reversing starters
 DSS .. Direct-on-line soft starters
 RSS .. Reversing soft starters
 e Electronic motor protection
 te Full motor protection (thermal + electronic)
 s Electronic switching with semiconductor.

ET 200pro motor starter

General data

Benefits

ET 200pro motor starters provide the following advantages:

- High flexibility thanks to a modular and compact design
- Little variance among all motor starter versions (two units up to 5.5 kW)
- Extensive parameterization using STEP 7 HW Config
- Increase of plant availability through fast replacement of units (easy mounting and plug-in technology)
- Extensive diagnostics and information for preventive maintenance
- Parameterizable inputs for on-site control functions (High Feature)
- Cabinet-free design thanks to high degree of protection IP65

Application

The SIMATIC ET 200pro motor starters are ideal for the use of several spatially concentrated distributed drive solutions in which several motors, or digital or analog sensors and actuators are addressed from a distributed station. They are perfectly suited for protecting and switching any AC loads.

Application areas

The SIMATIC ET 200pro motor starters are suitable for numerous sectors of industry, e.g. machinery and plant engineering or conveying applications.

Use of ET 200pro motor starters in conjunction with IE3/IE4 motors

Note:

For the use of ET 200pro motor starters in conjunction with highly energy-efficient IE3/IE4 motors, please observe the information on dimensioning and configuring; see [Application Manual](#).

ET 200pro motor starter

General data

Technical specifications

More information

Equipment Manual, see <https://support.industry.siemens.com/cs/ww/en/view/22332388>

Notes on security:

System networking requires suitable protective measures (including network segmentation for IT security) in order to ensure safe plant operation. For more information on the subject of Industrial Security, see www.siemens.com/industrialsecurity.

Type	Standard motor starters		High Feature motor starters	
	Mechanical switching without inputs		Mechanical switching with inputs	Electronic switching with inputs and soft starter function
Technology designation ¹⁾	DSe, RSe		DSe, RSe	sDSSte, sDSte, sRSSte, sRSte
Mechanics and environment				
Motor starters or modules that can be connected to ET 200pro With width of 110 mm	max. 8			
Mounting dimensions (W x H x D) • Direct-on-line starters and reversing starters	mm	110 x 230 x 150		110 x 230 x 160
Permissible ambient temperature • During operation • During storage	°C	-25 ... +55, from +40 with derating		
	°C	-40 ... +70		
Permissible mounting position	Vertical, horizontal			
Vibration resistance acc. to IEC 60068, Part 2-6	g	2		
Shock resistance acc. to IEC 60068, Part 2-27	g/ms	Half-sine 15/11		
Degree of protection	IP65			
Pollution degree	3, IEC 60664 (IEC 61131)			
Electrical specifications				
Power consumption at 24 V DC • From auxiliary circuit L+M (U1) • From auxiliary circuit A1/A2 (U2)	mA	Approx. 40		
	mA	Approx. 200		
Rated operational current I_e for power bus	A	25		
Rated operational voltage U_e • Approval according to EN 60947-1, Appendix N • Approval according to CSA and UL	V AC	400 (50/60 Hz)		Up to 400 (50/60 Hz) Up to 480 (50/60 Hz)
	V AC	Up to 400 (50/60 Hz)		
	V AC	Up to 600 (50/60 Hz)		
Approval • DIN VDE 0106, Part 101 • CSA and UL approval	V	Up to 400		Up to 480 Up to 480
	V	Up to 600		
Conductor cross-sections • Incoming power supply	mm ²	Max. 6 x 4		
Touch protection	Finger-safe			
Rated impulse withstand voltage U_{imp}	kV	6		
Rated insulation voltage U_i	V	400		
Rated operational current I_e for starters • AC-1 / 2 / 3 at 40 °C - At 400 V - At 500 V • AC-4 at 40 °C - At 400 V	A	0.15 ... 2.0/1.5 ... 12.0		0.15 ... 2.0/1.5 ... 12.0 ²⁾
	A	0.15 ... 2.0/1.5 ... 9.0		
	A	0.15 ... 2.0/1.5 ... 4.0		
Rated short-circuit breaking capacity	kA	100 at 400 V		
Type of coordination acc. to IEC 60947-4-1	1			
Power of three-phase motors at 400 V	kW	Max. 5.5		Max. 5.5/4 ³⁾
Utilization categories	AC-1, AC-2, AC-3, AC-4			AC-53a ⁴⁾ (max. 9 A with deactivated soft start function up to CLASS 10)
Protective separation between main and auxiliary circuits	V	400, acc. to EN 60947-1, Appendix N		
Endurance of contactor • Mechanical • Electrical	Operating cycles	30 million		--
	Operating cycles	Up to 10 million; depending on the current loading (see manual)		--
Permissible switching frequency	Depending on the current loading, motor starting time, and relative ON period (see manual)			
Operating times for 0.85 ... 1.1 x U_e • Closing delay • Opening delay	ms	11 ... 50		--
	ms	5 ... 45		--

¹⁾ DS ... Direct-on-line starters
RS ... Reversing starters
DSS .. Direct-on-line soft starters
RSS .. Reversing soft starters
e Electronic motor protection
te Full motor protection (thermal + electronic)
s Electronic switching with semiconductor.

²⁾ If the soft starter control function is deactivated, the permissible rated operational current is reduced to 9 A up to CLASS 10.
³⁾ With parameterization as electronic starter max. 4 kW.
⁴⁾ 8-hour operation.

ET 200pro motor starter

Standard motor starter **IE3/IE4 ready**

Overview

The functionality, device functions, and technical specifications of the Standard motor starter are described in "ET 200pro Motor Starters, General data" [see page 6/23 onwards](#).

Selection and ordering data

Version	SD	Article No.	Price per PU	PU (UNIT, SET, M)	PS*
	d				

Standard motor starters, mechanical Motor protection: thermal model



DSe Standard

DSe direct-on-line starters¹⁾

- Without brake output
- With brake output 400 V AC

RSe reversing starters¹⁾

- Without brake output
- With brake output 400 V AC

Setting range
Rated operational current

- 0.15 ... 2.0 A
- 1.5 ... 12.0 A

2	3RK1304-5□S40-4AA0	1	1 unit
2	3RK1304-5□S40-4AA3	1	1 unit
2	3RK1304-5□S40-5AA0	1	1 unit
2	3RK1304-5□S40-5AA3	1	1 unit

K
L

Additional price
None
✓

✓ = Additional price

¹⁾ Only functions when used together with the backplane bus module and the wide module rack. The backplane bus module and the wide module rack must be ordered separately (see "Accessories for ET 200pro motor starters", page 6/39).

ET 200pro motor starter

High Feature motor starter **IE3/IE4 ready**

Overview

The functionality, device functions, and technical specifications of the High Feature motor starter are described in "ET 200pro Motor Starters, General data" see page 6/23 onwards.

The High Feature motor starter differs from the Standard motor starter in having more parameters and four integrated, freely-parameterizable digital inputs.

Selection and ordering data

Version	SD	Article No.	Price per PU	PU (UNIT, SET, M)	PS*
---------	----	-------------	--------------	-------------------	-----

High Feature motor starters, mechanical Motor protection: thermal model



RSe High Feature

DSe direct-on-line starters¹⁾

- Without brake output and with 4 inputs
- With brake output 400 V AC and 4 inputs

2	3RK1304-5□S40-2AA0	1	1 unit
5	3RK1304-5□S40-2AA3	1	1 unit

RSe reversing starters¹⁾

- Without brake output and with 4 inputs
- With brake output 400 V AC and 4 inputs

2	3RK1304-5□S40-3AA0	1	1 unit
2	3RK1304-5□S40-3AA3	1	1 unit

Setting range
Rated operational current

- 0.15 ... 2.0 A
- 1.5 ... 12.0 A

Additional price
None
✓

K
L

High Feature motor starters²⁾, electronic Full motor protection, comprising thermal motor protection and thermistor motor protection



sRSSt High Feature

sDSSte/sDSte direct-on-line starters¹⁾²⁾

- Without brake output and with 4 inputs
- With brake output 400 V AC and 4 inputs

2	3RK1304-5□S70-2AA0	1	1 unit
5	3RK1304-5□S70-2AA3	1	1 unit

Reversing starters sRSSt/sRSt¹⁾²⁾

- Without brake output and with 4 inputs
- With brake output 400 V AC and 4 inputs

2	3RK1304-5□S70-3AA0	1	1 unit
2	3RK1304-5□S70-3AA3	1	1 unit

Setting range
Rated operational current

- 0.15 ... 2.0 A
- 1.5 ... 12.0 A

Additional price
None
✓

K
L

✓ = Additional price

¹⁾ Only functions when used together with the backplane bus module and the wide module rack. The backplane bus module and the wide module rack must be ordered separately (see "Accessories for ET 200pro motor starters", page 6/39).

²⁾ The electronic motor starters can be used not only as electronic motor starters with a high level of switching frequency but also as fully fledged soft starters for soft starting and stopping. The changeover from motor starter to soft starter takes place through reparameterization in HW Config. Depending on the setting, this results in the following current ranges:
- Parameterization as electronic motor starter: 0.15 to 2 A and 1.5 to 9 A (4 kW)
- Parameterization as soft starter: 0.15 to 2 A and 1.5 to 12 A (5.5 kW).

ET 200pro motor starter

Isolator modules **IE3/IE4 ready**

Overview

The isolator module with integrated group fusing function (i.e. additional group short-circuit protection for all subsequently supplied motor starters) and switch disconnecter function is used for safe disconnection of the 400 V operational voltage in the plant.

Depending on the power distribution concept, all stations can be equipped with an isolator module as an option.

The following properties apply to the isolator module:

- Increase of plant availability through fast replacement of units (easy mounting and plug-in technology)
- Cabinet-free design thanks to high degree of protection IP65

The isolator module is available in addition in a safety version (see "Safety local isolator module" on page 6/31).

Technical specifications

Type	Isolator modules	
General data		
Mounting dimensions (W x H x D)		
• Direct-on-line starters and reversing starters	mm	110 x 230 x 170
Permissible ambient temperature		
• During operation	°C	-25 ... +55
• During storage	°C	-40 ... +70
Permissible mounting position	Any	
Vibration resistance acc. to IEC 60068 Part 2-6	g	2
Shock resistance acc. to IEC 60068 Part 2-27	g/ms	Half-sine 15/11
Power consumption		
• From auxiliary circuit L+/M (U1)	mA	Approx. 20
• From auxiliary circuit A1/A2 (U2)		--
Rated operational current I_e for power bus	A	25
Rated operational voltage U_e	V	400
Approvals according to		
• DIN VDE 0106, Part 101	V	Up to 500
• CSA and UL	V	Up to 600
Conductor cross-sections		
• Incoming power supply	mm ²	Max. 6 x 4

Type	Isolator modules	
Degree of protection	IP65	
Touch protection	Finger-safe	
Pollution degree	3, IEC 60664 (IEC 61131)	
Rated impulse withstand voltage U_{imp}	kV	6
Rated insulation voltage U_i	V	400
Rated operational current I_e for starters		
• AC-1/2/3 at 40 °C		
- At 400 V	A	25
- At 500 V	A	25
Rated short-circuit breaking capacity	kA	50 at 400 V
Type of coordination acc. to IEC 60947-4-1	2	
Protective separation between main and auxiliary circuits	V	400, according to DIN VDE 0106, Part 101
Device functions		
• Group diagnostics	Yes, parameterizable	
Device indications		
• Group fault	SF LED (red)	

Selection and ordering data

Version	SD	Article No.	Price per PU	PU (UNIT, SET, M)	PS*
	d				

ET 200pro isolator modules, mechanical



3RK1304-0HS00-6AA0

Isolator modules¹⁾

Rated operational current 25 A

2

3RK1304-0HS00-6AA0

1

1 unit

¹⁾ Only functions when used together with the related 110 mm backplane bus module and the wide module rack. The backplane bus module and the wide module rack must be ordered separately (see page 6/39).

Overview**Safety Solution local**

With the Safety local modules

- Safety local isolator module and
 - 400 V disconnecting module
- with an appropriate connection, safety level PL e (according to ISO 13849-1) can be reached.

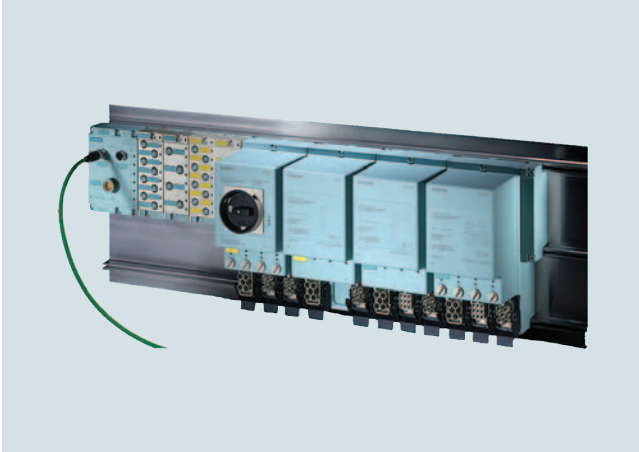

ET 200pro motor starter (Safety Solution local): Safety local isolator module, disconnecting module, Standard starter and High Feature starter mounted on a wide module rack

Safety local isolator module

The Safety local isolator module is a repair switch with integrated safety evaluation functions that can be parameterized using DIP switches.

It is used for

- Connection of a one- or two-channel EMERGENCY STOP circuit up to PL e (protective door or EMERGENCY STOP pushbuttons) and parameterizable start behavior
- For controlling the 400 V disconnecting module by means of a safety rail signal

400 V disconnecting module

The 400 V disconnecting module enables the safe disconnection of an operational voltage of 400 V up to PL e. For operation in a Safety Solution local application, it functions only in combination with the Safety local isolator module.

For operation in a Safety PROFIsafe application it functions only in combination with the F-Switch.

Functionality**Safety local isolator module**

The Safety local isolator module features the same functions as a standard isolator module with an additional local safety function.

The Safety local isolator module contains a 3TK2841 module and is equipped with M12 terminals for the connection of external safety components.

Terminals 1 and 2 can be used to connect either one- or two-channel EMERGENCY STOP circuits or protective door circuits (IN 1, IN 2).

For monitored starts, an external START switch can be connected to terminal 3.

The required safety functions can be set using two slide switches located under the left M12 opening.

In the event of an EMERGENCY STOP, the Safety local isolator module trips the downstream 400 V disconnecting module. This safely separates the 400 V circuit up to PL e.

In combination with the 400 V disconnecting module, the Safety local isolator module can be used for safety applications up to PL e.

400 V disconnecting module

The 400 V disconnecting module can be used together with the Safety local isolator module for local safety applications and together with the F-Switch for PROFIsafe safety applications.

It contains two contactors connected in series for safety-related disconnection of the main circuit.

The auxiliary circuit supply of the device is over a safety power rail in the backplane bus module.

The 400 V disconnecting module can be used in conjunction with the Safety local isolator module or with the F-Switch for safety applications up to PL e.

Technical specifications

Type		Safety local isolator module	400 V disconnecting module
General data			
Mounting dimensions (W x H x D)			
• Direct-on-line starters and reversing starters	mm	110 x 230 x 170	110 x 230 x 150
Permissible ambient temperature			
• During operation	°C	-25 ... +55	
• During storage	°C	-40 ... +70	
Permissible mounting position		Any	
Vibration resistance acc. to IEC 60068, Part 2-6		2 g	
Shock resistance acc. to IEC 60068, Part 2-27		Half-sine 15 g/11 ms	
Power consumption			
• From auxiliary circuit L+/M (U1)	mA	Approx. 20	
• From auxiliary circuit A1/A2 (U2)		--	
Rated operational current I_e for power bus	A	25	
Rated operational voltage U_e	V	400 (50/60 Hz)	
Approval DIN VDE 0106, Part 101	V	Up to 500	
CSA and UL approval	V	Up to 600	
Conductor cross-sections			
Incoming power supply	mm ²	Max. 6 x 4	
Degree of protection		IP65	
Touch protection		Finger-safe	
Pollution degree		3, IEC 60664 (IEC 61131)	
Rated impulse withstand voltage U_{imp}	kV	6	
Rated insulation voltage U_i	V	400	
Rated operational current I_e for starters			
• AC-1/2/3 at 40 °C			
- At 400 V	A	16	25
- At 500 V	A	16	25
Rated short-circuit breaking capacity	kA	50 at 400 V	
Type of coordination acc. to IEC 60947-4-1		2	
Protective separation between main and auxiliary circuits	V	400, according to DIN VDE 0106, Part 101	
Operating times for 0.85 ... 1.1 x U_e			
• Closing delay	ms	--	25 ... 100
• Opening delay	ms	--	7 ... 10
Device functions			
• Group diagnostics		Yes, parameterizable	
Device indications			
• Group fault		SF LED (red)	

ET 200pro motor starter

Safety modules **IE3/IE4 ready**

Selection and ordering data

Version	SD	Article No.	Price per PU	PU (UNIT, SET, M)	PS*
---------	----	-------------	--------------	-------------------	-----

Safety modules local



3RK1304-0HS00-7AA0

Safety local isolator module¹⁾²⁾

Rated operational current 16 A

5

3RK1304-0HS00-7AA0

1

1 unit



3RK1304-0HS00-8AA0

400 V disconnecting modules³⁾⁴⁾

Rated operational current 25 A

2

3RK1304-0HS00-8AA0

1

1 unit

- 1) The Safety local isolator module only functions when used together with the 400 V disconnecting module.
- 2) Only in combination with the special backplane bus module for the Safety local isolator module (see "Accessories for ET 200pro motor starters", page 6/39).
- 3) The 400 V disconnecting module functions only when used together with the Safety local isolator module or with the F-Switch.
- 4) The 400 V disconnecting module functions only when used together with the backplane bus module and the wide module rack. The backplane bus module and the wide module rack must be ordered separately (see "Accessories for ET 200pro motor starters", page 6/39).

ET 200pro motor starter

Safety modules PROFIsafe **IE3/IE4 ready**

Overview

Safety Solution PROFIsafe

With the Safety PROFIsafe modules

- F-Switch and
 - 400 V disconnecting module
- with an appropriate connection, safety levels SIL 3 (according to IEC 62061) and PL e (according to ISO 13849-1) can be reached.

F-Switch PROFIsafe

Fail-safe digital inputs/outputs in degrees of protection IP65 to IP67 for near-machine, cabinet-free use.

Fail-safe digital inputs

- For the fail-safe reading in of sensor information (one-/two-channel)
- Including integrated discrepancy evaluation for 2v2 signals
- Internal sensor supplies (incl. testing) available

Fail-safe digital outputs

- Three fail-safe PP-switching outputs for safe switching of the backplane busbars

The F-Switch is certified up to SIL 3/PL e and has detailed diagnostics.

It supports PROFIsafe in PROFIBUS configurations as well as in PROFINET configurations.

Functionality

The PROFIsafe F-Switch is a fail-safe solid-state module for PROFIsafe safety applications. It has two fail-safe inputs and outputs for safe switching of the 24 V supply over backplane busbars. In combination with the 400 V disconnecting module, fail-safe disconnection of ET 200pro motor starters is possible in PROFIsafe applications up to SIL 3/PL e.

400 V disconnecting module

See "Safety modules local", Overview, page 6/31 and Technical specifications, page 6/32.

Selection and ordering data

Version	SD	Article No.	Price per PU	PU (UNIT, SET, M)	PS*
Safety modules PROFIsafe					
400 V disconnecting modules¹⁾²⁾					
Rated operational current 25 A	2	3RK1304-0HS00-8AA0		1	1 unit
F-Switch PROFIsafe					
24 V DC, including bus module	1	6ES7148-4FS00-0AB0		1	1 unit
<u>Note:</u> Connection module must be ordered separately					
Connection modules for F-Switch					
24 V DC	1	6ES7194-4DA00-0AA0		1	1 unit



3RK1304-0HS00-8AA0



6ES7148-4FS00-0AB0

¹⁾ The 400 V disconnecting module functions only when used together with the Safety local isolator module or with the F-Switch.
²⁾ The 400 V disconnecting module functions only when used together with the backplane bus module and the wide module rack. The backplane bus module and the wide module rack must be ordered separately (see "Accessories for ET 200pro motor starters", page 6/39).

Overview

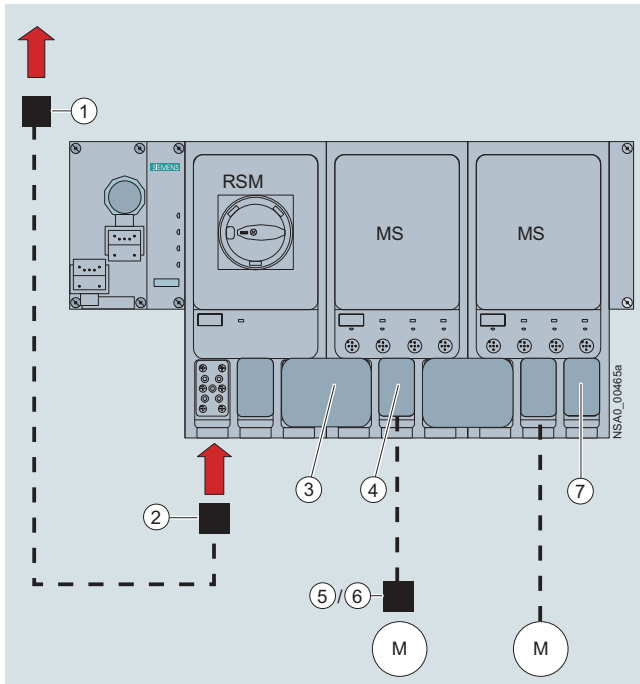

Basic design of an ET 200pro version with (from the left) connection module for IM, interface module for communication (IM), RSM isolator module, two ET 200pro motor starters (MS), and connections for energy

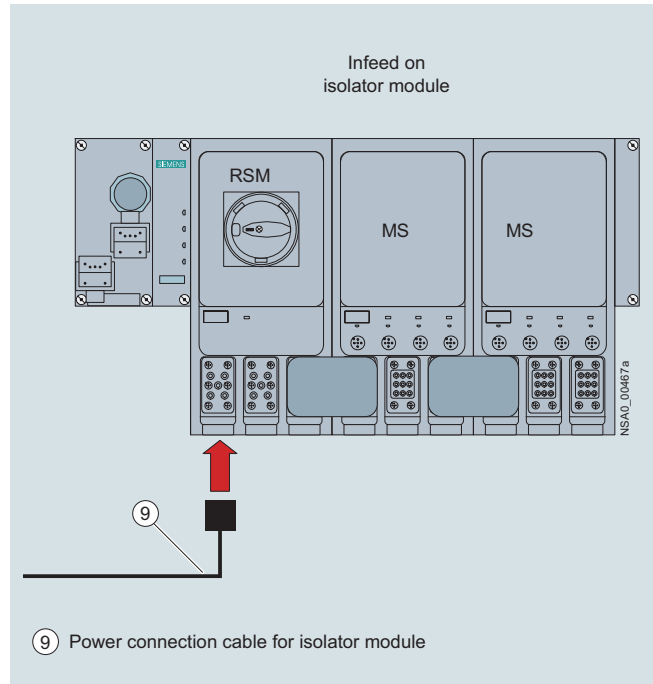

Infeed on the RSM isolator module

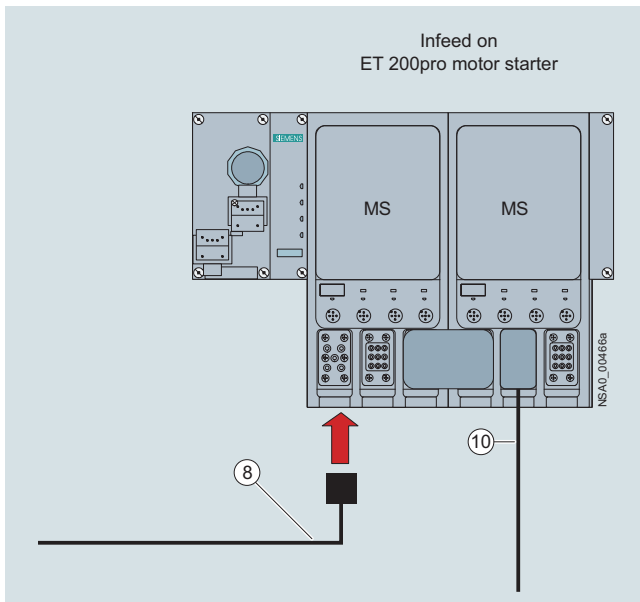

Infeed on the ET 200pro motor starter

Legend:

- ① Power feeder plug (see page 6/37)
- ② Power connection plug (see page 6/37)
- ③ Power jumper plug (see page 6/37)
- ④ Motor connection plug (see page 6/37)
- ⑤ Motor plug (see page 6/37)
- ⑥ Motor plug with EMC suppressor circuit (see page 6/37)
- ⑦ Power loop-through plug (see page 6/37)
- ⑧ Power connection cable (see page 6/37)
- ⑨ Power connection cable for isolator module (see page 6/37)
- ⑩ Motor cable (see page 6/38)

ET 200pro motor starter

Accessories

Power bus

The power supply to the field devices (ET 200pro motor starters, M200D motor starters) is provided via the power bus, in which the power T terminal connectors or power double-T terminal connectors are connected by power bus cables.

Feeders

From the terminal connectors, spur lines with Han Q4/2 plugs lead to the field devices, from which the motors are supplied with power via motor connection cables.

Interruption-free thanks to power terminal connectors

In finger-safe connection technology the power T terminal connectors and power double-T terminal connectors connect the components of a feeder to the power bus. They ensure interruption-free operation, i.e. the power bus is not interrupted when the components are unplugged.

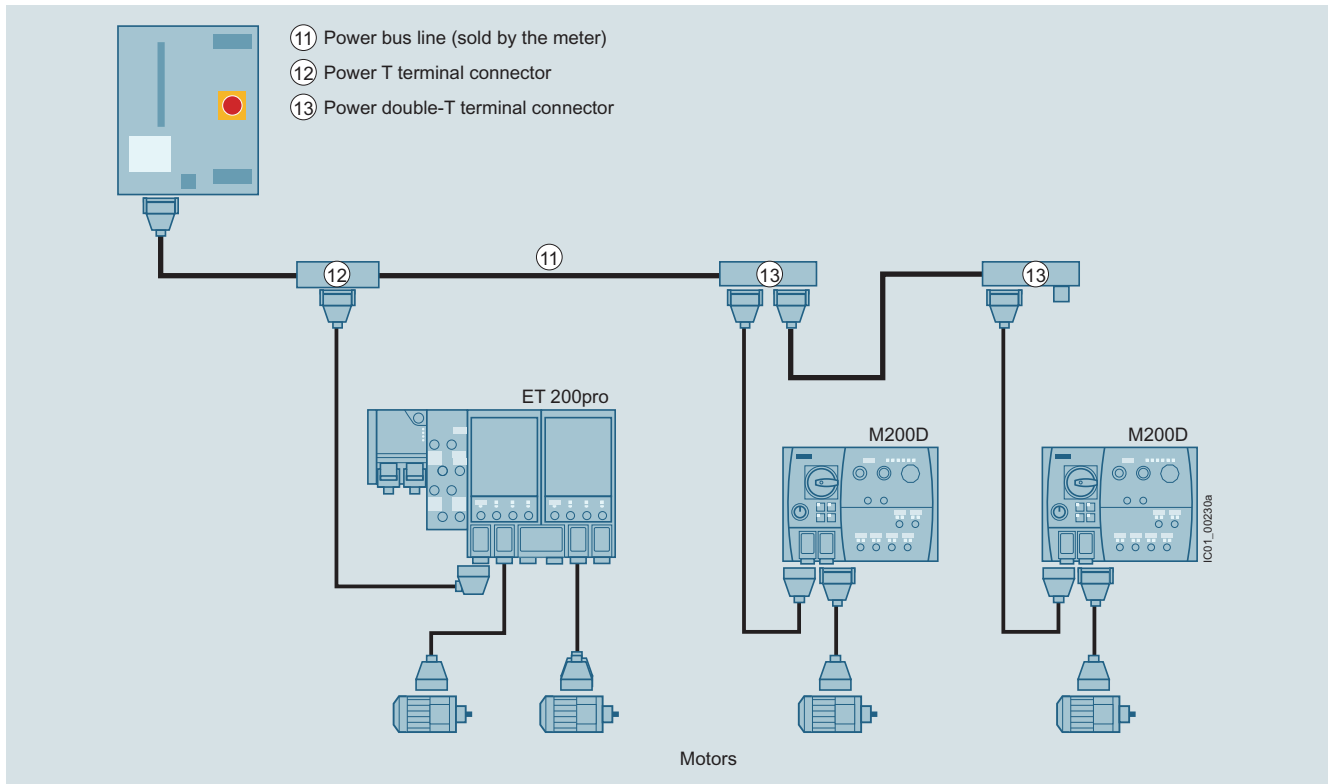

Power supply to the motors via the power bus with power T and double-T terminal connectors linked by power bus cables, spur lines to the field devices (motor starters), and power loop-through connections to the motors via motor connection cables

Motor control via PROFIBUS

The interface modules (IM) for PROFIBUS can be combined with three different connection modules for connecting PROFIBUS DP and the power supply:

- Direct connection with cable gland
- ECOFAST connection with hybrid fieldbus cables (with two copper cores for data transmission with PROFIBUS DP, and four copper cores for the power supply), and ECOFAST plugs (HanBrid)¹⁾
- M12, 7/8" connection
 - with M12 connecting cable and M12 plugs for data transmission with PROFIBUS DP
 - with 7/8" connecting cable and 7/8" plugs for the power supply²⁾

For connection modules with the relevant accessories, see ["Accessories for ET 200pro interface modules"](#) in Catalog ST 70 or the Industry Mall.

¹⁾ Hybrid fieldbus connections with HanBrid sockets designed as cabinet bushings transmit data and energy from the control cabinet (IP20) to the field (IP65). They are the interface for jointly routing PROFIBUS DP and the auxiliary voltages into the hybrid fieldbus cable (see page 6/66).



Motor control via PROFINET

For connection modules with the relevant accessories, see ["Accessories for ET 200pro interface modules"](#) in Catalog ST 70 or the Industry Mall.

²⁾ On the control cabinet bushings with two M12 sockets for the PROFIBUS M12 connecting cables (see page 6/66), the 24 V supply of the motor starters is implemented via separate 7/8" connecting cables.

Selection and ordering data

Version	SD	Article No.	Price per PU	PU (UNIT, SET, M)	PS*
Incoming power supply					
① Power feeder plugs					
Connector set for incoming power supply, e.g. for connecting to T terminal connectors, comprising a coupling enclosure, straight outgoing feeder (with bracket), pin insert for HAN Q4/2, incl. gland					
• 5 male contacts, 2.5 mm ²	5	3RK1911-2BS60		1	1 unit
• 5 male contacts, 4 mm ²	5	3RK1911-2BS20		1	1 unit
• 5 male contacts, 6 mm ²	5	3RK1911-2BS40		1	1 unit
② Power connection plugs					
Connector set for incoming power supply for connection to ET 200pro motor starters/ET 200pro isolator modules, comprising a cable-end connector hood, angular outgoing feeder, female insert for HAN Q4/2, incl. gland					
• 5 female contacts, 2.5 mm ²	5	3RK1911-2BE50		1	1 unit
• 5 female contacts, 4 mm ²	5	3RK1911-2BE10		1	1 unit
• 5 female contacts, 6 mm ²	5	3RK1911-2BE30		1	1 unit
⑧ Power connection cables, assembled at one end					
Power connection cable for ET 200pro motor starters, open at one end, for HAN Q4/2, angular, 4 x 4 mm ²					
• Length 1.5 m	5	3RK1911-0DB13		1	1 unit
• Length 5.0 m	5	3RK1911-0DB33		1	1 unit
⑨ Power connection cables for isolator module, assembled at one end					
Power connection cable for ET 200pro isolator modules, open at one end, for HAN Q4/2, angular, insert turned at isolator module end, 4 x 4 mm ²					
• Length 1.5 m	30	3RK1911-0DF13		1	1 unit
• Length 5.0 m	30	3RK1911-0DF33		1	1 unit
Power loop-through on the field device					
③ Power jumper plugs					
	2	3RK1922-2BQ00		1	1 unit
⑦ Power loop-through plugs					
Connector set for power loop-through for connection to ET 200pro motor starters/ET 200pro isolator modules, comprising a cable-end connector hood, angular outgoing feeder, pin insert for HAN Q4/2, incl. gland					
• 4 male contacts, 2.5 mm ²	5	3RK1911-2BF50		1	1 unit
• 4 male contacts, 4 mm ²	5	3RK1911-2BF10		1	1 unit
Motor cables					
④ Motor connection plugs					
Connector set for motor cable for connection to ET 200pro motor starters, comprising a cable-end connector hood, angular outgoing feeder, pin insert for HAN Q8/0, incl. gland					
• 8 male contacts, 1.5 mm ²	5	3RK1902-0CE00		1	1 unit
• 6 male contacts, 2.5 mm ²	5	3RK1902-0CC00		1	1 unit
⑤ Motor plugs					
Connector set for motor cable for connection to motors, comprising a cable-end connector hood, straight outgoing feeder, female insert for HAN 10e, incl. star jumper, incl. gland					
• 7 female contacts, 1.5 mm ²	30	3RK1911-2BM21		1	1 set
• 7 female contacts, 2.5 mm ²	30	3RK1911-2BM22		1	1 set
⑥ Motor plugs with EMC suppressor circuit					
Connector set for motor cable for connection to motors, comprising a cable-end connector hood, straight outgoing feeder, female insert for HAN 10e with EMC suppressor circuit, incl. star jumper, incl. gland					
• 7 female contacts, 1.5 mm ²	30	3RK1911-2BL21		1	1 set
• 7 female contacts, 2.5 mm ²	30	3RK1911-2BL22		1	1 set

Version	SD	Article No.	Price per PU	PU (UNIT, SET, M)	PS*
Motor cables (continued)					
⑩ Motor cables, assembled at one end					
Open at one end, HAN Q8, angular, length 5 m					
• For motor without brake, for ET 200pro, 4 x 1.5 mm ²	15	3RK1911-0EB31		1	1 unit
• For motor with brake for ET 200pro, 6 x 1.5 mm ²	30	3RK1911-0ED31		1	1 unit
• For motor without brake, with thermistor, for ET 200pro, 6 x 1.5 mm ²	30	3RK1911-0EF31		1	1 unit
• For motor with brake and thermistor for ET 200pro, 8 x 1.5 mm ²	30	3RK1911-0EG31		1	1 unit
Power bus					
⑫ Power T terminal connectors					
For 400 V AC, for connection of feeders (e.g. motor starters) by means of standard round cable at any point of the power bus, by insulation displacement connection, used with preassembled bus segments					
• 2.5 mm ² /4 mm ²	5	3RK1911-2BF01		1	1 unit
• 4 mm ² /6 mm ²	5	3RK1911-2BF02		1	1 unit
⑬ Power double-T terminal connectors					
For 400 V AC, for connection of feeders (e.g. motor starters) by means of standard round cable at any point of the power bus, by insulation displacement connection, used with preassembled bus segments, connection of two motor starters possible					
• 4 mm ² /6 mm ²	5	3RK1911-2BG02		1	1 unit
Sealing set (comprising 2 seals)					
For power T/power double-T terminal connectors					
• For power cables with Ø 10 ... 13 mm	5	3RK1911-5BA00		1	1 unit
• For power cables with Ø 13 ... 16 mm	5	3RK1911-5BA10		1	1 unit
• For power cables with Ø 16 ... 19 mm	5	3RK1911-5BA20		1	1 unit
• For power cables with Ø 19 ... 22 mm	X	3RK1911-5BA30		1	1 unit
• Blanking plugs	5	3RK1911-5BA50		1	1 unit
Further accessories for power connections					
Crimping tool					
	15	3RK1902-0CW00		1	1 unit
3RK1902-0CW00					
Dismantling tools					
• For male and female contacts for 9-pole HAN Q4/2 inserts					
	15	3RK1902-0AB00		1	1 unit
• For male and female contacts for 9-pole HAN Q8 inserts					
	5	3RK1902-0AJ00		1	1 unit
Sealing caps					
For 9-pole power sockets					
• 1 unit per pack	5	3RK1902-0CK00		1	1 unit
• 10 units per pack	5	3RK1902-0CJ00		1	10 units
					
3RK1902-0CK00					

ET 200pro motor starter

Accessories

Version	SD	Article No.	Price per PU	PU (UNIT, SET, M)	PS*
Further accessories					
Module racks, wide¹⁾					
• Length 500 mm	1	6ES7194-4GB00-0AA0		1	1 unit
• Length 1 000 mm	1	6ES7194-4GB60-0AA0		1	1 unit
• Length 2 000 mm	1	6ES7194-4GB20-0AA0		1	1 unit
Module racks, wide, compact¹⁾					
• Length 500 mm	1	6ES7194-4GD00-0AA0		1	1 unit
• Length 1 000 mm	1	6ES7194-4GD10-0AA0		1	1 unit
• Length 2 000 mm	1	6ES7194-4GD20-0AA0		1	1 unit
Backplane bus modules 110 mm²⁾					
Backplane bus module for Safety local isolator modules	2	3RK1922-2BA01		1	1 unit
Handheld devices For ET 200pro motor starters (or for ET 200S High Feature and M200D motor starters) for local operation. <u>Notes:</u> • The motor-starter-specific serial interface cables must be ordered separately. • The RS 232 interface cable 3RK1922-2BP00 is used for the MS ET 200pro.	5	3RK1922-3BA00		1	1 unit
RS 232 interface cable Serial data connection between ET 200pro (or M200D) motor starters and the RS 232 interface of a PC/PG/laptop (with the Motor Starter ES software) or the handheld device 3RK1922-3BA00.	5	3RK1922-2BP00		1	1 unit
USB interface cable, 2.5 m Serial data connection between ET 200pro (or M200D) motor starters and the USB interface of a PC/PG/laptop (with the Motor Starter ES software).	3	6SL3555-0PA00-2AA0		1	1 unit
M12 sealing caps For sealing unused M12 input or output sockets (one set contains ten sealing caps)	▶	3RK1901-1KA00		100	10 units
Motor suppression module RC element for installation in motor terminal box					
• Angular design	15	3RK1911-6EA00		1	1 unit
• Round design	15	3RK1911-6EB00		1	1 unit



3RK1922-3BA00



3RK1901-1KA00



3RK1911-6EA00



3RK1911-6EB00

¹⁾ The wide module rack can accommodate all ET 200pro motor starters and any optional modules (isolator module, Safety local isolator module and 400 V disconnecting module).
²⁾ The backplane bus module is a prerequisite for operation of the ET 200pro motor starter and the optional module.

For more connection technology products, see <https://support.industry.siemens.com/cs/ww/en/view/65355810..>

Overview

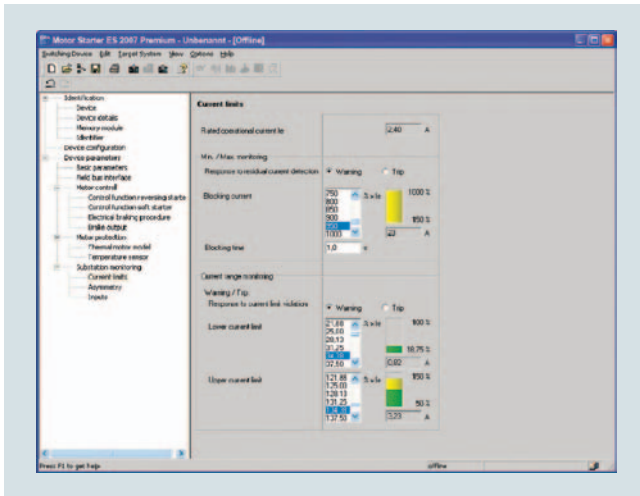

Motor Starter ES for parameterization, monitoring, diagnostics and testing of motor starters

More information

Industry Mall, see www.siemens.com/product?3ZS1

Technical specifications and system requirements, see <https://support.industry.siemens.com/cs/ww/en/ps/16713/td>

Motor Starter ES is used for the startup, parameterization, diagnostics, documentation and preventive maintenance of SIMATIC ET 200S, ET 200pro, ECOFAST and M200D motor starters.

The software program is available in three versions which differ in their user-friendliness, scope of functions and price.

SIRIUS M200D motor starters

General data

Overview



SIRIUS M200D AS-i Basic motor starter with manual local operation

The intelligent and highly flexible SIRIUS M200D motor starters for distributed installation start, monitor and protect motors and loads up to 7.5 HP.

The M200D motor starters are available in four versions:

M200D AS-i Basic	M200D AS-i Standard	M200D PROFIBUS	M200D PROFINET
Motor control with AS-i communication		PROFIBUS	PROFINET
Mechanical or electronic switching	✓	✓	✓
Electronic switching with soft starter functionality	--	✓	✓

✓ Function available

-- Function not available

Article No. scheme

Product versions		Article number																
Motor starters		3	R	K	1	3	5	-	6	K	S	4	1	-	3	A	A	0
Type	AS-i Basic AS-i Standard PROFIBUS/PROFINET	1														A		
		2														A		
		9														D		
Setting range for rated operational current I _A	0.15 ... 2 A 1.5 ... 9 A 1.5 ... 12 A									K N L								
Starter version	Electromechanical starters Electronic starters											4					with integrated contactor with thyristors	
Product function	Direct-on-line starters Reversing starters Direct-on-line starters Reversing starters														0 1 2 3		with manual local operation with manual local operation	
Brake actuation	None 230/400 V AC 180 V DC															0 3 5		
Example		3	R	K	1	3	5	-	6	K	S	4	1	-	3	A	A	0

Note:

The Article No. scheme shows an overview of product versions for better understanding of the logic behind the article numbers.

More information

Homepage, see www.siemens.com/motorstarter
 Industry Mall, see www.siemens.com/product?M200D
 TIA Selection Tool Cloud (TST Cloud), see https://www.siemens.com/tstcloud/?node=MS_M200D

Basic functionality

The versions of the M200D motor starter are equipped with the following properties and functions:

- Available as direct-on-line and reversing starters in a rugged design
- Electromechanical or electronic switching version
- Low variance – only two device versions up to 7.5 HP thanks to wide range setting
- All versions have the same enclosure size.
- Degree of protection IP65
- Quick and fail-safe wiring of system and motor cables using ISO 23570 plug-in connector technology (Q4/2 and Q8/0)
- Robust and widely used M12 connection method for digital inputs and outputs
- Integrated feeder connector monitoring
- Full motor protection through overload protection and a temperature sensor (PTC, TC)
- Short-circuit and overload protection integrated
- Integrated repair switch lockable with three locks (multi-level service)
- Uniform wiring to the SINAMICS G110D, SINAMICS G110M and SINAMICS G120D frequency inverters and to the ET 200pro distributed I/O system
- Extensive diagnostics concept using LEDs
- Optional integrated manual local control with key-operated switch (ordering option)
- Optionally available brake actuation with voltages from 180 V DC (no rectifier needed in motor) or 230/400 V AC (ordering options)

SIRIUS M200D motor starters

General data

Benefits

M200D motor starters provide the following advantages for customers:

- High plant availability through plug-in capability of the main circuit, communication and I/Os – relevant for installing and replacing devices
- Cabinet-free construction and near-motor installation thanks to the high degree of protection IP65
- The motor starters record the actual current flow for the parameterizable electronic motor overload protection. Reliable messages concerning the overshooting or undershooting of setpoint values ensure comprehensive motor protection. All motor protection functions can be defined by simple parameterization
- Low stock levels and low order costs thanks to a wide setting range for the electronic motor protection of 1:10 (only two device versions up to 7.5 HP)
- The integrated wide range for the current enables a single device to cover numerous standard motors of different sizes.
- Comprehensive offering of accessories, including ready-assembled cables
- The M200D motor starters can be installed with a few manual steps. The integrated plug-in technology enables far lower wiring outlay: Preassembled cables can be plugged directly onto the motor starter module.
- Easy and user-friendly installation because all versions have the same enclosure dimensions.
- Fast and user-friendly commissioning using optional manual local operation
- Increase of process speed through integrated functions such as "Quick Stop" and "Disable Quick Stop", e.g. at points and crossings
- Optional manual local control with momentary-contact and latching operation for easier startup and easier servicing

Application

The high degree of protection IP65 makes the M200D motor starters suitable in particular for use on extensive conveying systems such as are found in mail sorting centers, airports, automotive factories and the packing industry.

For simple drive tasks, particularly in conveyor applications, the new SINAMICS G110D frequency inverter series with a performance range from 0.75 kW to 7.5 kW and degree of protection IP65 is the ideal partner for the M200D motor starters.

SINAMICS G110D converters allow for stepless speed control of three-phase asynchronous motors and comply with the requirements for materials handling applications with frequency control.

For simple drive tasks in conveyor applications in which a frequency inverter integrated into the motor is required, the SINAMICS G110M frequency inverter with a performance range from 0.37 kW to 4 kW and degree of protection IP65/66 is the ideal partner. The SINAMICS G110M is available individually as a frequency converter for self-assembly and pre-mounted on SIMOGEAR geared motors, and with its conveyor-specific functions it satisfies the requirements of conveyor technology applications.

Use of SIRIUS M200D motor starters in conjunction with IE3/IE4 motors

Note:

For the use of SIRIUS M200D motor starters in conjunction with highly energy-efficient IE3/IE4 motors, please observe the information on dimensioning and configuring, [see Application Manual..](#)

Overview

For motor control using AS-Interface there are the following M200D motor starter versions: SIRIUS M200D AS-i Basic and SIRIUS M200D AS-i Standard (basic functionality, [see page 16/41 "SIRIUS M200D Motor Starters" → "General data" → "Overview"](#)).

SIRIUS M200D AS-i Basic

Functionality

- Easy and fast on-site startup through parameterization of local setting knobs (DIP switches) and rotary coding switches for adjusting the rated operational current. The rotary coding switch has an OFF position for deactivating the overload protection with the help of the thermal motor model when using a temperature sensor.

Communications

- AS-i communication with A/B addressing according to Spec V2.1
- The AS-i bus is connected cost-effectively using an M12 connection on the device. Of the four digital inputs, two are contained in the process image and can therefore be used in the PLC program. The other two inputs are locally effective and permanently assigned with functions.
- The LEDs can provide comprehensive diagnostics of the device on the spot. In addition to diagnostics using the PAE process image, the device can create up to 15 different diagnostic signals per slave. The message with the highest priority can be read out through the AS-i communication. This is yet another new development which distinguishes the M200D AS-i Basic motor starter from the rest of the market and adds innovative technology, maximum availability and transparency to the system.

SIRIUS M200D AS-i Standard

The intelligent and highly flexible M200D AS-i Standard motor starter in A/B technology starts and protects motors and loads up to 5.5 kW. They are available in direct-on-line or reversing starter versions, in a mechanical version and also an electronic version (the latter with soft start function).

The M200D AS-i Standard motor starter is the most functional member of the SIRIUS motor starter family in the high degree of protection IP65 for AS-i communication. Consistency with other products of the SIRIUS M200D motor starter range and with the frequency converter and ET 200pro I/O system is assured.

Functionality

- AS-i communication with A/B addressing according to Spec 3.0
- Electronic version also with soft start function
- AS-i slave profile 7AE/7A5 with process image 6E/4A
- Full TIA integration: All digital inputs and outputs exist in the cyclic process image and are visible through AS-i, providing maximum flexibility and best adaptability to the application.
- Additionally expanded diagnostics using data record through AS-i bus
- Complete plant monitoring using statistics data record and current value monitoring by means of data records
- Parameterization through AS-i bus with the help of data records or an expanded process image from the user program
- Control of the motor starter using a command data record from the user program
- Flexible assignment of the digital inputs and outputs with all available assignable input actions
- Parameterization using Motor Starter ES at the local interface (ordering option for startup software)
- Diagnostics with the help of Motor Starter ES (ordering option for startup software)

Mounting and installation

The M200D motor starters can be installed with a few manual steps. The integrated plug-in technology enables far lower wiring outlay. Connecting cables can be plugged directly onto the motor starter module. Swapping of the connecting wires and malfunctions within the plant are prevented by preassembled cables. The AS-i bus is connected cost-effectively using an M12 connection on the device. All versions have identical enclosure dimensions for easier system design and conversion.

Parameterization and configuration

The particularly robust M200D AS-i Standard motor starter is characterized by numerous functions which can be flexibly parameterized. It enables highly flexible parameterization through the AS-i bus using data records from the user program as well as user-friendly local parameterization using the Motor Starter ES startup software through the local point-to-point interface.

Functions can be flexibly assigned to the digital inputs and outputs, adapting them to all possible conveyor applications. All motor protection functions, limit values and reactions can be defined by parameterization. The AS-i Standard is unique. In its 6E/4A process image the motor starter sends all four digital inputs and the digital output via the process image to the PLC in cyclic mode. System configuration and system documentation are facilitated not least by a number of CAX data.

Operation

The new generation of motor starters is characterized by its advanced functionality, maximum flexibility and extremely high degree of automation.

All digital inputs and outputs exist in the cyclic process image. All limit values for monitoring functions and their reactions are parameterizable and therefore adaptable to the application. The motor starters record the actual current flow. Evaluating the current of the parameterizable solid-state overload protection increases the availability of the drives, as do reliable messages concerning the overshooting or undershooting of setpoint values.

Diagnostics and maintenance

The M200D sets new standards for diagnostics. In addition to diagnostics using the PAE process image and diagnostics by "parameter echo" (up to 15 different diagnostic signals per slave can be read out via AS-i communication), the possibility of reading out diagnostic data records is unique on the market.

The AS-i Standard is recommended in particular for expansive and highly automated system components because the possibility of monitoring devices and systems with data records (statistical data, measured values and device diagnostics) provides an in-depth view of the plant from the control room, guaranteeing the monitoring process and increasing plant availability.

Preventive maintenance can be carried out with the integrated maintenance timer and plant downtimes prevented as a result in advance.

Local control of a drive is possible using the ordering option with integrated manual operation. This is yet another new development which distinguishes the M200D AS-i Standard motor starter from the rest of the market and adds innovative technology, maximum availability and transparency to the plant.

SIRIUS M200D
AS-i Basic
SIRIUS M200D
AS-i Standard
Device functions (firmware features)
Slave on the bus

Fieldbus	✓ AS-i	
Slave type	✓ A/B acc. to Spec 2.1	✓ A/B acc. to Spec 3.0
Profile	✓ 7.A.E	✓ 7.A.E & 7.A.5
Number of assigned AS-i addresses on the bus	✓ 1	✓ 2
Number of stations per AS-i master	✓ Max. 62 devices	✓ Max. 31 devices
AS-i master profile	✓ M3 and higher	✓ M4 and higher

Parameter assignment

DIP switches	✓	--
Potentiometer for rated operational current	✓	--
Motor Starter ES	--	✓
Data records through AS-i	--	✓

Diagnostics

Diagnostics through parameter channel	✓	
Acyclic through data records	--	✓
Expanded process image PAE 4 bytes	--	✓

Process image

Process image	✓ 4E/3A	✓ 6E/4A
---------------	---------	---------

Data channels

Local optical interface (manual local)	✓	
AS-i bus	✓	
Motor Starter ES through local interface	--	✓
Motor Starter ES through bus	--	

Data records¹⁾ (acyclic)

Parameter assignment	--	✓
Diagnostics	--	✓
Measured values	--	✓
Statistics	--	✓
Commands	--	✓

Inputs

Number	✓ 4	
• Of these in the process image	✓ 2 through AS-i	✓ 4 through AS-i
Input action	✓ For permanently assigned functions, see manual	✓ Parameterizable: flexible
Quick stop	✓ Permanent function: latching, edge-triggered	✓ Parameterizable function: latching (edge-triggered), non-latching (level-triggered)

Outputs

Number	✓ 1	
Output action	✓ Permanent function: assigned with group fault	✓ Parameterizable: For function, see manual

Brake output

180 V DC / 230/400 V AC / none	✓	
--------------------------------	---	--

Motor protection

Overload protection	✓ Electronic, wide range 1:10	
Short-circuit protection	✓	
Full motor protection	✓	
Temperature sensor	✓ Parameterizable using DIP switches: PTC or Thermoclick or deactivated	✓ Parameterizable via Motor Starter ES, data record: PTC or Thermoclick or deactivated

✓ Function available

-- Function not available

¹⁾ The data records are a reduced selection compared with PROFIBUS/PROFINET.

SIRIUS M200D motor starters for AS-Interface

General data



**SIRIUS M200D
AS-i Basic**

**SIRIUS M200D
AS-i Standard**

Device functions (firmware features) (continued)

Device function	SIRIUS M200D AS-i Basic	SIRIUS M200D AS-i Standard
Repair switch	✓	
Current limit monitoring bottom	--	✓ Parameterizable
Current limit monitoring top	--	✓ Parameterizable
Zero current detection	✓ Permanent function: disconnection, less than 18.75% of the rated operational current I_e	✓ Parameterizable
Blocking current	✓ Permanent function: starting up of the motor: Tripping limit up to 800% of the rated operational current I_e for 10 s Active operation: Threshold for tripping "blocking current" up to 400% of the rated operational current I_e	✓ Parameterizable
Asymmetry	✓ Permanent function: up to 30% of the rated operational current I_e (only mechanical MS)	✓ Parameterizable
Load type	✓ Permanent function: Three-phase	✓ Parameterizable: single-phase and three-phase
Shutdown class	✓ Parameterizable using DIP switches: CLASS 10/deactivated	Parameterizable via Motor Starter ES, data record: CLASS 5, 10, 15, 20
Protection against voltage failure	✓	✓ Parameterizable: activated/deactivated
Soft starter control function		
Soft start function	--	✓ Only solid-state version
Bypass function	--	✓ Only solid-state version

- ✓ Function available
- Function not available

Application

The M200D AS-i standard is particularly suitable for highly automated applications in conveyor systems requiring devices and systems to be monitored to prevent or limit plant downtime. The option of planning the functions of the motor starter or its interfaces also creates the prerequisite for fine-adjustment to the function of the motor starter in the application and hence provides for extreme flexibility.

Use of M200D motor starters in conjunction with IE3/IE4 motors

Note:

For the use of SIRIUS M200D motor starters in conjunction with highly energy-efficient IE3/IE4 motors, please observe the information on dimensioning and configuring,; see [Application Manual](#).

Technical specifications

More information

- Manuals for SIRIUS M200D:
- AS-i Basic, see <https://support.industry.siemens.com/cs/ww/en/view/35016496>
 - AS-i Standard, see <https://support.industry.siemens.com/cs/ww/en/view/38722160>
- FAQs, see <https://support.industry.siemens.com/cs/ww/en/ps/16324/faq>

Notes on security:

In order to protect plants, systems, machines and networks against cyber threats, it is necessary to implement – and continuously maintain – a holistic, state-of-the-art industrial security concept. Siemens products and solutions represent only one component of such a concept.

For more information on the subject of Industrial Security, see www.siemens.com/industrialsecurity.

General data

Type	M200D motor starters				
	AS-i Basic electromechanical switching DSte/RSSte	AS-i Basic electronic switching sDSte/sRSSte	AS-i Standard electromechanical switching DSte/RSSte	AS-i Standard electronic switching sDSSSte/sRSSte	
Technology designation¹⁾					
Mechanics and environment					
Mounting dimensions (W x H x D)	mm	294 x 215 x 159			
Permissible ambient temperature					
• During operation	°C	-25 ... +55			
• During storage	°C	-40 ... +70			
Weight	g	2 880/3 130	3 220/3 420	2 880/3 130	3 220/3 420
Permissible mounting position		Vertical, horizontal, lying			
Vibration resistance acc. to IEC 60068 Part 2-6	g	2			
Shock resistance					
• Acc. to IEC 60068 Part 2-27	g/ms	12/11 half-sine			
• Without influencing the contact position	g/ms	9.8/5 or 5.9/10			
Degree of protection acc. to IEC 529		IP65			
Installation altitude					
• Up to 1 000 m		No derating			
• Up to 2 000 m		1% per 100 m			
Cooling		Convection			
Protection class IEC 536 (VDE 0106-1)		1			
Electrical specifications					
Control circuit					
Operating voltage U_{AS-i}	V DC	26.5 ... 31.6			
Supply voltage U_{aux}	V DC	20.4 ... 28.8			
Power consumption from AS-i (incl. 200 mA sensor supply)	mA	< 300			
Current consumption from U_{aux} (without digital output)					
• Max.	mA	155	15 (direct-on-line)/ 175 (reversing)	155	15 (direct-on-line)/ 175 (reversing)
• Typ.	mA	75	10 (direct-on-line)/ 75 (reversing)	75	10 (direct-on-line)/ 75 (reversing)
Main circuit					
Maximum power of three-phase motors at 400 V AC	kW	5.5	4	5.5	5.5
Rated operational voltage U_e					
• Approval acc. to EN 60947-1	V AC	400 (50/60 Hz)			
• Approval acc. to UL and CSA	V AC	600 (50/60 Hz)			
• Rated operational current range	A	0.15 ... 2/1.5 ... 12	--	0.15 ... 2/1.5 ... 12	--
• Rated operational current range for soft starting	A	--			0.15 ... 2/1.5 ... 12
• Rated operational current range for direct-on-line starting	A	--	0.15 ... 2/1.5 ... 9	--	0.15 ... 2/1.5 ... 9
Rated operational current for starters I_e at 400 V AC					
• 400 V at AC-1/2/3	A	12	--	12	--
• 500 V at AC-1/2/3	A	9	--	9	--
• 400 V at AC-4	A	4	--	4	--
• 400 V at AC-53a	A	--	9	--	12 for soft starting 9 for direct-on-line starting
Mechanical endurance of contactor	Operating cycles	30 million	--	30 million	--
Trip class		CLASS 10		CLASS 5, 10, 15, 20	
Type of coordination acc. to IEC 60947-4-1		1 (2 for device version 2A)	1	1 (2 for device version 2A)	1
Permissible switching frequency		see manual		see manual	
Rated ultimate short-circuit breaking capacity I_q					
• At 400 V AC	kA	50			
• At 500 V AC	kA	50 ²⁾	20 ²⁾	50	20 ²⁾
Short-circuit protection					
• At $I_{emax} = 2$ A		Integrated, 2 x 13 $I_e = 26$ A			
• At $I_{emax} = 9/12$ A		Integrated, 2 x 13 $I_e = 208$ A			
Brake actuation (option)					
Operational voltage	V	230/400 AC or 180 DC			
Uninterrupted current	A	< 0.5 at 230/400 V AC < 0.8 at 180 V DC			
Short-circuit protection		Yes, 1 A melting fuse			

¹⁾ DS ... Direct-on-line starters
RS ... Reversing starters
DSS ... Direct-on-line soft starters
RSS ... Reversing soft starters
te Full motor protection (thermal + electronic)
s Electronic switching with semiconductor.

²⁾ Only systems with grounded neutral point permitted.

SIRIUS M200D motor starters for AS-Interface

Basic motor starter **IE3/IE4 ready**

Selection and ordering data



M200D AS-i Basic without manual local operation



M200D AS-i Basic with manual local operation

Version	SD	Article No.	Price per PU	PU (UNIT, SET, M)	PS*
	d				

Electromechanical starters (with integrated contactor)

15	3RK1315-6□S41-□AA□	1	1 unit
----	---------------------------	---	--------

Rated operational current setting range/A

- 0.15 ... 2
- 1.5 ... 12

Direct-on-line starters/reversing starters

- Direct-on-line starters
- Reversing starters
- Direct-on-line starters with manual local operation
- Reversing starters with manual local operation

Brake actuation

- Without brake actuation
- Brake actuation (230/400 V AC)
- Brake actuation (180 V DC)

Additional price
None
✓
None
✓
✓
✓
None
✓
✓

Electronic starters (with thyristors)

15	3RK1315-6□S71-□AA□	1	1 unit
----	---------------------------	---	--------

Rated operational current setting range/A

- 0.15 ... 2
- 1.5 ... 9

Direct-on-line starters/reversing starters

- Direct-on-line starters
- Reversing starters
- Direct-on-line starters with manual local operation
- Reversing starters with manual local operation

Brake actuation

- Without brake actuation
- Brake actuation (230/400 V AC)
- Brake actuation (180 V DC)

Additional price
None
✓
None
✓
✓
✓
None
✓
✓

✓ = Additional price

SIRIUS M200D motor starters for AS-Interface

Standard motor starter **IE3/IE4 ready**

Selection and ordering data



M200D AS-i Standard without manual local operation



M200D AS-i Standard with manual local operation

Version	SD	Article No.	Price per PU	PU (UNIT, SET, M)	PS*
	d				

Electromechanical starters (with integrated contactor)

15		3RK1325-6□S41-□AA□		1	1 unit
----	--	---------------------------	--	---	--------

Rated operational current setting range/A

- 0.15 ... 2
- 1.5 ... 12

Direct-on-line starters/reversing starters

- Direct-on-line starters
- Reversing starters
- Direct-on-line starters with manual local operation
- Reversing starters with manual local operation

Brake actuation

- Without brake actuation
- Brake actuation (230/400 V AC)
- Brake actuation (180 V DC)

Additional price
None
✓
None
✓
✓
✓
None
✓
✓

Electronic starters (with thyristors)

15		3RK1325-6□S71-□AA□		1	1 unit
----	--	---------------------------	--	---	--------

Rated operational current setting range/A

- 0.15 ... 2
- 1.5 ... 12

Direct-on-line starters/reversing starters

- Direct-on-line starters
- Reversing starters
- Direct-on-line starters with manual local operation
- Reversing starters with manual local operation

Brake actuation

- Without brake actuation
- Brake actuation (230/400 V AC)
- Brake actuation (180 V DC)

Additional price
None
✓
None
✓
✓
✓
None
✓
✓

✓ = Additional price

SIRIUS M200D motor starters for PROFIBUS/PROFINET

General data

Overview

The intelligent, highly flexible M200D PROFIBUS/PROFINET motor starters are the most functional motor starters of the SIRIUS motor starter family in the high degree of protection IP65 for PROFIBUS/PROFINET communication.

They start and protect motors and loads up to 7.5 HP. Direct-on-line and reversing starter versions are available, in a mechanical version and also an electronic version (the latter with soft start function).

The particularly robust M200D PROFIBUS/PROFINET motor starters are characterized by numerous functions which can be flexibly parameterized. Their modular design comprises a motor starter module and a communication module.

The M200D PROFINET motor starters enable TIA-integrated parameterization through PROFINET from STEP 7 – in familiar, user-friendly manner with the look and feel of PROFIBUS.

Functionality

- For basic functionality, see page 16/41 “SIRIUS M200D Motor Starters” → “General data” → “Overview”
 - Electronic version also with soft start function
 - Robust and widely used M12 connection method for the digital inputs and outputs and the PROFIBUS/PROFINET bus connection
 - All four digital inputs and two digital outputs exist in the cyclic process image. This provides complete transparency of the process on the control level
 - Full TIA integration: All digital inputs and outputs exist in the cyclic process image and are visible through the bus, providing maximum flexibility and excellent adaptability to the application
 - Flexible assignment of the digital inputs and outputs with all available assignable input actions
 - Extensive diagnostics concept using LEDs and through the bus with the TIA-compatible mechanisms
 - Expanded diagnostics using data records
 - Complete plant monitoring using statistics data record and current value monitoring by means of data records
 - Parameterization through PROFIBUS/PROFINET bus with the help of data records from the user program
 - Control of the motor starter using a command data record from the user program
 - Removable modular control unit – quicker device replacement and therefore lower costs when device outages occur – since existing wiring is on the control unit and only one device needs to be replaced
 - Parameterization in STEP 7 HW Config using Motor Starter ES (ordering option for startup software)
 - Startup and diagnostics with the help of Motor Starter ES (ordering option for startup software)
 - Trace function through Motor Starter ES for optimized startup and tracking of process and device values
- Only with PROFINET:
- Just one bus system from the MES level to the devices – no routers
 - More stations on the bus and possible configuration of flexible bus structures
 - Automatic re-parameterization in case of device replacement thanks to proximity detection
 - Wireless integration of plant segments in difficult environments using WLAN
 - Easier expansion of the system thanks to a higher number of stations on the bus and elimination of terminating resistors



M200D motor starter module for PROFIBUS/PROFINET (without communication module)



M200D communication module for PROFIBUS



M200D communication module for PROFINET

General data

Mounting and installation

The M200D PROFIBUS/PROFINET motor starter is comprised of the communication module and the motor starter module. Only the motor starter module has to be replaced therefore when replacing devices. This saves time and money. The communication module remains as an active station on the bus and all other system components continue running. This prevents downtimes.

The integrated plug-in technology enables far lower wiring outlay: Connecting cables can be plugged directly onto the motor starter module. The PROFINET bus is connected cost-effectively using an M12 connection on the device. All versions have identical enclosure dimensions for easier system design and conversion.

Parameterization and configuration

All motor protection functions, limit values and reactions can be defined by parameterization.

The user has several user-friendly options for the parameterization. In addition to parameterization directly from STEP 7, which also permits automatic re-parameterization in case of device replacement, it is possible to use the user-friendly Motor Starter ES startup software. By connecting a programming device directly to PROFIBUS/PROFINET and the Motor Starter ES startup software, the devices can also be conveniently programmed from a central point through the bus. Also, parameters can be changed during operation from the user program using the data record mechanism so that the function of the motor starter is adapted to the process when required. With the help of a PC and the Motor Starter ES software it is also possible to perform the parameterization through the local point-to-point interface on-site.

Functions can be flexibly assigned to the digital inputs and outputs, adapting them to all possible conveyor applications. All digital inputs and outputs exist in the cyclic process image. All limit values for monitoring functions and their reactions are parameterizable and therefore adaptable to the application. Consistency with other products of the SIRIUS M200D motor starter range and with the frequency converter and ET 200pro I/O system is assured.

Only with M200D PROFINET motor starters

Thanks to the integrated proximity detection, the device name does not need to be issued manually when a device is replaced. The name is issued automatically by the neighboring devices which note the "names" of the devices in their proximity. No additional startup measures are required therefore when replacing a device.

The new motor starter generation is characterized by high functionality, maximum flexibility and the highest level of automation. PROFINET is especially recommended for large-scale and highly automated system components, since the possibility of monitoring the devices or plants with data records (statistical data, measured values and device diagnostics) ensures a broader insight into the plant by the control room, and hence increases the availability of the plant sustainably.

Operation

The motor starters record the actual current flow. Evaluating the current of the parameterizable solid-state overload protection increases the availability of the drives, as do reliable signals concerning the overshooting or undershooting of setpoint values.

Diagnostics and maintenance

Diagnostics is provided through numerous mechanisms – and can be used as the customer prefers.

The motor starter is TIA-diagnostics compatible, which means that when a fault is identified, a diagnostics alarm is distributed, which invokes the diagnostics OB in the case of a SIMATIC control. The fault can be evaluated as usual in the user program.

The M200D motor starter offers a large variety of diagnostics data through data records. Its functionality is without equal on the market. There are extensive options for reading out data from the motor starter for monitoring devices, systems or processes.

The motor starter is equipped internally with three logbooks for device faults, motor starter trips and events that are issued with a time stamp. These logbooks can be read out of the motor starter at any time in the form of data records and provide the plant operator with plenty of information about the state of his plant and process which he can use to carry out improvements.

With the slave pointer and statistical data functions it is possible to read out, for example, the maximum internal current values or the number of motor starter connection operations for plant monitoring purposes. This allows deviations in the process to be monitored, but also optimum initial commissioning to take place. The user can draw conclusions about the actual load conditions of the devices in his process and on this basis can optimize his plant maintenance intervals.

The device diagnostics data record contains details of all the states of the motor starter, the device configuration and the communication status as a basis for central device and plant monitoring.

With installation and maintenance functions (I&M), information on modules employed and data specified by the user during configuration, such as location designations, are stored in the motor starter. I&M functions are used for troubleshooting faults and localizing changes in hardware in a plant or checking the system configuration. Reordering a device is particularly easy as the result.

The integrated maintenance timer can be used to implement preventative maintenance and avoid plant downtimes through look-ahead servicing.

Another new addition is the TRACE integrated into the Motor Starter ES software. It can be used to record measured values as a function of time following a trigger event. This enables process flows to be recorded and their timing optimized.

Local control of a drive is possible using the ordering option with integrated manual operation. This is yet another new development which distinguishes the M200D PROFIBUS/PROFINET motor starter from the rest of the market and adds innovative technology, maximum availability and transparency to the system.

M200D PROFINET motor starters with PROFlenergy

Increasing energy prices, far-reaching ecological problems worldwide and the threat of climate change make it necessary for you to be more conscious about your use of energy.

Active and effective energy management is possible with PROFlenergy.

PROFlenergy is a manufacturer-independent profile on PROFINET, which can be used by all manufacturers, has been standardized by PNO¹⁾ and supports switching off electrical devices during dead times and measuring the energy flow.

¹⁾ In the PNO (PROFIBUS Nutzerorganisation e. V. – PROFIBUS User Organization), manufacturers and users have come together to agree on the PROFIBUS and PROFINET standardized communication technologies.

SIRIUS M200D motor starters for PROFIBUS/PROFINET

General data

Switching off during dead times

PROFenergy supports the targeted switching-off of loads during dead time.

These can be planned short breaks of a few minutes (such as lunch breaks), longer dead times (such as nights) or unplanned dead times. Energy is always saved when no power is required.

Measuring and visualizing the energy flow as a basis of energy management

The objective of energy management is to optimize the use of energy in a company – from the purchasing of energy through to the consumption of energy – economically and ecologically.

Analyses of energy consumption over time can be used to control energy flows, avoid energy peaks, improve ratings and thus save costs.

PROFenergy enables consumption data to be read off from the devices in a unified form. This is recorded during operation and can be displayed on a control panel, for example, or sent to overlying energy management software packages. This ensures that the measured variables are in a uniform manufacturer-independent form and structure that is available to the user for further processing. These PROFenergy functions thus provide the basis for active load and energy management during operation.

PROFenergy in the M200D PROFINET motor starter

The M200D PROFINET motor starter supports the "switching during dead times" and "current measurement values" functions of the motor current using PROFenergy. These are called commands, because they trigger a reaction in the M200D motor starter.



**SIRIUS M200D
PROFIBUS**

**SIRIUS M200D
PROFINET**

Device functions (firmware features)		
Slave on the bus		
Fieldbus	✓ PROFIBUS to M12	✓ PROFINET to M12
Adjustable number of stations	✓ 1 ... 125	✓ 1 ... 128 with CPU 315, CPU 317 1 ... 1256 with CPU 319
Parameter assignment		
DIP switches	✓ For address setting and terminating resistor	--
Motor Starter ES	✓ Through bus, optical interface	
PROFIBUS/PROFINET data records	✓	
From STEP 7/HW Config	✓	
Diagnostics		
Acyclic through data records	✓	
Diagnostic interrupt support	✓	
Process image		
Process image	✓ 2 bytes PAE/2 bytes PAA	
Data channels		
Local optical interface (manual local)	✓	
Motor Starter ES through local interface	✓	
Using Motor Starter ES through bus	✓	
Data records (acyclic)		
Parameter assignment	✓ Using DS 131 (DS = data record)	
Diagnostics	✓ Device-specific DS 92	
Measured values	✓ Measured values DS 94	
Statistics	✓ Statistical data DS 95	
Commands	✓ Using DS 93	
Slave pointer	✓ Slave pointer DS 96	
Logbook	✓ Using Motor Starter ES and data records: device faults DS 72, tripping operation DS 73, events DS 75	
Device identification	✓ Using DS 100	
I&M data	✓ Using DS 231 ... 234	✓ Using data records 0xAFF0 ... 0xAFF3
Inputs		
Number	✓ 4	
• Of these in the process image	✓ 4	
Input action	✓ Parameterizable: For flexibly assignable action, see manual	
Quick stop	✓ Parameterizable: latching, non-latching	

✓ Function available
-- Function not available

General data



SIRIUS M200D
PROFIBUS

SIRIUS M200D
PROFINET

Device functions (firmware features) (continued)

Outputs

Number	✓ 2
• Of these in the process image	✓ 2
Output action	✓ Parameterizable: For flexibly assignable action, see manual

Brake output

180 V DC / 230/400 V AC / none	✓
--------------------------------	---

Motor protection

Overload protection	✓ Electronic, wide range 1:10
Short-circuit protection	✓
Full motor protection	✓
Temperature sensor	✓ Parameterizable via Motor Starter ES, data record: PTC or Thermoclick or deactivated

Device function

Repair switch	✓
Current limit monitoring bottom	✓ Parameterizable
Current limit monitoring top	✓ Parameterizable
Zero current detection	✓ Parameterizable: tripping, warning
Blocking current	✓ Parameterizable
Asymmetry	✓ Parameterizable
Load type	✓ Parameterizable: single-phase and three-phase
Shutdown class	✓ Parameterizable via Motor Starter ES, data record: CLASS 5, 10, 15, 20
Protection against voltage failure	✓ Parameterizable: activated/deactivated

Support for PROFlenergy profile

Switching during dead times	--	3
Measured motor current values	--	3

Soft starter control function

Soft start function	✓
Bypass function	✓ Only solid-state version

- ✓ Function available
- Function not available

Benefits

M200D PROFINET motor starters with PROFlenergy

Both standards and laws are making environmental protection and energy management increasingly important, as is the desire to cut energy costs in production facilities and thus ensure a sustainable competitive advantage.

It is thus an objective within the industry to save energy and actively reduce CO₂ emissions. By the careful use of valuable resources, the manufacturer-independent PROFlenergy profile on PROFINET can make an active contribution to environmental protection.

Application

M200D PROFIBUS/PROFINET motor starters are particularly suitable for fully TIA-integrated, highly automated conveyor applications that meet all needs with regard to the monitoring of devices and systems and preventive maintenance.

Adaptability of the motor starter functions and maximum flexibility of the device enable a broad range of application without any limits. The PROFINET-specific expansions are the best assurance of a future-proof investment.

Technical specifications

More information

Equipment Manual for M200D PROFIBUS/PROFINET, see <https://support.industry.siemens.com/cs/ww/en/view/38823402>
 FAQs, see <https://support.industry.siemens.com/cs/ww/en/ps/16325/faq>

Notes on security:

In order to protect plants, systems, machines and networks against cyber threats, it is necessary to implement – and continuously maintain – a holistic, state-of-the-art industrial security concept. Siemens products and solutions represent only one component of such a concept.

For more information on the subject of Industrial Security, see www.siemens.com/industrialsecurity.

Type	M200D PROFIBUS/PROFINET motor starter modules	
Technology designation ¹⁾	Electromechanical switching DSte/RSSte	Electronic switching sDSSte/sRSSte
Mechanics and environment		
Mounting dimensions (W x H x D)		
• Without communication module	mm	294 x 215 x 159
• With communication module	mm	295 x 215 x 163
Permissible ambient temperature		
• During operation	°C	-25 ... +55
• During storage	°C	-40 ... +70
Weight	g	2 820/3 080
Permissible mounting position		3 160/3 360
Vibration resistance acc. to IEC 60068 Part 2-6	g	Vertical, horizontal, lying 2
Shock resistance		
• Acc. to IEC 60068 Part 2-27	g/ms	12/11 half-sine
• Without influencing the contact position	g/ms	9.8/5 or 5.9/10
Degree of protection acc. to IEC 529		IP65
Installation altitude		
• Up to 1 000 m		No derating
• Up to 2 000 m		1% per 100 m
Cooling		Convection
Protection class IEC 536 (VDE 0106-1)		1
Electrical specifications		
Main circuit		
Maximum power of three-phase motors at 400 V AC	kW	5.5
Rated operational voltage U_e		
• Approval acc. to EN 60947-1	V AC	400 (50/60 Hz)
• Approval acc. to UL and CSA	V AC	600 (50/60 Hz)
• Rated operational current range	A	0.15 ... 2/1.5 ... 12
• Rated operational current range for soft starting	A	--
• Rated operational current range for direct-on-line starting	A	480 (50/60 Hz) -- 0.15 ... 2/1.5 ... 12 0.15 ... 2/1.5 ... 9
Rated operational current for starters I_e at 400 V AC		
• 400 V at AC-1/2/3	A	12
• 500 V at AC-1/2/3	A	9
• 400 V at AC-4	A	4
• 400 V at AC-53a	A	--
		12 for soft starting, 9 for direct-on-line starting
Mechanical endurance of contactor	Operating cycles	30 million
Trip class		CLASS 5, 10, 15, 20
Permissible switching frequency		see manual
Rated ultimate short-circuit breaking capacity I_q		
• At 400 V AC	kA	50
• At 500 V AC	kA	50
		20 ²⁾
Short-circuit protection		
• At $I_{e\max} = 2$ A		Integrated, $2 \times 13 I_e = 26$ A
• At $I_{e\max} = 9/12$ A		Integrated, $2 \times 13 I_e = 208$ A

- ¹⁾ DS Direct-on-line starters
 RS Reversing starters
 DSS .. Direct-on-line soft starters
 RSS .. Reversing soft starters
 te Full motor protection (thermal + electronic)
 s Electronic switching with semiconductor.

- ²⁾ Only systems with grounded neutral point permitted.

General data

		Line voltage				
		380 V AC	400 V AC	440 V AC	480 V AC	500 V AC
Brake voltage with brake actuation 180 V DC¹⁾						
Operational voltage	V	230/400 AC or 180 DC				
Uninterrupted current	A	< 0.5 at 230/400 V AC, < 0.8 at 180 V DC				
Short-circuit protection		Yes, 1 A melting fuse				
Rectified brake voltage	V DC	171	180	198	216	225
Recommended brake coil voltage for Siemens motors	V DC	170 ... 200	170 ... 200	184 ... 218	184 ... 218	--

¹⁾ Integrated brake actuation supplies DC power supply for the brake.

Type	M200D communication modules	
	For PROFIBUS	For PROFINET
Mechanics and environment		
Mounting dimensions (W x H x D)	mm	174 x 139 x 40
Permissible ambient temperature		
• During operation	°C	-25 ... +55
• During storage	°C	-40 ... +70
Weight	g	300
Permissible mounting position		Vertical, horizontal, lying
Vibration resistance acc. to IEC 60068 Part 2-6	g	2
Shock resistance		
• Acc. to IEC 60068 Part 2-27	g/ms	12/11 half-sine
• Without influencing the contact position	g/ms	9.8/5 or 5.9/10
Degree of protection acc. to IEC 529		IP65
Installation altitude		
• Up to 1 000 m		No derating
• Up to 2 000 m		1% per 100 m
Cooling		Convection
Protection class IEC 536 (VDE 0106-1)		1
Electrical specifications		
Control circuit		
Operational voltage		
• $U_{DC24V-NS}$	V DC	20.4 ... 28.8
• $U_{DC24V-S}$	V DC	20.4 ... 28.8
Power consumption from		
• $U_{DC24V-NS}$	mA	< 300
• $U_{DC24V-S}$	mA	< 100

SIRIUS M200D motor starters for PROFIBUS/PROFINET

Communication modules, motor starter modules

Selection and ordering data



M200D motor starter module
PROFIBUS/PROFINET
(without communication module)



M200D motor starter
PROFIBUS



M200D motor starter
PROFINET

Version	SD	Article No.	Price per PU	PU (UNIT, SET, M)	PS*
d					
M200D communication modules for PROFIBUS					
Communication module for PROFIBUS M12 connection for communication, 7/8" for 24 V power supply	15	3RK1305-0AS01-0AA0		1	1 unit
M200D communication modules for PROFINET					
Communication module for PROFINET M12 connection for communication, 7/8" for 24 V power supply	15	3RK1335-0AS01-0AA0		1	1 unit
M200D PROFIBUS/PROFINET motor starter modules					
Electromechanical starters (with integrated contactor)					
	15	3RK1395-6□S41-□AD□		1	1 unit
Rated operational current setting range/A				Additional price	
• 0.15 ... 2				None	
• 1.5 ... 12				✓	
Direct-on-line starters/reversing starters				None	
• Direct-on-line starters				None	
• Reversing starters				✓	
• Direct-on-line starters with manual local operation				✓	
• Reversing starters with manual local operation				✓	
Brake actuation				None	
• Without brake actuation				None	
• Brake actuation (230/400 V AC)				✓	
• Brake actuation (180 V DC)				✓	

Electronic starters (with thyristors)

	15	3RK1395-6□S71-□AD□		1	1 unit
Rated operational current setting range/A				Additional price	
• 0.15 ... 2				None	
• 1.5 ... 12				✓	
Direct-on-line starters/reversing starters				None	
• Direct-on-line starters				None	
• Reversing starters				✓	
• Direct-on-line starters with manual local operation				✓	
• Reversing starters with manual local operation				✓	
Brake actuation				None	
• Without brake actuation				None	
• Brake actuation (230/400 V AC)				✓	
• Brake actuation (180 V DC)				✓	

✓ = Additional price

Overview

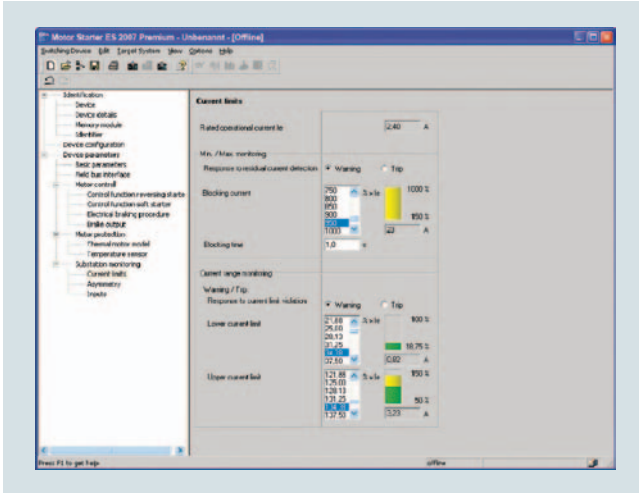

Motor Starter ES for parameterization, monitoring, diagnostics and testing of motor starters

More information

Industry Mall, see www.siemens.com/product?3ZS1

Technical specifications and system requirements, see <https://support.industry.siemens.com/cs/ww/en/ps/16713/td>

Motor Starter ES is used for the startup, parameterization, diagnostics, documentation and preventive maintenance of SIMATIC ET 200S, ET 200pro, ECOFAST and M200D motor starters.

The software program is available in three versions which differ in their user-friendliness, scope of functions and price.

Overview

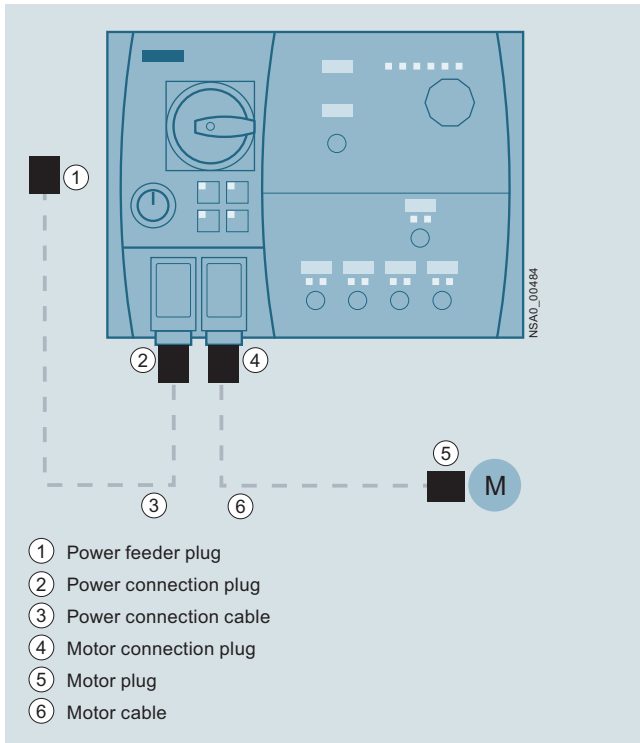

Power and motor connection on the M200D motor starter (in this example: M200D for AS-i)

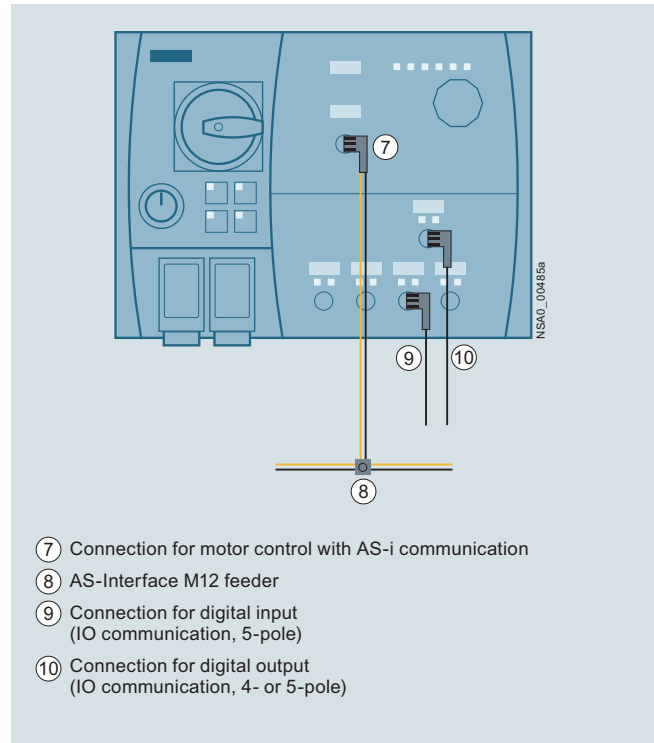

Communication connection using AS-Interface and digital inputs and outputs

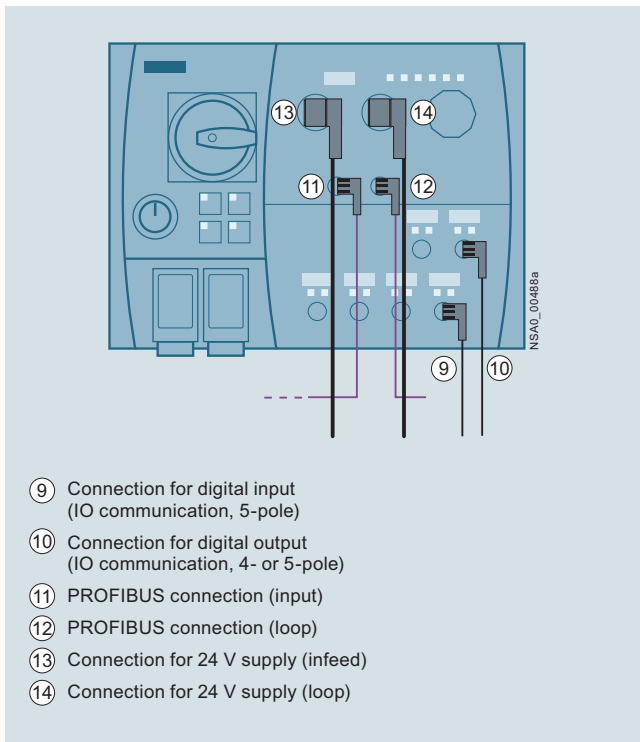

Communication connection using PROFIBUS and digital inputs and outputs

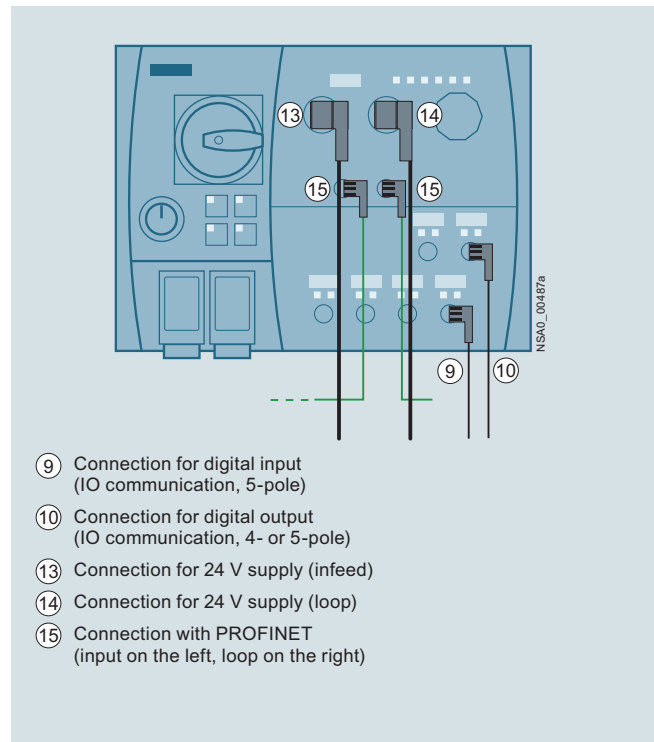

Communication connection using PROFINET and digital inputs and outputs

SIRIUS M200D Motor Starters

Accessories for all M200D motor starters

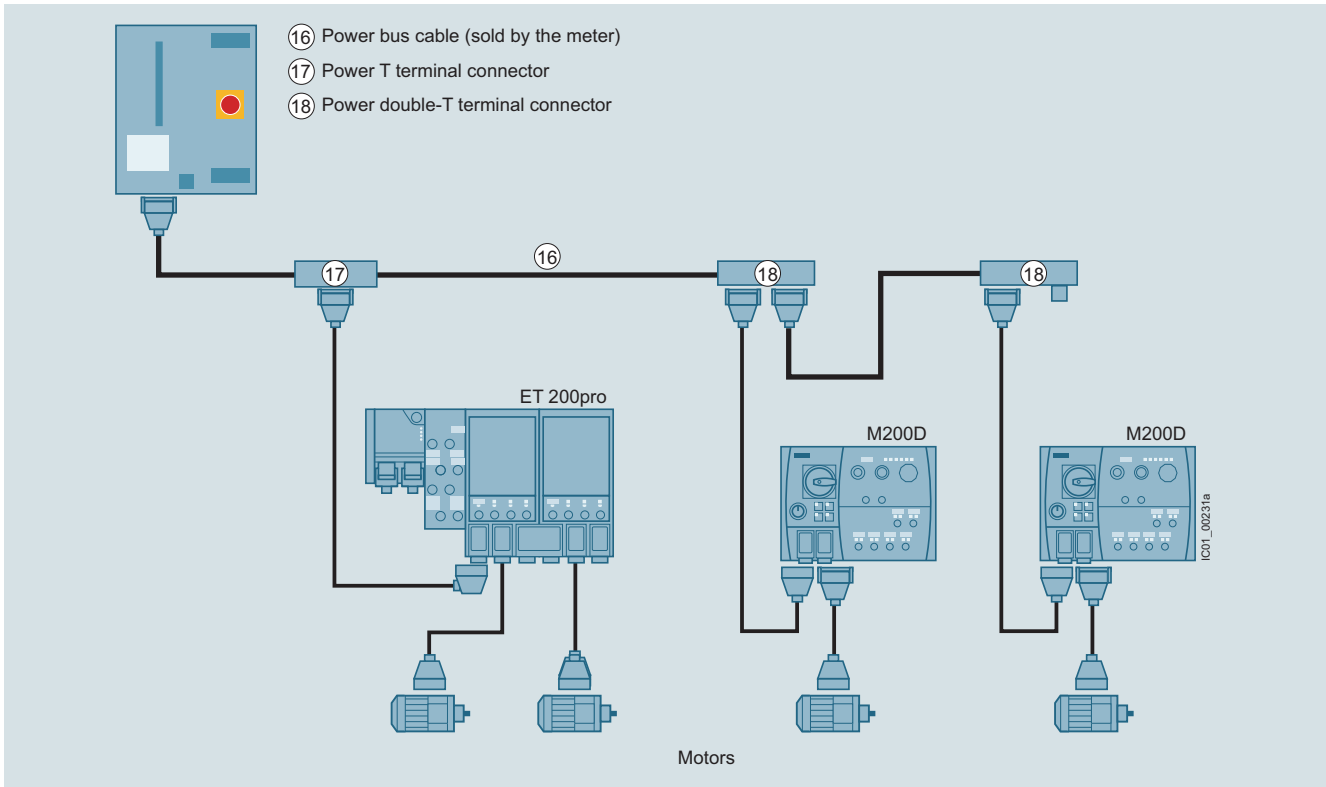

Power supply to the motors via the power bus with power T and double-T terminal connectors linked by power bus cables, spur lines to the field devices (motor starters), and power loop-through connections to the motors via motor connection cables

Power bus

The power supply to the field devices (ET 200pro motor starters, M200D motor starters) is provided via the power bus, in which the power T terminal connectors or power double-T terminal connectors are connected by power bus cables.

Feeders

From the terminal connectors, spur lines with Han Q4/2 plugs lead to the field devices, from which the motors are supplied with power via motor connection cables.

Interruption-free thanks to power terminal connectors

In finger-safe connection technology the power T terminal connectors and power double-T terminal connectors connect the components of a feeder to the power bus. They ensure interruption-free operation, i.e. the power bus is not interrupted when the components are unplugged.

SIRIUS M200D Motor Starters



Accessories for all M200D motor starters

Selection and ordering data

The accessories listed below represent a basic selection sorted by:

- Accessories for all M200D motor starters
- Accessories for M200D motor starters for AS-Interface
- Accessories for M200D motor starters for PROFIBUS
- Accessories for M200D motor starters for PROFINET

Version	SD	Article No.	Price per PU	PU (UNIT, SET, M)	PS*
	d				
Mountable accessories					
M200D protective brackets					
	5	3RK1911-3BA00		1	1 unit
Incoming power supply					
① Power feeder plugs					
Connector set for incoming power supply, e.g. for connecting to T terminal connectors, comprising a coupling enclosure, straight outgoing feeder (with bracket), pin insert for HAN Q4/2, incl. gland					
• 5 male contacts, 2.5 mm ²	5	3RK1911-2BS60		1	1 unit
• 5 male contacts, 4 mm ²	5	3RK1911-2BS20		1	1 unit
• 5 male contacts, 6 mm ²	5	3RK1911-2BS40		1	1 unit
② Power connection plugs					
Connector set for incoming power supply for connection to M200D motor starters, comprising a cable-end connector hood, angular outgoing feeder, female insert for HAN Q4/2, incl. gland					
• 5 female contacts, 2.5 mm ² , 2 female contacts, 0.5 mm ²	5	3RK1911-2BE50		1	1 unit
• 5 female contacts, 4 mm ² , 2 female contacts, 0.5 mm ²	5	3RK1911-2BE10		1	1 unit
• 5 female contacts, 6 mm ² , 2 female contacts, 0.5 mm ²	5	3RK1911-2BE30		1	1 unit
② + ③ Power connection cables					
Assembled at one end with "N" and jumper pin 11 and 12 for plug monitoring, with HAN Q4/2, angular, open at one end; 5 x 4 mm ²					
• Length 1.5 m	10	3RK1911-0DC13		1	1 unit
• Length 5.0 m	10	3RK1911-0DC33		1	1 unit
Motor cables					
④ Motor connection plugs					
Connector set for motor cable for connection to M200D motor starters, comprising a cable-end connector hood, angular outgoing feeder, pin insert for HAN Q8/0, incl. gland					
• 8 male contacts, 1.5 mm ²	5	3RK1902-0CE00		1	1 unit
• 6 male contacts, 2.5 mm ²	5	3RK1902-0CC00		1	1 unit
⑤ Motor plugs					
Connector set for motor cable for connection to motors, comprising a cable-end connector hood, straight outgoing feeder, female insert for HAN 10e, incl. star jumper, incl. gland					
• 7 female contacts, 1.5 mm ²	30	3RK1911-2BM21		1	1 set
• 7 female contacts, 2.5 mm ²	30	3RK1911-2BM22		1	1 set
④ + ⑥ Motor cables, assembled at one end					
For connection to M200D motor starters, HAN Q8/0, angular, length 5 m					
• Motor cables for motor without brake, 4 x 1.5 mm ²	15	3RK1911-0EB31		1	1 unit
• Motor cables for motor without brake with thermistor, 6 x 1.5 mm ²	30	3RK1911-0EF31		1	1 unit
• Motor cables for motor with brake actuation, braking voltage 400 V AC or 180 V DC, 6 x 1.5 mm ²	30	3RK1911-0ED31		1	1 unit
• Motor cables for motor with brake actuation, braking voltage 400 V AC or 180 V DC and thermistor, 8 x 1.5 mm ²	30	3RK1911-0EG31		1	1 unit
• Motor cables for motor with brake actuation, braking voltage 230 V AC, 6 x 1.5 mm ²	30	3RK1911-0EH31		1	1 unit
• Motor cables for motor with brake actuation, braking voltage 230 V AC and thermistor, 8 x 1.5 mm ²	30	3RK1911-0EE31		1	1 unit

Version	SD	Article No.	Price per PU	PU (UNIT, SET, M)	PS*
	d				
Power bus					
⑰ Power T terminal connectors					
For 400 V AC, for connection of feeders (e.g. motor starters) by means of standard round cable at any point of the power bus, by insulation displacement connection, used with preassembled bus segments					
• 2.5 mm ² /4 mm ²	5	3RK1911-2BF01		1	1 unit
• 4 mm ² /6 mm ²	5	3RK1911-2BF02		1	1 unit
⑱ Power double-T terminal connectors					
For 400 V AC, for connection of feeders (e.g. motor starters) by means of standard round cable at any point of the power bus, by insulation displacement connection, used with preassembled bus segments, connection of two motor starters possible					
• 4 mm ² /6 mm ²	5	3RK1911-2BG02		1	1 unit
Sealing set (comprising 2 seals)					
For power T/power double-T terminal connectors					
• For power cables with					
- Ø 10 ... 13 mm	5	3RK1911-5BA00		1	1 unit
- Ø 13 ... 16 mm	5	3RK1911-5BA10		1	1 unit
- Ø 16 ... 19 mm	5	3RK1911-5BA20		1	1 unit
- Ø 19 ... 22 mm	X	3RK1911-5BA30		1	1 unit
• Blanking plugs	5	3RK1911-5BA50		1	1 unit
Further accessories for power connections					
		Crimping tools for pins/sockets 4 mm² and 6 mm²	15	3RK1902-0CW00	1 1 unit
3RK1902-0CW00					
Dismantling tools					
• For male and female contacts for 9-pole HAN Q4/2 inserts	15	3RK1902-0AB00		1	1 unit
• For male and female contacts for 9-pole HAN Q8 inserts	5	3RK1902-0AJ00		1	1 unit
Sealing caps					
For 9-pole power sockets					
• 1 unit per pack	5	3RK1902-0CK00		1	1 unit
• 10 units per pack	5	3RK1902-0CJ00		1	10 units
					
3RK1902-0CK00					





SIRIUS M200D Motor Starters

Accessories for all M200D motor starters

Version	SD	Article No.	Price per PU	PU (UNIT, SET, M)	PS*
Motor control with I/O communication					
 3RK1902-4BA00-5AA0		M12 plugs, straight Screw fixing, 5-pole screw terminals, max. 0.75 mm ² , A-coded, max. 4 A	5	3RK1902-4BA00-5AA0	1 1 unit
 3RK1902-4DA00-5AA0		⑩ M12 plugs, angular Screw fixing, 5-pole screw terminals, max. 0.75 mm ² , A-coded, max. 4 A	5	3RK1902-4DA00-5AA0	1 1 unit
 3RK1902-4H...-5AA0		⑨, ⑩ Control cables, assembled at one end M12 plugs, angular, screw fixing, 5-pole, 5 x 0.34 mm ² , A-coded, black PUR sheath, max. 4 A • Cable length 1.5 m • Cable length 5 m • Cable length 10 m	5 5 5	3RK1902-4HB15-5AA0 3RK1902-4HB50-5AA0 3RK1902-4HC01-5AA0	1 1 unit 1 1 unit 1 1 unit
 3RK1902-4PB15-3AA0		Control cables, assembled at both ends Straight M12 plug, straight M12 socket, screw fixing, 3-pole, 3 x 0.34 mm ² , A-coded, black PUR sheath, max. 4 A • Cable length 1.5 m	5	3RK1902-4PB15-3AA0	1 1 unit
Further accessories					
 3RK1922-3BA00		Handheld devices For M200D motor starters (or for ET 200pro and ET 200S High Feature motor starters) for local operation. The motor starter-specific serial interface cables must be ordered separately. The RS 232 interface cable 3RK1922-2BP00 is used for the MS M200D.	5	3RK1922-3BA00	1 1 unit
		RS 232 interface cable Serial data connection between M200D (or ET 200pro) motor starters and the RS 232 interface of a PC/PG/laptop (with the Motor Starter ES software) or the handheld device 3RK1922-3BA00	5	3RK1922-2BP00	1 1 unit
		USB interface cable, 2.5 m Serial data connection between M200D (or ET 200pro) motor starters and the USB interface of a PC/PG/laptop (with the Motor Starter ES software).	3	6SL3555-0PA00-2AA0	1 1 unit
 3RK1901-1KA00		M12 sealing caps For sealing unused M12 input or output sockets and M12 sockets for PROFIBUS and PROFINET communication modules (one set contains ten sealing caps)	▶	3RK1901-1KA00	100 10 units
 3SU1950-0FB80-0AA0		RONIS SB30 keys Replacement key for M200D for "manual local control" ordering option	▶	3SU1950-0FB80-0AA0	1 1 unit



For more connection technology products, see <https://support.industry.siemens.com/cs/ww/en/view/65355810..>

Selection and ordering data





Version	SD	Article No.	Price per PU	PU (UNIT, SET, M)	PS*
Motor control with AS-i communication					
 3RK1902-4GB50-4AA0		⑦ Control cables, assembled at one end M12 plug, angular, screw fixing, 4-pole, 4 x 0.34 mm ² , A-coded, black PUR sheath, max. 4 A • Cable length 5 m	5	3RK1902-4GB50-4AA0	1 1 unit
 3RK1902-4CA00-4AA0		⑦ M12 sockets, angled For screw fixing, 4-pole screw terminals, max. 0.75 mm ² , A-coded, max. 4 A	5	3RK1902-4CA00-4AA0	1 1 unit
⑧ AS-Interface M12 feeders					
 3RK1901-2NR21	For flat cable	For	Cable length	Cable end in feeder	
	AS-i/U _{aux}	M12 socket	--	not available	2 3RK1901-2NR20 1 1 unit
		M12 cable box	1 m	not available	2 3RK1901-2NR21 1 1 unit
			2 m	not available	2 3RK1901-2NR22 1 1 unit
 3RK1901-1MN00		Cable terminating pieces For sealing of open cable ends (shaped AS-Interface cable) in IP67		3RK1901-1MN00	1 10 units
AS-Interface shaped cable, see also page 2/82					
	Material	Color	Quantity		
 3RX90...-0AA00	Rubber	Yellow (AS-Interface)	100 m roll	2	3RX9010-0AA00 1 1 unit
			1 km drum	5	3RX9012-0AA00 1 1 unit
		Black (24 V DC)	100 m roll	2	3RX9020-0AA00 1 1 unit
			1 km drum	5	3RX9022-0AA00 1 1 unit
TPE	Yellow (AS-Interface)	100 m roll	2	3RX9013-0AA00 1 1 unit	
		1 km drum	5	3RX9014-0AA00 1 1 unit	
	Black (24 V DC)	100 m roll	2	3RX9023-0AA00 1 1 unit	
		1 km drum	5	3RX9024-0AA00 1 1 unit	
TPE special version according to UL Class 2	Yellow (AS-Interface)	100 m roll	5	3RX9017-0AA00 1 1 unit	
	Black (24 V DC)	100 m roll	5	3RX9027-0AA00 1 1 unit	
PUR	Yellow (AS-Interface)	100 m roll	2	3RX9015-0AA00 1 1 unit	
		1 km drum	5	3RX9016-0AA00 1 1 unit	
	Black (24 V DC)	100 m roll	2	3RX9025-0AA00 1 1 unit	
		1 km drum	5	3RX9026-0AA00 1 1 unit	

SIRIUS M200D Motor Starters

Accessories for M200D motor starters for AS-Interface

Version	SD	Article No.	Price per PU	PU (UNIT, SET, M)	PS*
Further accessories					
	2	3RK1904-2AB02		1	1 unit
<p>AS-Interface addressing unit V3.0</p> <ul style="list-style-type: none"> • For AS-Interface modules and sensors and actuators with integrated AS-Interface according to AS-i Specification V3.0 • For setting the AS-i address of standard slaves, and slaves with extended addressing mode (A/B slaves) • With input/output test function and many other commissioning functions • Battery operation with four type AA batteries (IEC LR6, NEDA 15) • Scope of supply: <ul style="list-style-type: none"> - Addressing unit with four batteries - Addressing cable, with M12 plug to addressing plug (hollow plug), length 1.5 m 					
	5	3RK1902-4PB15-3AA0		1	1 unit
<p>M12 addressing cables to M12</p> <ul style="list-style-type: none"> • Standard M12 cable for addressing slaves with M12 connection, e.g. K60R modules • When using the current version of the 3RK1904-2AB01 addressing unit • 1.5 m 					
"SIRIUS M200D Motor Starter" manuals					
<p>Equipment Manual - SIRIUS M200D AS-Interface Basic Motor Starter, see https://support.industry.siemens.com/cs/ww/en/view/35016496</p>					
<p>Equipment Manual - SIRIUS M200D AS-Interface Basic Motor Starter, see https://support.industry.siemens.com/cs/ww/en/view/38722160</p>					







Selection and ordering data

Version	SD	Article No.	Price per PU	PU (UNIT, SET, M)	PS*
Motor control with PROFIBUS					
		M12 plugs, angular For screw fixing, 5-pole screw terminal, max. 0.75 mm ² , B-coded, no terminating resistor			
3RK1902-1DA00	5	• ⑪ 5 female contacts		1	1 unit
		• ⑫ 5 male contacts		1	1 unit
3RK1902-1BA00	5				
		Control cables, assembled at one end M12, screw fixing, angular, B-coded, no terminating resistor			
3RK1902-1G.	15	• ⑪ 5 female contacts, 3 m		1	1 unit
	15	• ⑪ 5 female contacts, 5 m		1	1 unit
	15	• ⑪ 5 female contacts, 10 m		1	1 unit
		⑪ ⑫ Control cables, assembled at both ends M12, screw fixing, angular, pin/socket 5-pole, B-coded, no terminating resistor			
3RK1902-1N.	15	• 3.0 m		1	1 unit
	15	• 5.0 m		1	1 unit
	15	• 10.0 m		1	1 unit
Further accessories					
	1	PROFIBUS trailing cables Max. acceleration 4 m/s ² , at least 3 000 000 bending cycles, bending radius at least 60 mm, 2-core, shielded, sold by the meter, minimum order quantity 20 m, maximum order quantity 1 000 m		1	1 M
	1	PROFIBUS FC Food bus cables with PE outer sheath for operation in the food and beverage industry, 2-core, shielded, sold by the meter, minimum order quantity 20 m, maximum order quantity 1 000 m		1	1 M
	1	PROFIBUS FC Robust bus cables with PUR outer sheath for operation in environments exposed to chemicals and mechanical loads, 2-core, shielded, sold by the meter, minimum order quantity 20 m, maximum order quantity 1 000 m		1	1 M
	1	Power cables 5-core, 5 x 1.5 mm ² , trailing, sold by the meter, minimum order quantity 20 m, maximum order quantity 1 000 m		1	1 M
Connection for 24 V power supply of the M200D PROFIBUS/PROFINET					
See page 6/65					
Equipment Manual "SIRIUS M200D PROFIBUS/PROFINET Motor Starters"					
See https://support.industry.siemens.com/cs/ww/en/view/38823402					

SIRIUS M200D Motor Starters

Accessories for M200D motor starters for PROFINET

Selection and ordering data

Version	SD	Article No.	Price per PU	PU (UNIT, SET, M)	PS*
Motor control with PROFINET					
		⑮ M12 plugs, angular For screw fixing, 4-pole screw terminal, max. 0.75 mm ² , angular, D-coded			
	5	• 4 male contacts		1	1 unit
		⑮ Control cables, assembled at one end M12 for screw fixing, angular, 4-pole, D-coded,			
	15	• 4 male contacts, 3 m		1	1 unit
	15	• 4 male contacts, 5 m		1	1 unit
	15	• 4 male contacts, 10 m		1	1 unit
		⑮ Control cables, assembled at both ends M12 for screw fixing, angular at both ends, 4-pole, D-coded, male contacts at both ends			
	15	• 3 m		1	1 unit
	15	• 5 m		1	1 unit
	15	• 10 m		1	1 unit
Further accessories					
	1	PROFINET IE FC TP standard cable GP 2 x 2 Sold by the meter		1	1 M
	1	PROFINET IE FC TP trailing cable 2 x 2 Sold by the meter		1	1 M
	1	PROFINET IE FC TP trailing cable GP 2 x 2 Sold by the meter		1	1 M
	1	PROFINET IE FC TP torsion cable 2 x 2 Sold by the meter		1	1 M
	1	PROFINET IE FC TP marine cable, 4-core Sold by the meter		1	1 M
	1	Power cables 5-core, 5 x 1.5 mm ² , trailing, sold by the meter, minimum order quantity 20 m, maximum order quantity 1 000 m		1	1 M
Connection for 24 V power supply of the M200D PROFIBUS/PROFINET					
		Plugs On M200D, 7/8" for screw fixing, angular, screw terminal, 1.5 mm ²			
	5	• ⑬ 5 female contacts		1	1 unit
	5	• ⑭ 5 male contacts		1	1 unit
					
		⑬ Supply lines, assembled at one end 7/8" for screw fixing, angular, 1.5 mm ²			
	15	• 5 female contacts, 3 m		1	1 unit
	15	• 5 female contacts, 5 m		1	1 unit
	15	• 5 female contacts, 10 m		1	1 unit
		⑬ ⑭ Supply lines, assembled at both ends 7/8", for screw fixing, angular at both ends, 5-pole pin/socket, 1.5 mm ²			
	15	• 3 m		1	1 unit
	15	• 5 m		1	1 unit
	15	• 10 m		1	1 unit
	1	7/8" sealing caps 1 pack = 10 units		1	10 units
Equipment Manual "SIRIUS M200D PROFIBUS/PROFINET Motor Starters"					
See https://support.industry.siemens.com/cs/ww/en/view/38823402					

Overview

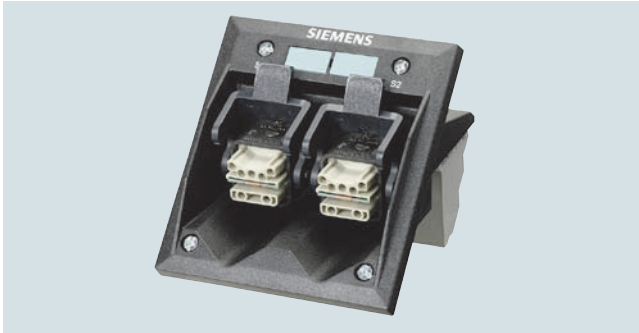

Hybrid fieldbus connection with two HanBrid sockets



Control cabinet bushing with two M12 sockets

Hybrid fieldbus connections with HanBrid sockets designed as cabinet bushings transmit data and energy from the control cabinet (IP20) to the field (IP65). They are the interface for jointly routing PROFIBUS DP and the auxiliary voltages into the hybrid fieldbus cable.

On the cabinet bushings with two M12 sockets for the PROFIBUS M12 connecting cables, the 24 V supply of the motor starters is implemented via separate 7/8" connecting cables.

Passive and active hybrid fieldbus connections

The hybrid fieldbus connections are available in two versions which differ in their functionality:

- Passive version
- Active version with signal refresher function to considerably increase the maximum PROFIBUS cable length

Connection methods

The field side is connected using HanBrid or M12 plug-in connections.

In the case of HanBrid, the following versions are available:

- Socket/socket for feeding into the field
- Pin/socket for looping through in the field

The M12 version is generally configured with socket/socket.

Following connections are available at the rear (cabinet side) in the case of the passive bushings:

- Direct connection
- FastConnect connection

The active bushing with refresher function has 9-pole Sub D sockets for the rear connection.

Auxiliary power infeed

HanBrid plug-in connection technology offers the option of feeding in or looping through two separate auxiliary voltages of 24 V DC (switched/unswitched) into the field in addition to the PROFIBUS signal. The terminal block with spring-loaded terminals on the rear (cabinet side) of the hybrid fieldbus connection provides a variety of interconnecting options for these auxiliary voltages.

Passive hybrid fieldbus connections

- Bushing from the control cabinet (IP20) into the field (IP65)
- HanBrid plug-in design socket/socket or pin/socket
- Direct connection or FastConnect connection for PROFIBUS at the rear
- Terminal block with spring-loaded terminals (0.25 to 2.5 mm²) for infeeding or forwarding the auxiliary voltages

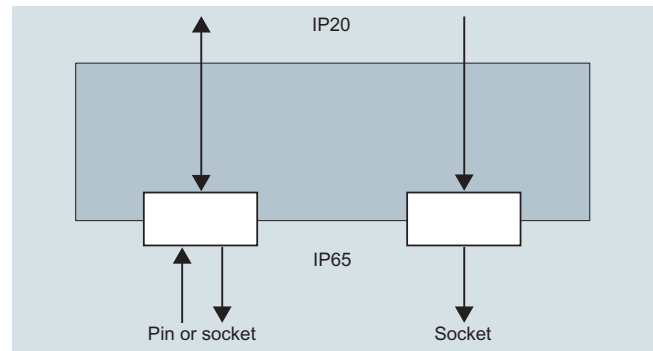

Hybrid fieldbus connection as passive cabinet bushing

Active hybrid fieldbus connections with refresher function

- Bushing from the control cabinet (IP20) into the field (IP65)
- Three independent, electrically separated PROFIBUS segments
- Signal refresher function from and to all segments
- Automatic continuous baud rate detection
- Status/diagnostics displays with LEDs
- Cascading depth of a maximum nine hybrid fieldbus connections
- HanBrid plug-in design socket/socket and pin/socket
- M12 plug-in design socket/socket
- 9-pole Sub D socket connection for PROFIBUS at the rear
- Terminal block with spring-loaded terminals (0.25 to 2.5 mm²) for infeeding or forwarding the auxiliary voltages

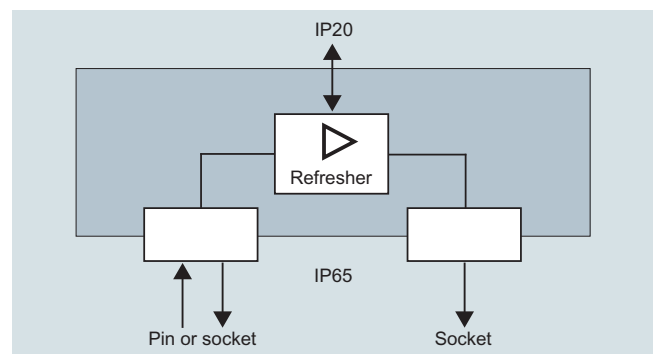

Hybrid fieldbus connection as active control cabinet bushing with refresher function

Hybrid fieldbus connections

Selection and ordering

Technical specifications

Type		Passive hybrid fieldbus connections	Active hybrid fieldbus connections
Mechanics and environment			
Dimensions (W x H x D)	mm	93 x 103 x 65	
Cutout (W x H)	mm	80 x 90	
Temperature range	°C	-25 ... +60	
Degree of protection		IP20 internal/IP65 on field side	
Material/enclosure	mm	Plastic (black PC), flame retardant	
Electrical specifications			
Rated operational voltage			
• 24 V DC not switched (NS)	V DC	24, ± 25%	
• 24 V DC switched (S)	V DC	24, ± 25%	
Max. rated current	A	10	
Power supply		--	From 24 V DC not switched (NS)
Max. power consumption	mA	--	130
Mains buffering	ms	--	> 20
Baud rate detection		--	Automatic
Maximum cascading depth		--	9 hybrid fieldbus connections
Baud rates	kbps	9.6/19.2/45.45/93.75/187.5/500/1 500/3 000/6 000 /12 000	
Electrical separation	V DC	500	

Selection and ordering data



Hybrid fieldbus connection on the field side:
With socket/socket (HanBrid)



With pin/socket (HanBrid)



Control cabinet bushing on the field side
With socket/socket (M12)

Link type / function	Connection IP65	Connection IP20 (PROFIBUS)	SD	Article No.	Price per PU	PU (UNIT, SET, M)	PS*
Hybrid fieldbus connections							
Passive							
• Cu/Cu, for feeding into the field	Socket/socket (2 x HanBrid)	Direct connection	5	3RK1911-1AA22		1	1 unit
• Cu/Cu, for looping through in the field	Pin/socket (2 x HanBrid)	Direct connection	5	3RK1911-1AA32		1	1 unit
• Cu/Cu, for feeding into the field	Socket/socket (2 x HanBrid)	PROFIBUS FastConnect bus connector	5	3RK1911-1AF22		1	1 unit
• Cu/Cu, for looping through in the field	Pin/socket (2 x HanBrid)	PROFIBUS FastConnect bus connector	5	3RK1911-1AF32		1	1 unit
Active (refresher)							
• Cu/Cu, for feeding into the field	Socket/socket (2 x HanBrid)	9-pole Sub D socket	5	3RK1911-1AJ22		1	1 unit
• Cu/Cu, for looping through in the field	Pin/socket (2 x HanBrid)	9-pole Sub D socket	5	3RK1911-1AJ32		1	1 unit
• Cu/Cu, for feeding into the field	Socket/socket (2 x M12)	9-pole Sub D socket	5	3RK1911-1AK22		1	1 unit

Version	SD	Article No.	Price per PU	PU (UNIT, SET, M)	PS*
	d				

Accessories



Sealing caps for HanBrid
Protective cover for bus and power supply connection (pack of 10)

6ES7194-1JB10-0XA0

1	6ES7194-1JB10-0XA0	1	10 units
---	---------------------------	---	----------

PROFIBUS ECOFAST hybrid cables, [see Catalog ST 70 or Industry Mall](#).

