

contents

Section Overview	11/2 – 11/3		
Temperature Monitoring Relays			
3RS2 NEW			
Overview	11/4 – 11/5		
Catalog number builder	11/6		
Technical specifications	11/7 – 11/11		
Selection and ordering data	11/12		
Accessories	11/13		
Thermistor Motor Protection			
Overview	11/15		
Benefits and Application	11/16		
Technical specifications	11/17 – 11/18		
Function Diagrams	11/19		
Technical Data	11/20 – 11/21		
3RN2 Selection and ordering data	11/22		
Accessories	11/23		
Timing Relays			
General Data	11/24		
3RP25 Timing Relays, 17.5 mm and 22.5 mm			
Overview	11/25 – 11/26		
Technical specifications	11/28		
Circuit diagrams	11/29 – 11/33		
Functions	11/34 – 11/39		
Selection and ordering data	11/40		
Accessories	11/41		
3RP20 Timing Relays, 45mm			
Overview	11/42		
Technical specifications	11/43		
Functions	11/44 11/45		
Selection and ordering data	11/46		
Accessories	11/47		
7PV15 Timing Relays, 17.5mm			
Overview	11/48		
Technical specifications	11/49		
Circuit diagrams	11/49 – 11/50		
Functions	11/51 – 11/52		
Selection and ordering data	11/53		
Monitoring Relays for Stand-alone Installation			
3UG45, 3UG46 General data	11/54 – 11/55		
Line monitoring	11/56 – 11/60		
Voltage monitoring	11/61 – 11/63		
Current monitoring	11/64 – 11/65		
Power factor and active current monitoring	11/66 – 11/68		
Residual-current monitoring relays	11/69 – 11/70		
3UL23 residual-current transformers	11/71		
Insulation monitoring			
General data	11/72 – 11/73		
For ungrounded AC networks	11/74 – 11/75		
For ungrounded DC and AC networks	11/76 – 11/80		
Level monitoring sensors	11/81		
Speed monitoring	11/82 – 11/84		
Accessories	11/85		
Monitoring Relays For Stand-alone Installation for IO-Link			
3UG48 General data	11/86 – 11/88		
Line monitoring	11/89 – 11/91		
Voltage monitoring	11/92 – 11/94		
Current monitoring	11/95 – 11/97		
Power factor and active current monitoring	11/98 – 11/101		
Residual-current monitoring relays	11/102 – 11/104		
Speed monitoring	11/105 – 11/107		
Accessories	11/108		
DC Load Monitoring Relays			
3UG546 NEW			
Overview	11/109		
Technical data	11/110 – 11/112		
Selection and ordering data	11/113		
Accessories	11/113		
Coupling Relays – Narrow Design			
3RQ3 Overview	11/114		
Benefits	11/115		
Technical specifications	11/116 – 11/117		
Circuit diagrams	11/118		
Selection and ordering data	11/119 – 11/121		
Accessories			
Coupling Relays with Industrial Enclosure			
3RQ2 Overview	11/122		
Technical specifications	11/123		
Selection and ordering data	11/124		
Accessories	11/124		
Signal Converters/Interface Converters			
3RS70 Overview	11/126		
Technical specifications	11/127 – 11/129		
Circuit diagrams	11/130		
Selection and Ordering	11/131		
Accessories	11/132		
Power Relays			
3TG10			
Overview	11/133		
Selection and ordering data	11/133		
Technical specifications	11/134 – 11/135		
Accessories, Circuit Diagrams, Dimensions	11/136		
Plug-in Relays			
3TX71			
Selection and ordering data	11/137 – 11/140		
Technical specifications	11/141 – 11/142		
Circuit diagrams	11/143 – 11/145		
Dimensions	11/146 – 11/152		
LZS			
Selection and ordering data	11/153 – 11/157		
Technical specifications	11/158 – 11/160		

contents

3RS2 temperature monitoring relays



3RS10/3RS20 temperature monitoring relay for RTD or Thermocouple Page

- Selection and ordering data**
- Overview 11/4 – 11/5
 - Selection and Ordering 11/12
 - Accessories 11/13

- Catalog number builder 11/6
- Technical specifications 11/7 – 11/11

3RN2 thermistor motor protection



3RN20 thermistor motor protection for PTC temperature detectors Page

- Selection and ordering data**
- Overview 11/15
 - Screw and Spring-type connection 11/16
 - Accessories 11/17

- Technical data 11/17
- Function diagrams 11/18
- Functions 11/19
- Circuit diagrams 11/20
- Dimension drawings 11/22

3RP20 timing



3RP20 timing relays Page

- Selection and ordering data**
- Overview 11/42
 - Screw and Spring-type connection 11/46

- Technical data 11/43
- Function diagrams 11/44

Timing Relays



3RP25 timing relays Page

- Selection and ordering data**
- Overview 11/25
 - Screw and Spring-type connection 11/40

- Technical data 11/28
- Circuit diagrams 11/29
- Function diagrams 11/34



7PV solid-state relay Page

- Selection and ordering data**
- Screw connection 11/29
 - Accessories 11/29

- Technical data 11/29
- Dimension drawings 11/29



3RA28 and 3RT19 time delay blocks for mounting on 3RT contactors

- Selection and ordering data**
- See Section 2, page 2/70

contents

3UG monitoring relays



For electrical and mechanical quantities, including connection to IO-Link

Page

Catalog Numbering system

- 3UG45, 3UG46 11/54
- 3UG48 11/87

3UG45, 3UG46	11/54 – 11/85
3UG48	11/86 – 11/108



DC Load Monitor with Profinet

Page

Selection and ordering data

- 3UG546 Selection Data 11/113

Overview	11/109
Technical data	11/110 – 11/112

Coupling relays and interfaces



3RQ3 slim design
3RQ2 standard width

Page

Selection and ordering data

- 3RQ3 Selection Data 11/119
- 3RQ2 Selection Data 11/124

Overview	11/114
Technical data	11/116
Accessories	11/122

Coupling relays and interfaces



3RS70 signal converter

Page

Selection and ordering data

- Screw and Spring-type connection 11/131

Overview	11/126
Technical data	11/127
Circuit diagrams	11/130



3TG10 power relay,
20A max. resistance load pole

Page

Selection and ordering data

- AC and DC operation, hum-free With screw connection or tab connector 11/133
- Accessories 11/136

Application	11/133
Technical data	11/134
Circuit diagrams	11/136
Position of terminals	11/136
Dimension drawings	11/136



3TX71 and LZ series

Page

Selection and ordering data

- AC and DC operation 11/137

Technical data	11/141
Circuit diagrams	11/143
Dimension drawings	11/146

Overview

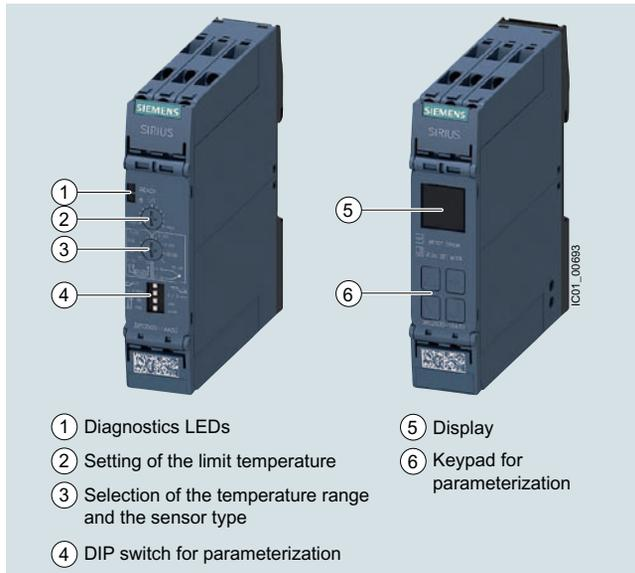

- ① Diagnostics LEDs
- ② Setting of the limit temperature
- ③ Selection of the temperature range and the sensor type
- ④ DIP switch for parameterization
- ⑤ Display
- ⑥ Keypad for parameterization

SIRIUS 3RS2 temperature monitoring relays

More information

Homepage, see www.usa.siemens.com/relays
 Industry Mall, see www.siemens.com/product?3RS2
 Conversion tool for article numbers, see www.siemens.com/sirius/conversion-tool

The 3RS2 temperature monitoring relays can be used to measure temperatures in solid, liquid and gas media. The temperature is acquired by means of sensors in the medium, evaluated by the device and monitored for overshoot, undershoot or location within a specified range (window function).

The family comprises an analog multi-function device which can be set using DIP switches and potentiometers, and digital devices which can be parameterized via an intuitive LCD display. The digital device is also available as a version with IO-Link.

All 3RS26 digital devices, including the 3RS28 versions with IO-Link, have safety certification according to IEC 61508/62061 or ISO 13849 up to SIL 1/PL c as well as EN 14597 for heat generating systems and EN 50156 for burners.

Furthermore, the functionality of the 3RS26/3RS28 digital devices can be expanded using a 3RS29 sensor expansion module with two additional resistance sensors, e.g. for monitoring three-phase motors or transformers.

The 3RS29 sensor expansion module also features an additional relay for outputting the sensor status, and an additional analog input 4 to 20 mA. This analog input allows ATEX applications to be implemented when using an intrinsically safe temperature sensor or other appropriate type of protection. The 3RS29 is connected wirelessly via a SIL 1-certified infrared communication interface.

Notes:

The SIRIUS 3RS2 temperature monitoring relays fully replace the 3RS1 predecessor. The large number of 3RS1 analog devices can simply be replaced with the new 3RS25 analog multi-function device. The reduced variety of order numbers means the successors can be selected quickly and easily.

The 3RS2 digital devices fully supersede the functionality of the 3RS1 predecessor in a single device type that is now able to use resistance sensors and thermocouples – all at half the width of 22.5 mm instead of 45 mm.

Analog multi-function devices



SIRIUS 3RS25 analog multi-function device

The analog multi-function device is parameterized using DIP switches and potentiometers. The device can be used to monitor a sensor with a limit value for overshoot or undershoot. The most common temperature ranges with Pt100 resistance sensors or type J or K thermocouples can be used for this purpose. This device can therefore also be used as a compact, easy-to-adjust two-point controller. The relay CO contact output enables loads to be switched directly. The NC contact can optionally be used as a signaling contact.

Digital devices (1 sensor)



SIRIUS 3RS26 digital device (1 sensor) with 3RS29 sensor expansion module

The SIRIUS 3RS26 digital device with display enables sensors with two limit values to be monitored using all common resistance sensors and thermocouples.

The additional limit value means that, in addition to overshoot and undershoot, an additional warning value can be output to the relay outputs. Alternatively, the second monitoring value can also be used to implement range monitoring. The digital devices can thus also be used as compact two or three-point controllers, with Manual or Remote RESET.

Thanks to safety certification, this device can be used in a wide range of applications.

The functionality of the SIRIUS 3RS26 and 3RS28 digital devices can be expanded wirelessly with the sensor expansion module via a SIL 1-certified infrared communication interface. This combination then features three sensors and is designed for monitoring large three-phase motors and transformers. It goes without saying that the additional sensors can also be used for other applications.

Digital devices (1 sensor) for IO-Link



SIRIUS 3RS28 digital device (1 sensor) for IO-Link with 3RS29 sensor expansion module

The 3RS28 digital temperature monitoring relays for IO-Link feature an IO-Link communication interface in addition to a display. They include all functions of the 3RS26 digital device and can also be operated on L+/L- as a stand-alone installation with 24 V DC.

Note:

The IO-Link devices can be reset on the display or via IO-Link.

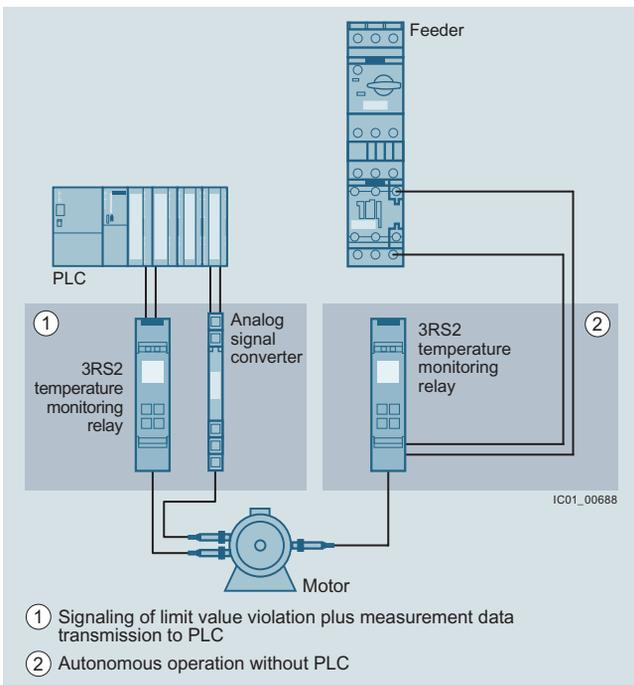

Conventional temperature monitoring relays

Notes:

Devices required for communication via IO-Link:

- Any controller that supports IO-Link (e.g. ET 200SP with CPU or S7-1200).
- IO-Link master (e.g. CM 4xIO-Link for SIMATIC ET 200SP).

Each monitoring relay requires an IO-Link channel.

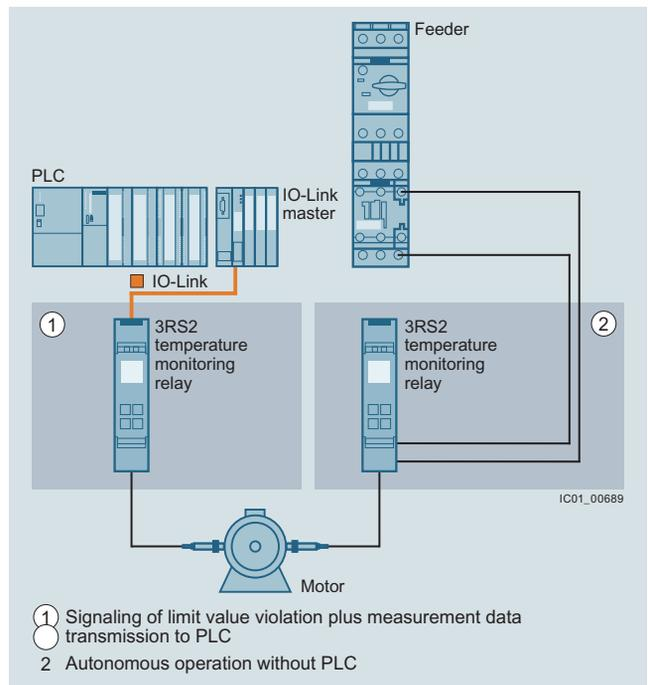

Temperature monitoring relays for IO-Link

Notes on security

In order to protect plants, systems, machines and networks against cyber threats, it is necessary to implement – and continuously maintain – a holistic, state-of-the-art industrial security concept. Siemens products and solutions represent only one component of such a concept.

For more information about the subject of Industrial Security, see www.usa.siemens.com/industrialsecurity

Article No. scheme

Product versions		Article number									
Temperature monitoring relays		3RS2	<input type="checkbox"/> 0	<input type="checkbox"/> 0	-	<input type="checkbox"/> <input type="checkbox"/> <input type="checkbox"/> <input type="checkbox"/> 0	<input type="checkbox"/> 0				
Device type	e.g. 5 = analogically adjustable	<input type="checkbox"/>									
Connection type	Screw terminals					1					
	Spring-loaded terminals (push-in)					2					
Number of CO contacts	e.g. A = 1 CO contact, B = 2 CO contacts					<input type="checkbox"/>					
Rated control supply voltage	A = 24 V AC/DC, W = 24 ... 240 V AC/DC						<input type="checkbox"/>				
Type of rated control supply voltage	3 = AC/DC, 4 = DC						<input type="checkbox"/>				
Example		3RS2	5	0	0	-	1	A	A	3	0

Note:

The Article No. scheme shows an overview of product versions for better understanding of the logic behind the article numbers. For your orders, please use the article numbers quoted in the selection and ordering data.

Benefits

- Customary screw and spring-loaded terminals for quick and reliable wiring
- Reduced space requirement in the control cabinet thanks to a consistent width of 22.5 mm
- Easy parameterization thanks to new display and intuitive operating concept
- Reduced stock keeping and logistics thanks to heavily reduced device variance
- Cost savings thanks to additional scalable functionality with integrated infrared interface
- Communication via IO-Link for 3RS28
- Global applicability and exportability thanks to compliance with international standards and certifications
- Problem-free use in a wide range of applications thanks to Safety bundle with certification according to SIL 1/PL c, ATEX, EN 14597 for heat generating systems and EN 50156 for burners
- All versions with removable terminals
- All versions with screw or spring-loaded terminals with push-in functionality

Application

The SIRIUS 3RS2 temperature monitoring relays can be used in almost any application in which temperature overshoot or undershoot is not permitted, e.g. in the monitoring of set temperature limits and the output of alarm messages for:

- Simple and compact two-point control
- Motor and system protection
- Control cabinet temperature monitoring
- Freeze monitoring
- Temperature limits for process variables e.g. in the packaging industry or electroplating
- Controlling equipment and machines such as heating, climate and ventilation systems, solar collectors, heat pumps or warm water supplies
- Motor, bearing and gear oil monitoring
- Monitoring of coolants

Additionally for digital devices

- Simple and compact two or three-point control
- Burner acc. to EN 50156
- Temperature monitors or temperature limiters¹⁾ according to EN 14597
- ATEX explosion protection according to EN 50495

¹⁾ A 3RS29 sensor expansion module with an additional sensor is required for the function as a temperature limiter.

Technical specifications

More information

Technical specifications, see <https://support.industry.siemens.com/cs/ww/en/ps/25719/td>

Equipment Manual and internal circuit diagrams, see <https://support.industry.siemens.com/cs/ww/en/ps/25719/man>

FAQs, see <https://support.industry.siemens.com/cs/ww/en/ps/25719/faq>

Connection of resistance-type thermometers

Two-wire measurement

When two-wire temperature sensors are used, the resistances of the sensor and wiring are added. The resulting systematic error must be taken into account when the evaluation unit is calibrated. A jumper must be clamped between terminals T2 and T3 for this purpose.

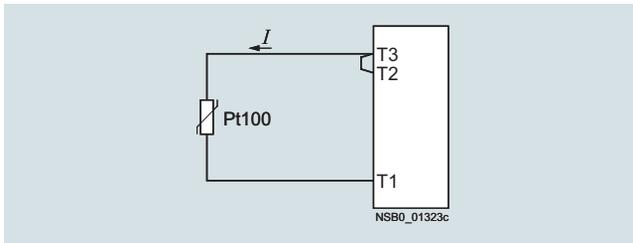

Wiring errors

The errors that are generated by the wiring comprise approximately 2.5 K/Ω. If the resistance of the cable is not known and cannot be measured, the wiring errors can also be estimated using the following table.

Temperature drift dependent on the length and cross-section of the cable with Pt100 sensors and an ambient temperature of 20 °C, in K:

Cable length in m	Cross-section mm ²			
	0.5	0.75	1	1.5
	Temperature drift in K:			
0	0	0	0	0
10	1.8	1.2	0.9	0.6
25	4.5	3.0	2.3	1.5
50	9.0	6.0	4.5	3.0
75	13.6	9.0	6.8	4.5
100	18.1	12.1	9.0	6.0
200	36.3	24.2	18.1	12.1
500	91.6	60.8	45.5	30.2

Example: On a Pt100 sensor with a cable length of 10 m and a conductor cross-section of 1 mm² the temperature drift equals 0.9 K.

Three-wire measurement

To minimize the effects of the line resistances, a three-wire circuit is often used. Using the additional cable, two measuring circuits can be formed of which one is used as a reference. The evaluation unit can then automatically calculate the line resistance and take it into account.

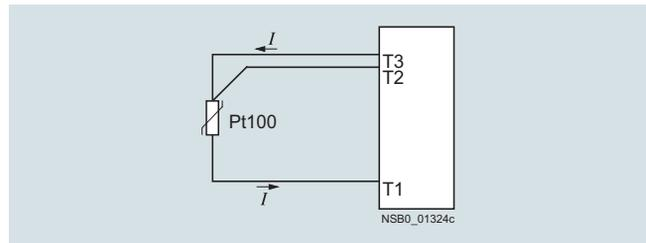

Connection of thermocouples

Based on the thermo-electrical effect, a differential temperature measurement will be performed between the measuring point and the evaluation unit.

This principle assumes that the evaluation unit knows the temperature at the clamping point (T2). For this reason, the 3RS2 temperature monitoring relays have an integral compensator that determines this comparison temperature and builds it into the measurement. The thermal sensors and cables must therefore be insulated.

The absolute temperature is therefore calculated from the ambient temperature of the evaluation unit and the temperature difference measured by the thermocouple.

Temperature detection is therefore possible (T1) without needing to know the precise ambient temperature of the clamping point at the evaluation unit (T2).

The connecting cable is only permitted to be extended using connecting leads that are made from the same material as the thermocouple. If a different type of conductor is used, an error will result in the measurement.

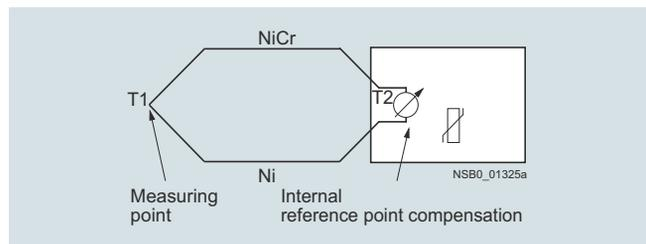

Principle of operation

Once the temperature has reached the set threshold value ϑ_1 , the K1 output relay changes its switching state as soon as the set time t has elapsed (K2 responds in the same manner to ϑ_2). The delay time can only be adjusted with digital units (on analog units $t = 0$).

When Auto RESET (AUTO RST) is set, the relays return to their original state as soon as the temperature reaches the set hysteresis value.

The memory function (MEMORY) allows the status to be saved even in the event of a power failure.

3RS25 analog multi-function devices

Temperature overshoot

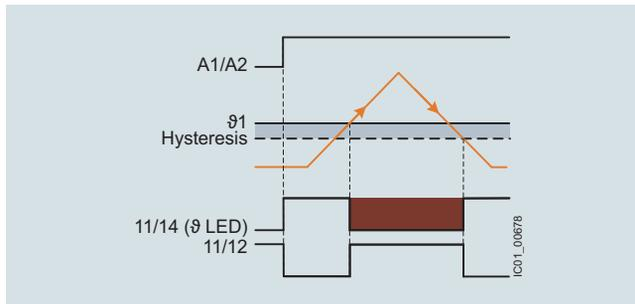

Temperature undershoot

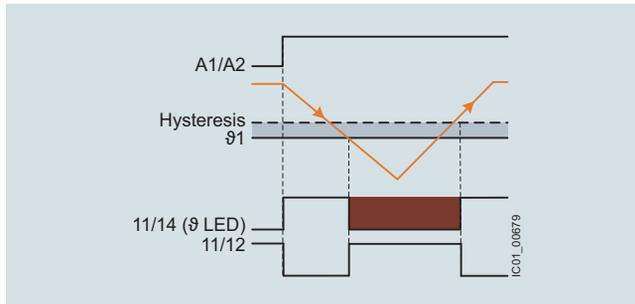

3RS26, 3RS28 digital devices (1 sensor) with Safety function

Temperature monitor according to EN 14597

Temperature overshoot

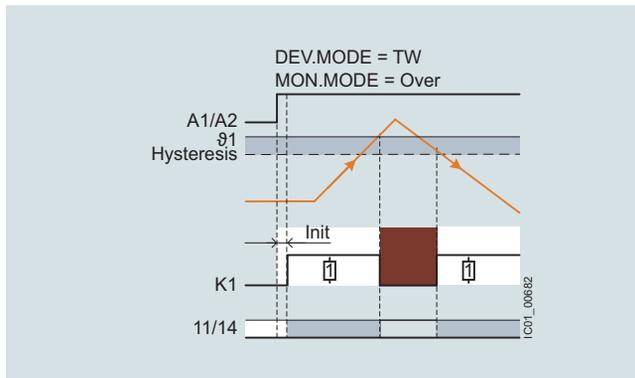

Temperature undershoot

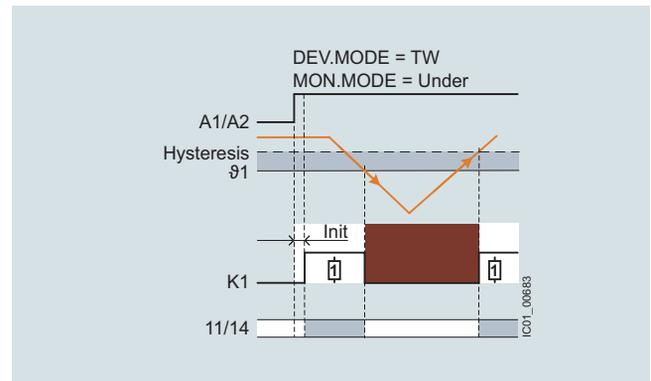

Temperature limiter according to EN 14597/ATEX

Temperature overshoot

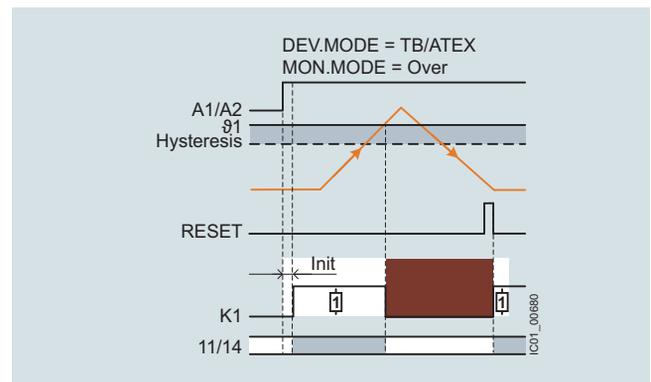

Temperature undershoot

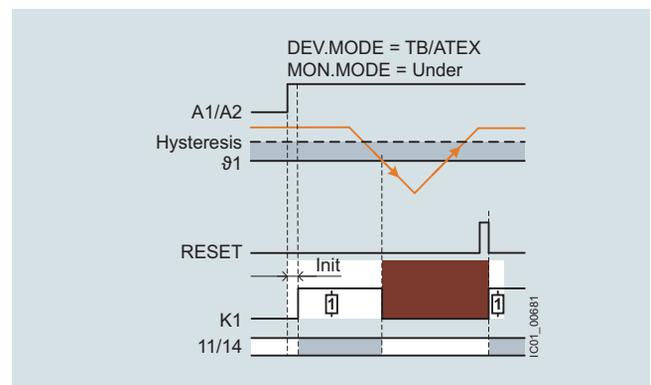

Relays

SIRIUS 3RS2 temperature monitoring relays **NEW**

3RS26, 3RS28 digital devices (1 sensor)

Temperature overshoot

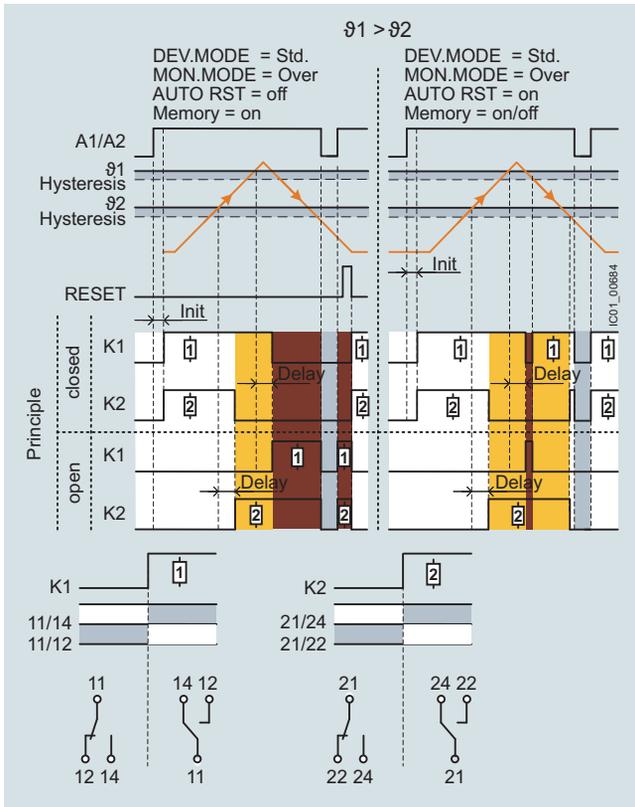

Range monitoring

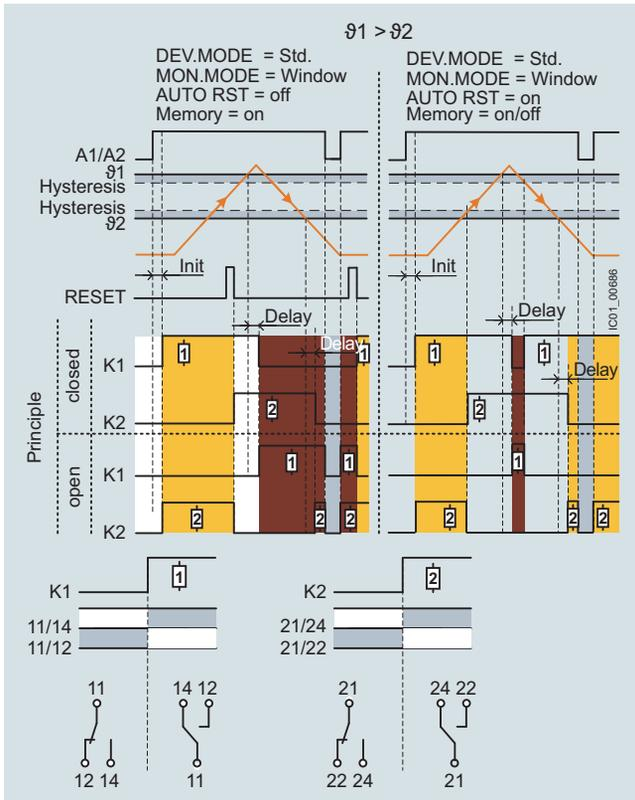

Temperature undershoot

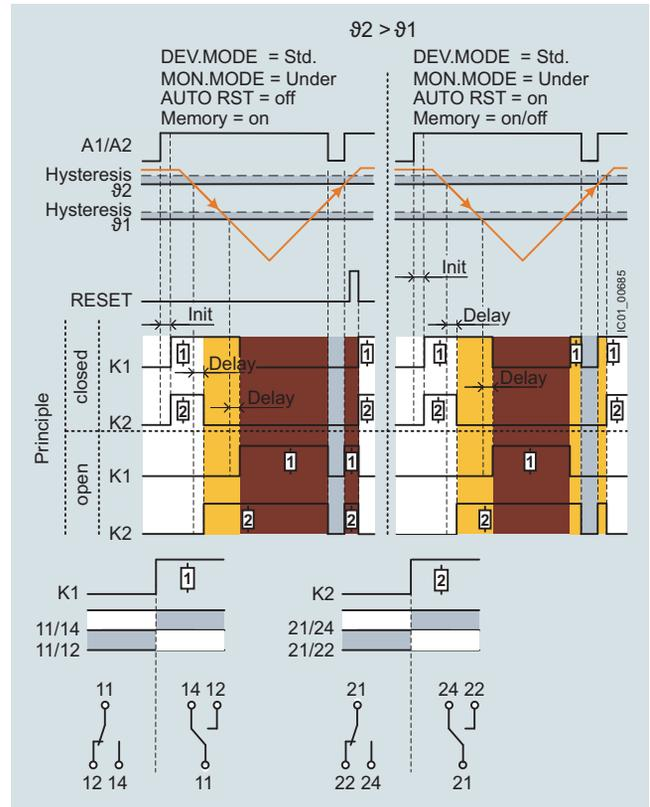

Range monitoring

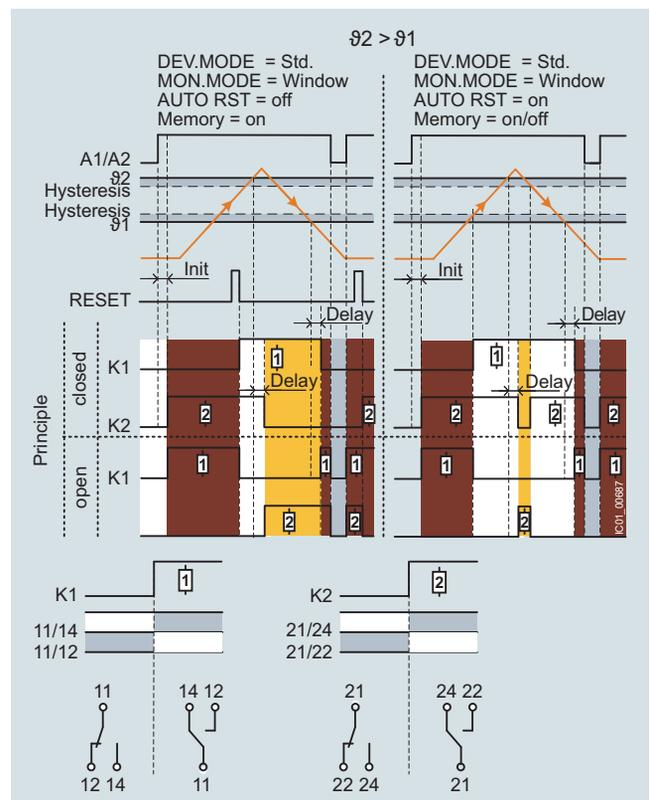

Characteristic curves

For resistance sensors

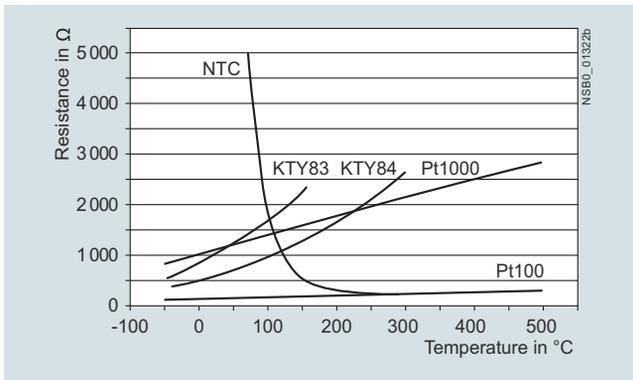

Characteristic curves for resistance sensors

The short-circuit and open-circuit detection as well as the measuring range is limited, depending on the sensor type.

Measuring ranges and switch position for analog devices in °C for Pt100 resistance sensor

Measuring range in °C	Switch position in °C										
	min.					1/2					max.
0 ... +100	0	10	20	30	40	50	60	70	80	90	100
0 ... +200	0	20	40	60	80	100	120	140	160	180	200
-50 ... +50	-50	-40	-30	-20	-10	0	10	20	30	40	50

Measuring ranges for digital devices in °C for resistance sensor

Sensor type	Short circuit	Open circuit	3RS26, 3RS28 Measuring range in °C	3RS26, 3RS28 Measuring range in °F
Pt100	✓	✓	-50 ... +750	-58 ... +1 382
Pt1000	✓	✓	-50 ... +500	-58 ... +932
KTY83-110	✓	✓	-50 ... +175	-58 ... +347
KTY84	✓	✓	-40 ... +300	-40 ... +572
NTC ¹⁾	✓	--	+80 ... +160	+176 ... +320

- ✓ Detection possible
- Detection not possible

¹⁾ NTC type: B57227-K333-A1 (100 °C: 1.8 kΩ; 25 °C: 32.762 kΩ).

For thermocouples

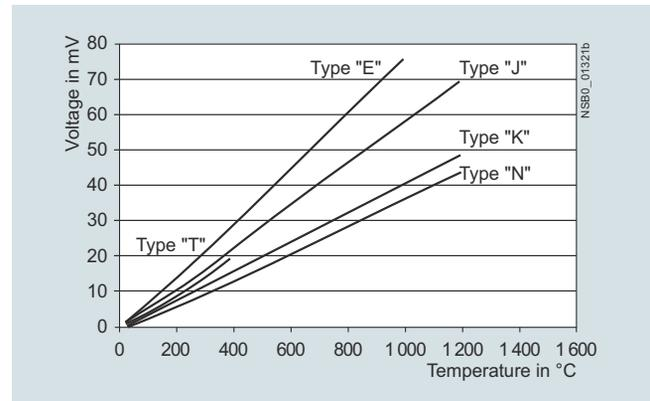

Characteristic curves for thermocouples J, K, T, E, N

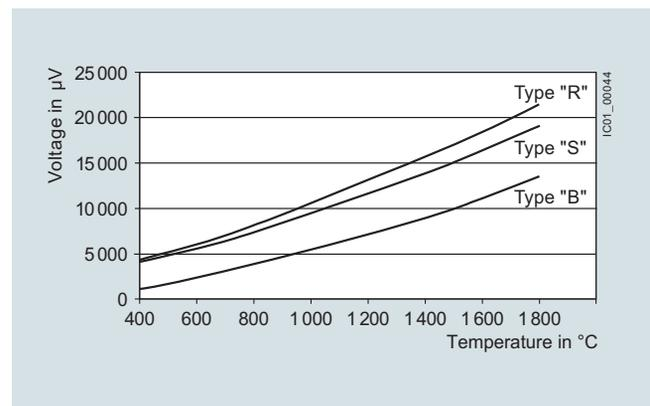

Characteristic curves for thermocouples S, R and B

Measuring ranges and switch position for analog devices in °C for thermocouple types J, K

Measuring range in °C	Switch position in °C										
	min.					1/2					max.
0 ... +200	0	20	40	60	80	100	120	140	160	180	200
0 ... +600	0	60	120	180	240	300	360	420	480	540	600
+500 ... +1 000	500	550	600	650	700	750	800	850	900	950	1 000

Measuring ranges for digital devices in °C/°F for thermocouples

Sensor type	Short circuit	Open circuit	3RS26, 3RS28 Measuring range in °C	3RS26, 3RS28 Measuring range in °F
J	--	✓	-99 ... +1 200	-146.2 ... +2 192
K	--	✓	-99 ... +1 350	-146.2 ... +2 462
T	--	✓	-99 ... +400	-146.2 ... +752
E	--	✓	-99 ... +999	-146.2 ... +1 830.2
N	--	✓	-99 ... +1 300	-146.2 ... +2 372
S	--	✓	0 ... +1 750	+32 ... +3 182
R	--	✓	0 ... +1 750	+32 ... +3 182
B	--	✓	+400 ... +1 800	+752 ... +3 272

- ✓ Detection possible
- Detection not possible

Relays

SIRIUS 3RS2 temperature monitoring relays **NEW**

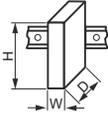
Type		3RS25	3RS26 3RS28	3RS29
General technical specifications				
Dimensions (W x H x D)		mm	22.5 x 100 x 90	
Permissible ambient temperature		°C	-25 ... +60	
• During operation		°C	-40 ... +85	
• During transport		°C	-40 ... +85	
• During storage		°C	-40 ... +85	
Degree of protection			20	
Mounting position			Any	
Type of mounting			Screw fixing and snap-on mounting onto 35 mm standard mounting rail	
Connection type			 Screw terminals	
• Tightening torque	Nm	0.6 ... 0.8		
• Solid	mm ²	1 x (0.5 ... 4), 2 x (0.5 ... 2.5)		
• Finely stranded with end sleeve	mm ²	1 x (0.5 ... 4), 2 x (0.5 ... 2.5)		
• AWG cables, solid	AWG	1 x (20 ... 12), 2 x (20 ... 14)		
Connection type			 Spring-loaded terminals (push-in)	
• Solid	mm ²	1 x (0.5 ... 4)		
• Finely stranded without end sleeve	mm ²	1 x (0.5 ... 4)		
• Finely stranded with end sleeve	mm ²	1 x (0.5 ... 2.5)		
• AWG cables, solid or stranded	AWG	1 x (20 ... 12)		
Auxiliary circuit				
Type of voltage			AC/DC	
Operating range factor of the control supply voltage, rated value			0.85 ... 1.1	
• At AC at 50 Hz			0.85 ... 1.1	
• At AC at 60 Hz			0.85 ... 1.1	
• At DC			0.85 ... 1.1	
Operating frequency, rated value	Hz	50 ... 60		
Number of measuring circuits		1		3
Number of CO contacts for auxiliary contacts		1	2	0
Product function				
• Removable terminal for auxiliary and control circuit		Yes		
• Auto RESET		Yes		--
• Error memory		--	Yes	
• External RESET		--	Yes	
ATEX				
Certificate of suitability				
• Relative to ATEX		--	Yes, with 3RS29 sensor expansion module	Yes, with 3RS26/3RS28 digital device
Safety integrity level (SIL) according to IEC 61508		--	1	
Performance level (PL) according to EN ISO 13849-1		--	c	

Selection and ordering data

Type of sensor/ connectable	Rated control supply voltage U_s 50/60 Hz AC	Suitability for use	SD	Screw terminals	SD	Spring-loaded terminals (push-in)	
	V	d		Article No.	Price per PU	Article No.	Price per PU

Temperature monitoring relays

**Analog multi-function device, 1 sensor,
1 threshold value**



3RS2500-1AA30

Resistance sensors:	24 AC/DC	--	10
Pt100	24 ... 240 AC/DC	--	10
Thermocouples:			
Type J, K			

3RS2500-1AA30	10	3RS2500-2AA30
3RS2500-1AW30	10	3RS2500-2AW30

Digital device, 1 sensor, 2 threshold values



3RS2600-1BA30

Resistance sensors:	24 AC/DC	--	10
Pt100, Pt1000, KTY83-110, KTY84, NTC	24 ... 240 AC/DC	--	10
Thermocouples:			
Type J, K, T, E, N, S, R, B			

3RS2600-1BA30	10	3RS2600-2BA30
3RS2600-1BW30	10	3RS2600-2BW30

Digital device for IO-Link, 1 sensor, 2 threshold values



3RS2800-1BA40

Resistance sensors:	24 DC	--	10
Pt100, Pt1000, KTY83-110, KTY84, NTC			
Thermocouples:			
Type J, K, T, E, N, S, R, B			

3RS2800-1BA40	10	3RS2800-2BA40
----------------------	----	----------------------

Sensor expansion modules

**2 additional resistance sensors, analog input
4 ... 20 mA, ATEX via analog input, status relay**



3RS2900-1AA30

Resistance sensors:	24 AC/DC	For 3RS26/	10
Pt100, Pt1000, KTY83-110, KTY84, NTC	24 ... 240 AC/DC	3RS28 digital devices	10

3RS2900-1AA30	10	3RS2900-2AA30
3RS2900-1AW30	10	3RS2900-2AW30

For accessories, see page 11/13.

Accessories

Version	SD	Article No.	Price per PU	PU (UNIT, SET, M)	PS*
Terminals for SIRIUS devices in the industrial standard mounting rail enclosure					
 3ZY1122-1BA00	Removable terminals • 2-pole, up to 1 x 4 mm ² or 2 x 2.5 mm ² • 2-pole, up to 1 x 4 mm ² or 2 x 1.5 mm ²	Screw terminals  3ZY1122-1BA00		1	6 units
		Spring-loaded terminals (push-in)  3ZY1122-2BA00		1	6 units
Accessories for enclosures					
 3ZY1311-0AA00	Push-in lugs For wall mounting	2	3ZY1311-0AA00	1	10 units
 3ZY1440-1AA00	Coding pins For removable terminals of SIRIUS devices in the industrial standard mounting rail enclosure; enable the mechanical coding of terminals	2	3ZY1440-1AA00	1	12 units
 3ZY1450-1AB00	Hinged cover Replacement cover, without terminal labeling, titanium gray • 22.5 mm wide	2	3ZY1450-1AB00	1	5 units
Tools for opening spring-loaded terminals					
 3RA2908-1A	Screwdrivers For all SIRIUS devices with spring-loaded terminals Length approx. 200 mm, 3.0 mm x 0.5 mm, titanium gray/black, partially insulated	2	Spring-loaded terminals (push-in)  3RA2908-1A	1	1 unit

Relays

SIRIUS 3RS14, 3RS15 Temperature Monitoring Relays for IO-Link

General data

Overview



SIRIUS 3RS14, 3RS15 temperature monitoring relay

More information

Homepage, see www.siemens.com/relays
 Industry Mall, see www.siemens.com/product?3RS14

The temperature monitoring relays for IO-Link are used to measure temperatures in solid, liquid and gas media.

The temperatures are acquired by means of sensors in the medium, evaluated by the device and monitored up to two limit values for overshooting or undershooting a working range (window function).

In addition to warnings and disconnection in case of temperature deviations, the devices can also be used as a temperature controller (one-point, two-point or three-point control).

The devices differ from one another in terms of the type and number of connectable temperature sensors.

- 3RS14: Connection for resistance sensor
- 3RS15: Connection for thermocouples

Function	Temperature monitoring relays		
	3RS1440	3RS1441	3RS1540
Connectable sensor type			
Number of sensors monitored	1	3	1
Resistance sensor	✓	✓	--
Thermocouples	--	--	✓
Temperature monitoring			
Temperature monitoring – overshoot	✓	✓	✓
Temperature monitoring – undershoot	✓	✓	✓
Number of adjustable limit values	2	2	2

- ✓ Function supported
- Function not supported

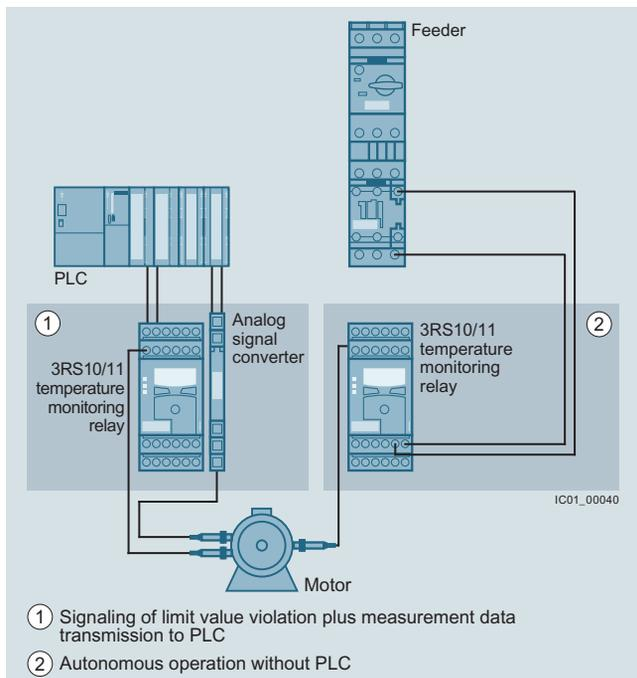

Conventional temperature monitoring relays

Notes:

Devices required for the communication via IO-Link:

- Any controller that supports IO-Link (e.g. ET 200SP with CPU or S7-1200), see [Catalog ST 70](#).

Each monitoring relay requires an IO-Link channel.

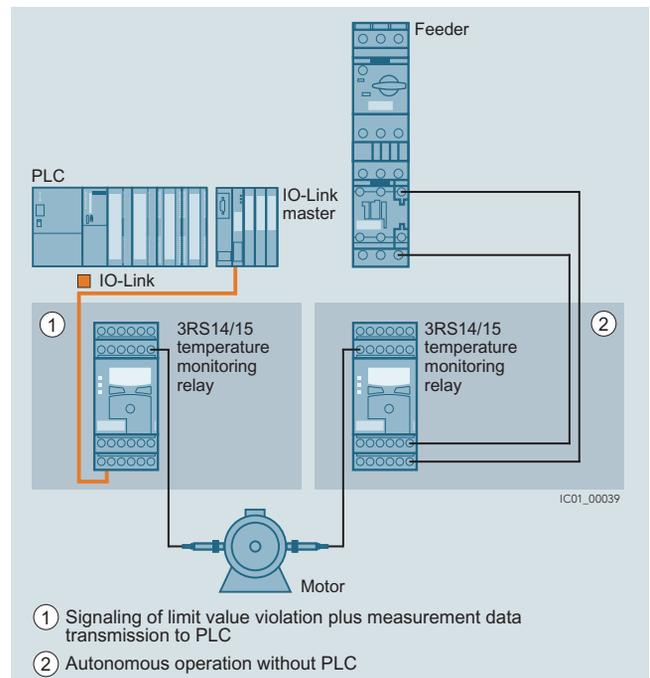

Temperature monitoring relays for IO-Link

Notes on security

In order to protect plants, systems, machines and networks against cyber threats, it is necessary to implement – and continuously maintain – a holistic, state-of-the-art industrial security concept. Siemens products and solutions represent only one component of such a concept.

For more information on Industrial Security, see www.usa.siemens.com/industrialsecurity.

Overview



SIRIUS 3RN2 thermistor motor protection

More information

Homepage, see www.usa.siemens.com/relays
 Industry Mall, see www.siemens.com/product?3RN2
 For the conversion tool, e.g. from 3RN1 to 3RN2, see www.siemens.com/sirius/conversion-tool

Thermistor motor protection devices are used for direct monitoring of the motor winding temperature. For this purpose, the motors are equipped with temperature-dependent resistors (PTC) that are directly installed in the motor winding and abruptly change their resistance at their temperature limit.

Versions

SIRIUS 3RN2 thermistor motor protection relays are available in the following versions:

- 3RN2000 compact evaluation unit
- 3RN2010 compact/standard evaluation unit
- 3RN2012-.BW31 bistable evaluation unit
- 3RN2011, 3RN2012-...30, 3RN2013 standard evaluation unit with ATEX approval
- 3RN2023 evaluation unit with ATEX approval and 2 sensor circuits for warning and disconnection

They comply with

- IEC 60947-8. Low-voltage switchgear and controlgear – Part 8: "Control units for built-in thermal protection (PTC) for rotating electrical machines"
- IEC 61000-6-2, IEC 61000-6-4. "Electromagnetic compatibility for industrial-process measurement and control equipment"

The 3RN2 thermistor motor protection relays with ATEX approval fulfill SIL1 in compliance with EN 50495.

The terminals of the auxiliary contacts are designated in accordance with EN 60947-1.

3RN2 evaluation units are suitable for snap-on mounting onto TH 35 standard mounting rails according to IEC 60715 or for screw fixing using an adapter (accessory).

Article No. scheme

Product versions		Article number								
Thermistor motor protection relay with PTC sensor, type A		3RN20 □ □ - □ □ □ □ □								
Number and version of the sensor circuits	1 sensor circuit, supply voltage = root voltage	0								
	1 sensor circuit	1								
	2 sensor circuits for warning and disconnection	2								
RESET	Auto RESET	0								
	Manual RESET, with open-circuit and short-circuit detection	1								
	Manual/Auto/Remote RESET, non-volatile, with open-circuit and short-circuit detection	2								
	Manual/Auto/Remote RESET, non-volatile, with open-circuit and short-circuit detection, with protective separation	3								
Connection method	Screw terminals		1							
	Spring-type terminals (push-in)		2							
Auxiliary switches	1 CO			A						
	2 CO			B						
	1 NO + 1 NC			C						
	1 NO + 1 CO			D						
	2 CO, hard gold-plated			G						
Rated control supply voltage	24 V AC/DC			A	3					
	24 ... 240 V AC/DC			W	3					
Response to failure	Monostable					0				
	Bistable					1				
Example		3RN20	0	0	-	1	A	A	3	0

Note:

The Article No. scheme is presented here merely for information purposes and for better understanding of the logic behind the article numbers.

For your orders, please use the article numbers quoted in the selection and ordering data.

Benefits

- Thanks to direct motor protection, overdimensioning of the motors is not necessary
- No settings on the device are necessary
- Semiconductor compatible output thanks to versions with hard gold-plated contacts
- Rapid error diagnosis thanks to versions that indicate open and short circuits in the sensor circuit
- All versions with removable terminals
- All versions with screw or spring-type terminals with push-in functionality

Application

Direct motor protection through temperature monitoring of the motor winding offers 100% motor protection even under the most difficult ambient conditions, without the need to make adjustments on the device. Versions with hard gold-plated contacts ensure, in addition, a high switching reliability that is even higher than an electronic control.

Direct motor protection

- At increased ambient temperatures
- When switching frequency is too high
- When start up and braking procedures are too long

ATEX approval for operation in areas subject to explosion hazard

The SIRIUS 3RN2011, 3RN2012-...30, 3RN2013 and 3RN2023 thermistor motor protection relays for PTC sensors are certified according to ATEX Ex II (2) G and D for environments with explosive gas or dust loads.

Motor protection using current- and temperature-dependent protective devices

IEC 60204 stipulates that motors must be protected from overheating at a rating of 0.5 kW and higher. The protection can take the form of overload protection, overtemperature protection or current limiting.

For motors with frequent starting and braking and in environments where cooling may be impaired (e.g. by dust), it is recommended to use the overtemperature protection option in the form of a protective device coordinated with this mode of operation. A good choice in this case is the use of 3RN2 thermistor motor protection devices.

On rotor-critical motors, overtemperature detection in the stator windings can lead to delayed and hence inadequate protection. In this case the standards stipulate additional protection, e.g. by means of an overload relay.

This combination of thermistor motor protection and an overload relay is recommended for full motor protection in case of frequent starting and braking of motors, irregular intermittent duty or excessive switching frequency. To prevent premature tripping of the overload relay in such operating conditions, a higher setting than that normally required for the operational current is chosen. The overload relay then performs stall protection, and the 3RN2 thermistor motor protection relay monitors the temperature of the motor windings.

Application	Motor protection		
	Only current-dependent, e.g. with overload relay	Temperature-dependent only, e.g. with thermistor motor protection relay	Current- and temperature-dependent
Motor protection in case of			
Overloading in uninterrupted duty	✓	✓	✓
Long start up and braking operations	○	✓	✓
Irregular intermittent duty	○	✓	✓
Excessively high switching frequency	○	✓	✓
Single-phase operation and current unbalance	✓	✓	✓
Voltage and frequency fluctuations	✓	✓	✓
Stalling of the rotor	✓	✓	✓
Switching on a stalled rotor of a stator-critical motor	✓	✓	✓
Switching on a stalled rotor of a rotor-critical motor	✓	○	✓
Elevated ambient temperature	--	✓	✓
Impeded cooling	--	✓	✓

- ✓ Full protection
- Conditional protection
- No protection

Technical specifications

More information

Technical specifications, see <https://support.industry.siemens.com/cs/ww/en/ps/24302/td>
 Operating instructions and internal circuit diagrams, see <https://support.industry.siemens.com/cs/ww/en/ps/24302/man>

FAQs, see <https://support.industry.siemens.com/cs/ww/en/ps/24302/faq>
 For more information on explosion protection (ATEX), see www.siemens.com/sirius/atex

Type A PTC temperature sensor

If a Type A temperature sensor is connected to a Type A evaluation unit, compliance with the operating temperatures is assured (on pick-up and reset) according to IEC 60947-8.

The characteristic curves of the Type A temperature sensors are described in IEC 60947-8, EN 44081 and EN 44082 standards.

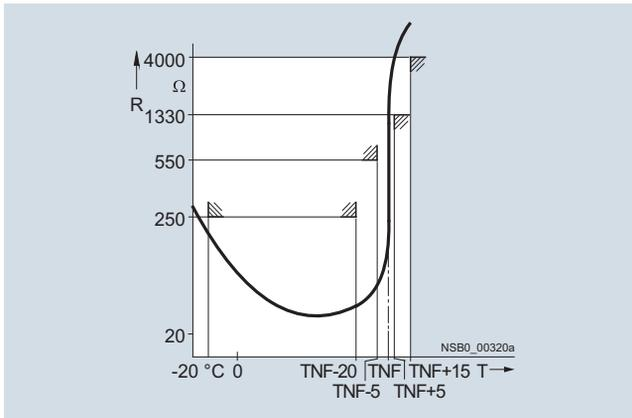

Characteristic curve of the 3RN2 evaluation unit

Bimetallic switch

In some applications, bimetallic switches (e.g. Klixon, Thermo-click) are used as sensors instead of PTC temperature sensors. Bimetallic switches are temperature- and current-dependent NC contacts and are available for different temperature ranges. Because bimetallic switches have practically no resistance below their opening temperature, short-circuit detection is not possible when using bimetallic switches. A bimetallic switch can be used for versions 3RN2000 and 3RN2010 on the SIRIUS thermistor motor protection relay.

Note:

Never use bimetallic switches in applications subject to an explosion hazard! Because of their non-standardized tripping characteristic, bimetallic switches must not be used in applications where there is an explosion hazard. Use Type A PTC sensors instead!

Use in hazardous areas

Increased danger in hazardous areas means it is necessary to observe the following notes and standards carefully:

- EN 60079-14/VDE 0165-1 for electrical apparatus for explosive gas atmospheres
- EN 60079-17 Explosive atmospheres – Electrical installations inspection and maintenance
- EN 50495 Safety devices required for the safe functioning of equipment with respect to explosion risks

The following SIRIUS 3RN2 thermistor motor protection relays with short-circuit detection are approved for Equipment Group II, Category (2) in Area "G" (areas in which potentially explosive gas, vapor, mist, or air mixtures are present) and are additionally approved for Area "D" (areas containing combustible dust):

- 3RN2011
- 3RN2012-...30
- 3RN2013
- 3RN2023

PTB 15 ATEX 3011 ex II (2) G (Ex E) (EX d) (Ex px)
 PTB 15 ATEX 3011 ex II (2) D (Ex T) (Ex p)

For 3RN2 thermistor motor protection relays, the EC type examination certificate is available for Group II, Category (2) G [Ex e] [Ex d] [Ex px] and D [Ex t] [Ex p]. The number is PTB 15 ATEX 3011.

SIRIUS 3RN2 thermistor motor protection relays are not intended for installation in hazardous areas. If they are installed in a potentially explosive atmosphere, the SIRIUS 3RN2 thermistor motor protection relays must be adapted to the applicable type of protection.

The machine or plant must shut down immediately if the SIRIUS 3RN2 thermistor motor protection relay is tripped, even if connected through a frequency converter. This must be implemented with circuitry.

SIRIUS 3RN2 thermistor motor protection relays with functional safety in accordance with EN 50495 are suitable for protecting explosion-proof motors/machines.

On evaluation units with a supply voltage of 24 V AC/DC, you must ensure electrical separation with a battery network or a power supply unit with electrical separation (e.g. isolating transformer) (does not apply to 3RN2013-BA30).

A SIRIUS 3RN2 thermistor motor protection relay set to "automatic RESET" mode will be reset automatically after the recovery time has elapsed, without the RESET button being pressed. An additional ON button has to be used to ensure that the motor does not start up automatically following tripping. "Automatic RESET" mode must not be used in applications where there is a risk of personal injury or damage to property if the motor restarts unexpectedly.

⚠ NOTICE!

When used in a hazardous area, the thermistor motor protection relay must not be operated with automatic RESET (terminal Y1 and Y2 permanently jumpered).

A risk analysis must be performed for the complete plant or machine. If this analysis yields a lower hazard potential (category 1), all SIRIUS 3RN2 thermistor motor protection relays can be used, provided the safety regulations are observed.

⚠ WARNING!

All work involved in connecting, commissioning and maintenance must be carried out by qualified, responsible personnel. Improper handling may result in serious personal injury and considerable damage to property.

Cable routing

The measuring circuit leads must be routed as separate control cables. It is not permitted to use cores from the supply line of the motor or any other main supply cables. If extreme inductive or capacitive interference is expected as a result of power lines routed in parallel, shielded control cables must be used.

Maximum length of sensor circuit cables for evaluation units without short-circuit detection in the sensor circuit:

Cable cross-section	3RN2000, 3RN2010
2.5 mm ²	2 x 2800 m
1.5 mm ²	2 x 1500 m
0.5 mm ²	2 x 500 m

Maximum length of sensor circuit cables for evaluation units with short-circuit detection¹⁾

Cable cross-section	3RN2011, 3RN2012, 3RN2013, 3RN2023
2.5 mm ²	2 x 250 m
1.5 mm ²	2 x 150 m
0.5 mm ²	2 x 50 m

¹⁾ A short circuit in the sensor circuit will be detected up to this maximum cable length.

Principle of operation

SIRIUS 3RN2 thermistor motor protection relays are thermal protection devices that are suitable, in combination with type A PTC thermistors, for monitoring temperatures of electrical drives, transformer windings, oils, bearings, air, etc.

The most frequent application is monitoring of three-phase motors in which the motor manufacturer has fitted a PTC sensor into every winding overhang and in which these PTC sensors are connected in series.

The SIRIUS 3RN2 thermistor motor protection relays operate in accordance with the closed-circuit principle and therefore monitor themselves for loss of supply voltage. The exceptions are the warning output on 3RN2023, which always works on the open-circuit principle and the bistable relays of the 3RN2012-.BW31, which always retain the last switching state.

A micro-interruption in the power supply of less than 30 ms does not change the status of the output relays.

For devices with the "Manual RESET" function, the test function can be activated and a trip simulated by pressing the blue Test/RESET button for > 2 seconds.

The 3RN2011, 3RN2012, 3RN2013 and 3RN2023 devices are additionally equipped with open-circuit and short-circuit detection in the sensor circuit. The unit will trip in the event of a short-circuit (resistance in sensor circuit < 10 Ω) or open circuit in the sensor circuit (dynamic open-circuit detection). Tripping as the result of a short-circuit in the sensor circuit is indicated by a flickering red LED (TRIPPED). In the event of a short-circuit in the sensor circuit for warning on the 3RN2023, the yellow warning LED (WARNING) flickers. The devices with dynamic open-circuit detection evaluate the rise time of the sensor circuit resistance. If the sensor circuit resistance rises from 3 300 Ω to 12 kΩ within 200 ms, the unit will not only trip, but also indicate the open circuit via a flashing red LED (TRIPPED). In the event of an open circuit in a sensor circuit, the yellow warning LED (WARNING) flashes for the 3RN2023.

All evaluation units (except for the 3RN2000 compact evaluation unit) feature electrical separation between the control circuit and the sensor circuit. The relay outputs are also electrically separated from all other circuits. The 3RN2013 and 3RN2023 evaluation units incorporate protective electrical separation between all circuits up to $U_i = 300$ V.

3RN2000 compact evaluation unit

The compact unit, which is only 17.5 mm wide, is equipped with a red LED (TRIPPED) for the tripped indicator and a changeover contact. After the unit has tripped, it is automatically reset once the thermistors have cooled down. The root of the changeover contact is connected to the control voltage (terminal 11 is connected to terminal A1). This unit is particularly suitable in circuits in which the control circuit and signaling circuit have the same potential, e.g. in local control boxes.

3RN2010, 3RN2011, 3RN2012 and 3RN2013 compact/standard evaluation units

The units are equipped with two LEDs (READY and TRIPPED) for an operating and tripped display and are available with either 1 NO + 1 NC contacts (3RN2010, overall width 17.5 mm) or with 2 CO contacts. Depending on the version, they are available with Auto RESET (3RN2010), Manual/Remote RESET (3RN2011) or Manual/Auto and Remote RESET (3RN2012 and 3RN2013). Remote RESET can be achieved by connecting an external pushbutton with a normally-open function to terminals Y1 and Y2. If terminals Y1 and Y2 are jumpered, the unit is automatically reset once the thermistors have cooled down (Auto RESET). 3RN2012 and 3RN2013 are non-volatile. This means a previous trip remains stored in the event of a control supply voltage failure – the thermistor motor protection relay remains in the safe state with an opened output relay until it is intentionally reset by pressing the TEST/RESET button of the unit or an external pushbutton.

3RN2023 "warning and disconnection" evaluation units

Two sensor circuits can be connected to one 3RN2023 evaluation unit that act on two separate output relays with 1 NO contact for warning and 1 CO contact for disconnection. Thermistors with different rated response temperatures TNF are used to implement the "Warning" and "Disconnection" functions. When sensor circuit 2 for "Warning" responds, a yellow LED is lit and when the "Disconnection" circuit responds, a red LED is lit. The sensor circuits have a different reset response and operating behavior: The "Warning" thermistor sensor circuit 2 (terminals 2T1, T2) works only with Auto RESET and according to the open-circuit principle (output relay K2, NO contact). The "Disconnection" thermistor sensor circuit 1, (terminals 1T1, T2) can be changed from Manual RESET to Auto RESET by jumpering terminals Y1 and Y2. Remote RESET is implemented by connecting an external pushbutton with a normally-open function to these terminals.

Function diagrams

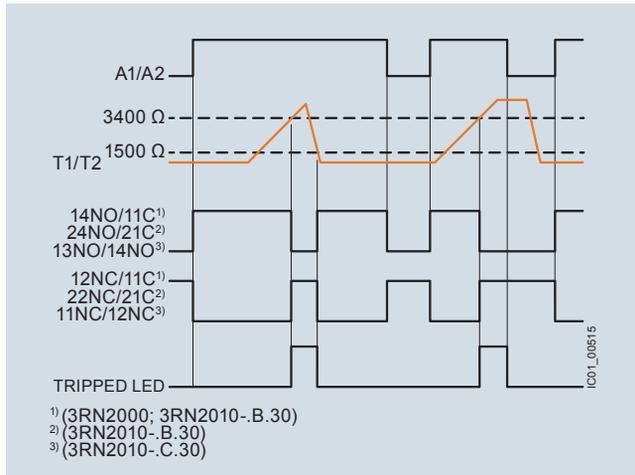

3RN2000, 3RN2010

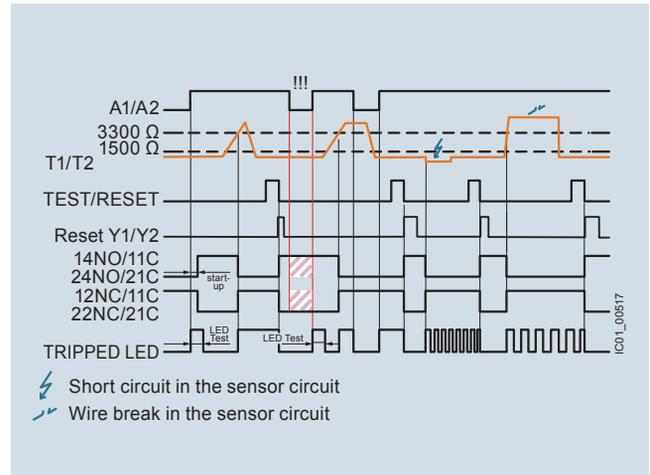

3RN2012-.BW31: resetting via the TEST/RESET button or external push-button

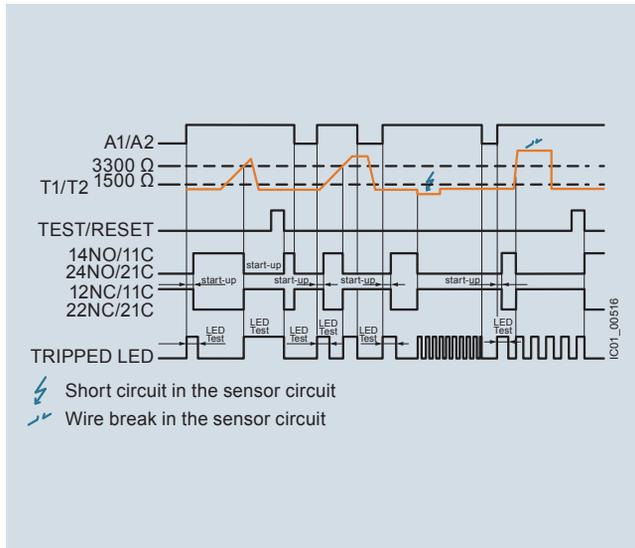

3RN2011: resetting via external pushbutton or interruption of the supply voltage

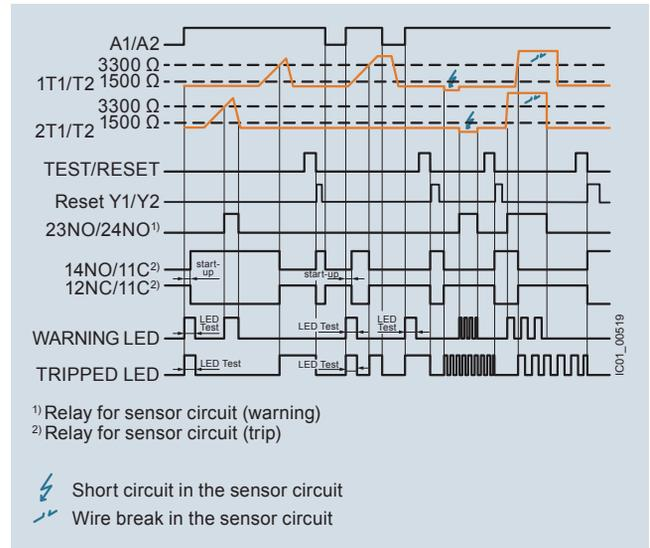

3RN2023: resetting via the TEST/RESET button or external pushbutton

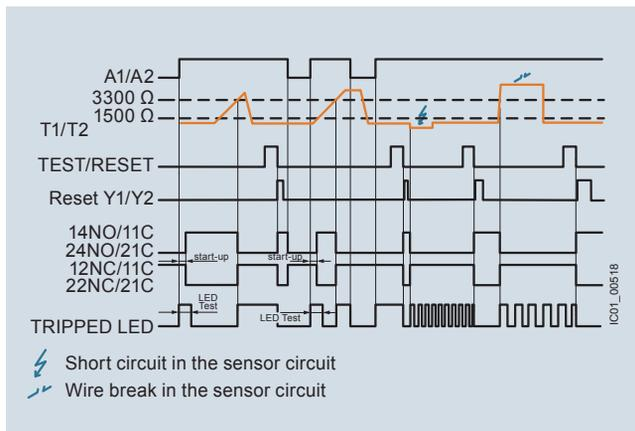

3RN2012-.B.30, 3RN2013: resetting via the TEST/RESET button or external pushbutton

Article number	3RN2000-.A, 3RN2010-.C	3RN201-.B, 3RN2013-.G, 3RN2023-.D
Width x height x depth	mm 100 × 17.5 × 90	100 × 22.5 × 90

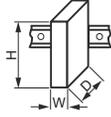

Article number	3RN2000-.AA30	3RN2000-.AW30, 3RN2010-.BW30, 3RN2010-.CW30	3RN2010-.BA30, 3RN2010-.CA30	3RN2011-.BA30, 3RN2012-.BA30	3RN2011-.BW30, 3RN2012-.BW30	3RN2012-.BW31	3RN2013-.BA30	3RN2013-.BW30, 3RN2013-.GW30	3RN2023-.DW30
----------------	----------------------	--	---	---	---	----------------------	----------------------	---	----------------------

General technical specifications									
Type of electrical isolation		None	Isolated				Protective separation		
Electrical endurance (operating cycles) for AC-15 at 230 V		100 000							
Mechanical endurance (operating cycles)		10 000 000							
Insulation voltage for overvoltage category III according to IEC 60664 for pollution degree 3 / rated value	V	300							
Impulse withstand voltage, rated value	kV	4				6			
Minimum mains failure buffering time	ms	40						30	
Pollution degree		3							
Degree of protection		IP20							
Vibration resistance acc. to IEC 60068-2-27		11g/15 ms							
Vibration resistance acc. to IEC 60068-2-6		10 ... 55 Hz; 0.35 mm							
Type of mounting		For screw-fixing and snap-on mounting to 35 mm standard mounting rail							
• Mounting position		Any							
• Installation altitude at height above sea level, maximum	m	2 000							
Ambient temperature during operation	°C	-25 ... +60							
Relative humidity during operation, maximum	%	70							
ATEX									
Ex device group and Ex category according to ATEX product directive 2014/34/EU		--		II 2G, II 2D	--		II 2G, II 2D		
Safety device type according to IEC 61508-2		--		Type B	--		Type B		
Safety integrity level (SIL) according to IEC 61508		--		SIL1	--		SIL1		
Performance level (PL) according to EN ISO 13849-1		--		c	--		c		
T1 value for proof test interval or service duration according to IEC 61508	y	--		3	--		3		
Measuring circuit									
Number of measuring circuits		1						2	
Relative measuring accuracy	%	9				2			
Maximum number of sensors in series		6							
Cable length of sensor, maximum	m	2 800			250				
Thermistor resistance response value	Ω	1 500 ... 1 650			1 500 ... 1 550				
Thermistor resistance return value	Ω	3 400 ... 3 600			3 300 ... 3 350				

Article number	3RN2000- .AA30	3RN2000- .AW30, 3RN2010- .BW30, 3RN2010- .CW30	3RN2010- .BA30, 3RN2010- .CA30	3RN2011- .BA30, 3RN2012- .BA30	3RN2011- .BW30, 3RN2012- .BW30	3RN2012- .BW31	3RN2013- .BA30	3RN2013- .BW30, 3RN2013- .GW30	3RN2023- .DW30
Control circuit									
Current carrying capacity of the output relay									
• At AC-15 at 250 V at 50/60 Hz	A	3							
• At DC-13 at 24 V	A	1							
• At DC-13 at 125 V	A	0.2							
• At DC-13 at 250 V	A	0.1							
Thermal current of the non-solid-state contact blocks, maximum	A	5							
Continuous current of the output relay's DIAZED fuse link	A	6							
Supply voltage									
Control supply voltage									
• At AC									
- At 50 Hz rated value	V	24 ... 24	24 ... 240	24 ... 24	24 ... 240		24 ... 24	24 ... 240	
- At 60 Hz rated value	V	24 ... 24	24 ... 240	24 ... 24	24 ... 240		24 ... 24	24 ... 240	
• At DC, rated value	V	24 ... 24	24 ... 240	24 ... 24	24 ... 240		24 ... 24	24 ... 240	
Operating range factor of the control supply voltage, rated value									
• At AC at 50 Hz		0.85 ... 1.1							
• At AC at 60 Hz		0.85 ... 1.1							
• At DC		0.85 ... 1.1							

Article number	3RN20..-1	3RN20..-2
Type of electrical connection	 Screw terminals	 Spring-type terminals (push-in)
Tightening torque	Nm 0.6 ... 0.8	--
Type of connectable conductor cross-sections		
• Solid	mm ² 1x (0.5 ... 4.0 mm ²), 2x (0.5 ... 2.5 mm ²)	1x (0.5 ... 4 mm ²)
• Finely stranded with end sleeve	mm ² 1x (0.5 ... 4 mm ²), 2x (0.5 ... 1.5 mm ²)	1x (0.5 ... 2.5 mm ²)
• For AWG cables		
- Solid	AWG 1x (20 ... 12), 2x (20 ... 14)	1x (20 ... 12)
- Stranded	AWG --	1x (20 ... 12)

Selection and ordering data



3RN2000-1AA30



3RN2010-1BA30



3RN2011-1BA30



3RN2012-1BW30



3RN2023-1DW30

Product function	Number of CO contacts for auxiliary contacts	Number of NO contacts for auxiliary contacts	Number of NC contacts for auxiliary contacts	Material of switching contacts	Control supply voltage For AC at 50 Hz rated value	Control supply voltage For DC, rated value	SD	Article No.	PU (UNIT, SET, M)	PS*
					V	V	d			

Compact evaluation unit, suitable for bimetallic switch

Terminal A1 jumpered with root of changeover contact

Auto RESET	1	0	0	AgSnO2	24 ... 24	24 ... 24	2	3RN2000-□AA30	1	1 unit
					24 ... 240	24 ... 240	2	3RN2000-□AW30	1	1 unit
	0	1	1	AgSnO2	24 ... 24	24 ... 24	2	3RN2010-□CA30	1	1 unit
					24 ... 240	24 ... 240	2	3RN2010-□CW30	1	1 unit

Standard evaluation unit, suitable for bimetallic switch

Auto RESET	2	0	0	AgSnO2	24 ... 24	24 ... 24	2	3RN2010-□BA30	1	1 unit
					24 ... 240	24 ... 240	2	3RN2010-□BW30	1	1 unit

Bistable evaluation unit, open-circuit and short-circuit detection in the sensor circuit

Does not trigger in the event of control supply voltage failure

Auto RESET	2	0	0	AgSnO2	24 ... 240	24 ... 240	2	3RN2012-□BW31	1	1 unit
Manual RESET										
External RESET										
Error memory										

Standard evaluation unit with ATEX approval, open-circuit and short-circuit detection in the sensor circuit¹⁾

Manual RESET	2	0	0	AgSnO2	24 ... 24	24 ... 24	2	3RN2011-□BA30	1	1 unit
External RESET					24 ... 240	24 ... 240	2	3RN2011-□BW30	1	1 unit

Non-volatile³⁾

Auto RESET	2	0	0	AgSnO2	24 ... 24	24 ... 24	2	3RN2012-□BA30	1	1 unit
Manual RESET					24 ... 240	24 ... 240	2	3RN2012-□BW30	1	1 unit
External RESET										
Error memory										

Protective separation, non-volatile²⁾³⁾

Auto RESET	2	0	0	AgSnO2	24 ... 24	24 ... 24	2	3RN2013-□BA30	1	1 unit
Manual RESET					24 ... 240	24 ... 240	2	3RN2013-□BW30	1	1 unit
External RESET										
Error memory				AgSnO2 Hard gold-plated	24 ... 240	24 ... 240	2	3RN2013-□GW30	1	1 unit

Evaluation unit with ATEX approval and 2 sensor circuits for warning and disconnection, open-circuit and short-circuit detection in both sensor circuits

Protective separation, non-volatile²⁾³⁾

Auto RESET	1	1	0	AgSnO2	24 ... 240	24 ... 240	2	3RN2023-□DW30	1	1 unit
Manual RESET										
External RESET										
Error memory										

Type of electrical connection

- Screw terminals
- Spring-type terminals (push-in)

1
2

¹⁾ For 3RN2011: The unit can be reset with the RESET button or by disconnecting the control supply voltage.

²⁾ Protective separation up to 300 V acc. to DIN/VDE 0160, IEC 60947-1.

³⁾ Protection against voltage failure or non-volatile fault storage means that previous tripping due to a fault remains stored even if the control supply voltage fails. The monitoring device is not reset if the voltage fails. With an active fault, meaning a fault which has not been manually confirmed, an automatic restart of the plant upon recovery of the power is prevented therefore and plant safety increased as the result.

Accessories

Version	SD	Article No.	PU (UNIT, SET, M)	PS*
Terminals for SIRIUS devices in the industrial standard mounting rail enclosure				
 3ZY1122-1BA00	Removable terminals		Screw terminals 	
	• 2-pole, up to 2 x 2.5 mm ² or 1 x 4 mm ²	2	3ZY1122-1BA00	1 6 units
	Spring-type terminals (push-in) 			
	• 2-pole, up to 1 x 4 mm ² or 2 x 1.5 mm ²	2	3ZY1122-2BA00	1 6 units
Accessories for enclosures				
 3ZY1311-0AA00	Push-in lugs For wall mounting		3ZY1311-0AA00	
		2		1 10 units
 3ZY1440-1AA00	Coding pins For removable terminals of SIRIUS devices in the industrial standard mounting rail enclosure. They enable the mechanical coding of terminals, see Manual "SIRIUS 3RN2 thermistor motor protection", https://support.industry.siemens.com/cs/ww/en/ps/24302/man		3ZY1440-1AA00	
		2		1 12 units
Tools for opening spring-type terminals				
 3RA2908-1A	Screwdrivers For all SIRIUS devices with spring-type terminals 3.0 mm x 0.5 mm, length approx. 200 mm, titanium gray/black, partially insulated		Spring-type terminals (push-in) 	
		2	3RA2908-1A	1 1 unit

Overview

7PV15, SIRIUS 3RP25 and SIRIUS 3RP20 timing relays

Electronic timing relays are used in control, starting, and protective circuits for all switching operations involving time delays. Their fully developed concept and space-saving, compact design make the SIRIUS 3RP timing relays ideal modules for control cabinet, switchgear and control manufacturers in the industry.

With their narrow design, the 7PV15 timing relays are ideal in particular for use in heating, ventilation and air-conditioning systems and in compressors. All 7PV15 timing relays in this enclosure version are suitable for snap-on mounting onto TH 35 standard mounting rails according to IEC 60175. The enclosure complies with DIN 43880.

Benefits

- Clear-cut basic range with five basic units in the case of the 7PV15 timing relays, and seven basic units in the case of the 3RP timing relays
- Logistic advantages provided by versions with wide voltage range and wire setting range
- No tools required for assembly or disassembly on standard mounting rails
- Cadmium-free relay contacts
- Recyclable, halogen-free enclosure
- Optimum price/performance ratio
- Versions with logical separation
- Low variance: One design for distribution boards and for control cabinets
- Compliance with EMC requirements for buildings
- Environmentally friendly laser inscription instead of printing containing solvents
- Timing relays suitable for the 3RT miniature contactors allow smaller tier spacing
- Versions with screw terminals or alternatively with spring-type terminals

Application**Timing relays with ON-delay**

- Interference pulse suppression (gating of interference pulses)
- Gradual startup of motors so as not to overload the power supply

Timing relays with OFF-delay

- Generation of overtravel functions following removal of voltage
- Gradual, delayed shutdown, e.g. of motors or fans, to allow a plant to be shut down selectively

Wye-delta timing relay

- Switchover of motors from wye to delta with a dead interval of 50 ms to prevent phase-to-phase short circuits

Multifunctional timing relays

- Maximum flexibility, with a device for every application
- Available with relay and semiconductor output

Timing Relays

3RP25 timing relays

Overview

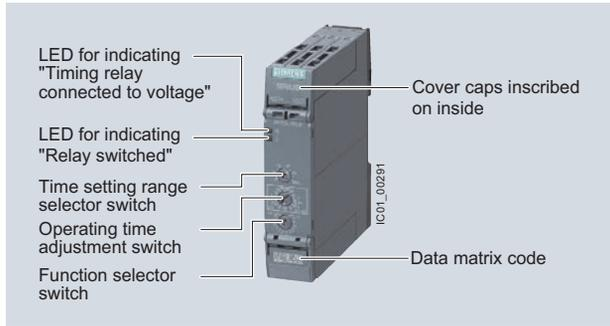

SIRIUS 3RP25 timing relays

Electronic timing relays for general use in control systems and mechanical engineering with:

- 1 or 2 CO, 1 NO (semiconductor) or 3 NO
- Monofunction or multifunction
- Combination voltage
- Wide voltage range
- Single or selectable time setting ranges
- Switch position indication and voltage indication by LED

Standards

The timing relays comply with:

- IEC 60721-3-3 "Classification of environmental conditions"
- IEC 61812-1/DIN VDE 0435 Part 201 "Specified time relays for industrial use"
- IEC 61000-6-2, IEC 61000-6-3 and IEC 61000-6-4 "Electromagnetic compatibility"
- IEC 60947-5-1 "Low-voltage switchgear and controlgear – Electromechanical control circuit devices"

3RP2505 multifunctional timing relays

The functions of the 3RP2505 multifunctional timing relays can be set by means of the function selector switch. Whether both CO contacts are switched in parallel or one CO contact with a delay and one instantaneously and the choice of time setting range are set by means of the time setting range selector switch. The exact operating time can be adjusted with the operating time switch.

With a set of foil labels the timing relay can be legibly marked with the functions which can be selected on the timing relay. This is supplied together with the multifunctional timing relay.

The same potential must be applied to terminals A. and B.

Functions, [see the overview of functions on page 11/26](#).

Note:

The activation of loads parallel to the start input is permissible when using AC/DC control voltage ([see diagram](#)).

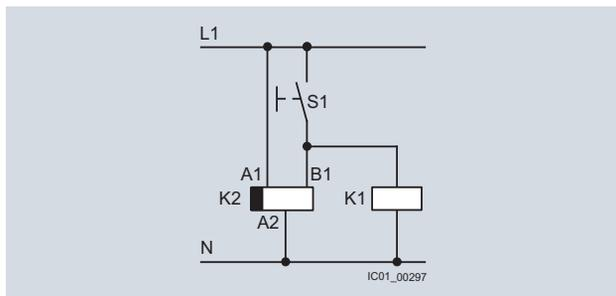

Diagram

Accessories



Push-in lugs for wall mounting



Sealable cover 17.5 mm



Sealable cover 22.5 mm

Two setting options for implementing the multifunctions (A-M):

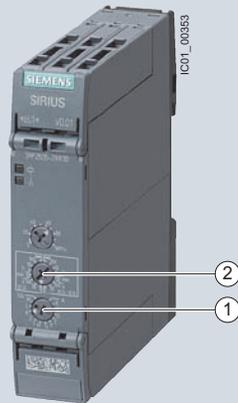

- ① Determination of 13 functions by the setting A to M, with 1 CO, 1 NO, 2 CO that switch in parallel.
- ② Extended function variance by selecting the time range and determining, whether 2 CO switch in parallel or whether 1 CO switches with delay + 1 CO switches immediately (1 CO + 1 CO)

Setting the functions on the device

Overview of functions of the 3RP2505 multifunctional timing relay

Identification letter	13 functions 1 CO, 1 NO (semiconductor) or 2 CO switched in parallel	27 functions 13 functions (A - M) 2 CO switched in parallel + 13 functions (A - M) 1 CO delayed + 1 CO instantaneous (1 CO + 1 CO) and wye-delta function
A	ON-delay	ON-delay and instantaneous contact
B	OFF-delay with control signal	OFF-delay with control signal and instantaneous contact
C	ON-delay/OFF-delay with control signal	ON-delay/OFF-delay with control signal and instantaneous contact
D	Flashing, symmetrical, starting with interval	Flashing, symmetrical, starting with interval and instantaneous contact
E	Passing make contact, interval relay	Passing make contact, interval relay and instantaneous contact
F	Retriggerable interval relay with deactivated control signal (passing break contact with control signal)	Retriggerable interval relay with deactivated control signal (passing break contact with control signal) and instantaneous contact
G	Passing make contact, with control signal, not retriggerable (pulse-forming with control signal)	Passing make contact, with control signal, not retriggerable (pulse-forming with control signal) and instantaneous contact
H	Additive ON-delay, instantaneous OFF with control signal	Additive ON-delay, instantaneous OFF with control signal and instantaneous contact
I	Additive ON-delay with control signal	Additive ON-delay with control signal and instantaneous contact
J	Flashing, symmetrical, starting with pulse	Flashing, symmetrical, starting with pulse and instantaneous contact
K	Pulse-delayed (fixed pulse (at 1 s) and settable pulse delay)	Pulse-delayed (fixed pulse (at 1 s) and settable pulse delay) and instantaneous contact
L	Pulse-delayed with control signal (fixed pulse (at 1 s) and settable pulse delay)	Pulse-delayed with control signal (fixed pulse (at 1 s) and settable pulse delay) and instantaneous contact
M	Retriggerable interval relay with activated control signal (watchdog)	Retriggerable interval relay with activated control signal and instantaneous contact (watchdog)
--	--	Wye-delta function

Note:

Conversion tool e.g. from 3RP15 to 3RP25, see www.siemens.com/sirius/conversion-tool.

Timing Relays

3RP25 timing relays, 17.5 mm and 22.5 mm

Article No. scheme

Digit of the Article No.	1 st - 5 th	6 th	7 th	-	8 th	9 th	10 th	11 th	12 th
	□□□□□	□	□	-	□	□	□	□	0
Timing relays in industrial enclosure 17.5 mm and 22.5 mm	3 R P 25								
Functions/time setting ranges		□	□						
Connection type					□				
Contacts						□			
Rated control supply voltage							□	□	
Example	3 R P 25	0	5	-	1	A	W	3	0

Note:

The Article No. scheme is presented here merely for information purposes and for better understanding of the logic behind the article numbers.

For your orders, please use the article numbers quoted in the catalog in the Selection and ordering data.

Benefits

- Easy stock keeping and logistics thanks to low variance of devices
- Reduced space requirement in the control cabinet thanks to variants in width 17.5 mm and 22 mm
- Consistent for all functions thanks to wide voltage range from 12 to 240 V AC/DC
- Up to 27 functions according to IEC 61812 in the multifunctional timing relay with wide voltage range
- Multifunctional timing relay with semiconductor output for high switching frequencies, bounce-free and wear-free switching

Application

Timing relays are used in control, starting, and protective circuits for all switching operations involving time delays. They guarantee a high level of functionality and a high repeat accuracy of timer settings.

Enclosure version

All timing relays are suitable for snap-on mounting onto TH 35 standard mounting rails according to IEC 60715 or for screw fixing.

Timing Relays

3RP25 timing relays, 17.5 mm and 22.5 mm

Technical specifications

Type	3RP2505-.A, 3RP2505-.C, 3RP251., 3RP2525-.A, 3RP2527, 3RP253., 3RP255.	3RP2505-.B, 3RP2505-.R, 3RP2525-.B, 3RP254., 3RP256., 3RP257.
Width	mm 17.5	22.5
Height	mm 100	100
Depth	mm 90	90

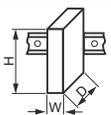

Type	3RP25...-AB30, 3RP25...-AW30, 3RP25...-BB30, 3RP25...-BW30, 3RP25...-NW30, 3RP25...-SW30	3RP25...-BT20, 3RP25...-NM20	3RP25...-CW30	3RP25...-EW30	3RP25...-RW30
Insulation voltage For overvoltage category III According to IEC 60664 For pollution degree 3, rated value	V AC 300	500	300	--	300
Ambient temperature					
• During operation	°C -25 ... +60				-40 ... +70
• During storage	°C -40 ... +85				
Operating range factor Of the control supply voltage, rated value					
• At AC					
- At 50 Hz	0.85 ... 1.1				0.7 ... 1.1
- At 60 Hz	0.85 ... 1.1				0.7 ... 1.1
• At DC	0.85 ... 1.1	--	0.85 ... 1.1	0.85 ... 1.1	0.7 ... 1.1
Switching capacity current With inductive load	A 0.01 ... 3	0.01 ... 3	0.01 ... 1	0.01 ... 6	0.01 ... 3
Operational current of the auxiliary contacts					
• At AC-15					
- At 24 V	A 3	3	1	--	3
- At 250 V	A 3	3	1	--	3
- At 400 V	A --	3	--	--	--
• At DC-12					
- At 24 V	A --	--	1	--	--
- At 125 V	A --	--	1	--	--
- At 250 V	A --	--	1	--	--
• At DC-13					
- At 24 V	A 1	1	--	--	1
- At 125 V	A 0.2	0.2	--	--	0.2
- At 250 V	A 0.1	0.1	--	--	0.1
Uninterrupted thermal current I_{th}	A 5	5	1	0.6	5
Mechanical endurance (Operating cycles) Typical		10 x 10 ⁶			
Electrical endurance For AC-15 at 230 V, typical		1 x 10 ⁵			

Type	3RP25
Connection type	 Screw terminals
• Design of thread of connection screw	M3
• Solid	mm ² 1 x (0.5 ... 4.0)/2 x (0.5 ... 2.5)
• Finely stranded with end sleeve	mm ² 1 x (0.5 ... 4)/2 x (0.5 ... 1.5)
• Solid for AWG cables	AWG 1 x (20 ... 12), 2 x (20 ... 14)
• Stranded for AWG cables	AWG 1 x (20 ... 12), 2 x (20 ... 14)
• Tightening torque	Nm 0.6 ... 0.8
Connection type	 Spring-type terminals
• Solid	mm ² 1 x (0.5 ... 4)
• Finely stranded with end sleeve	mm ² 1 x (0.5 ... 2.5)
• AWG cables, solid	AWG 1 x (20 ... 12)

Timing Relays

3RP25 timing relays, 17.5 mm and 22.5 mm

Internal circuit diagrams 3RP25

Multifunction 3RP2505-.A, 13 functions, 1 CO

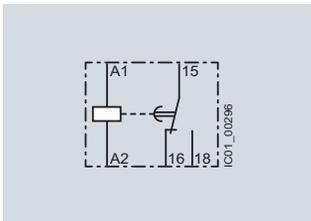

3RP2505-.A (A)
ON-delay

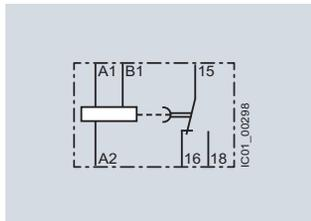

3RP2505-.A (B)
OFF-delay with control signal

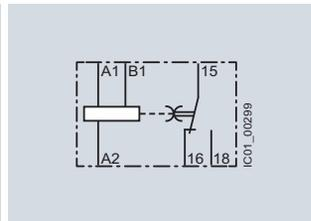

3RP2505-.A (C)
ON-delay/OFF-delay
with control signal

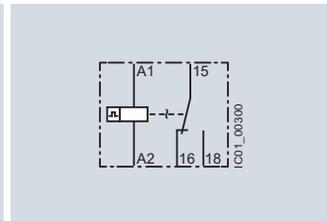

3RP2505-.A (D)
Flashing, symmetrical,
starting with interval

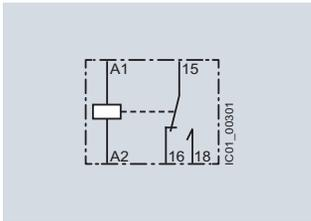

3RP2505-.A (E)
Passing make contact, interval relay

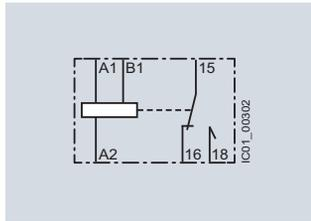

3RP2505-.A (F)
Retriggerable interval relay with
deactivated control signal (passing
break contact with control signal)

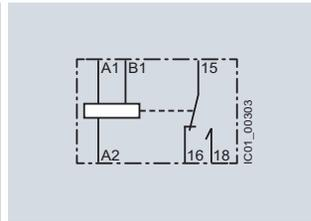

3RP2505-.A (G)
Passing make contact with
control signal, not retriggerable
(pulse-forming with control signal)

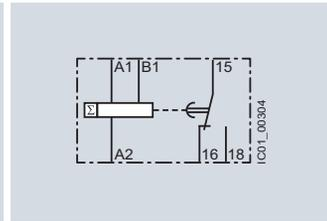

3RP2505-.A (H)
Additive ON-delay, instantaneous OFF
with control signal

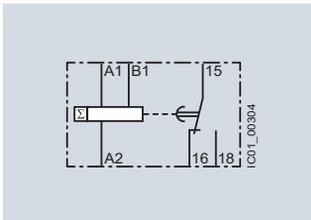

3RP2505-.A (I)
Additive ON-delay with control signal

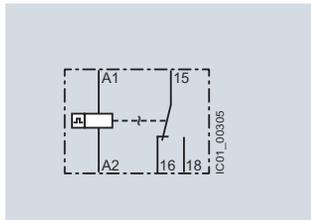

3RP2505-.A (J)
Flashing, symmetrical,
starting with pulse

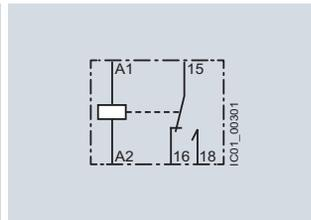

3RP2505-.A (K)
Pulse-delayed (fixed pulse (at 1 s)
and settable pulse delay)

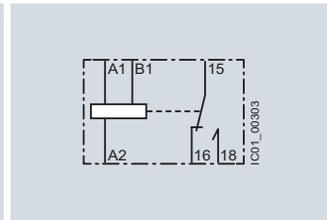

3RP2505-.A (L)
Pulse-delayed with control signal (fixed
pulse (at 1 s) and settable pulse delay)

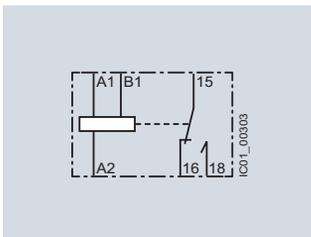

3RP2505-.A (M)
Retriggerable interval relay with
activated control signal (watchdog)

Timing Relays

3RP25 timing relays, 17.5 mm and 22.5 mm

Multifunction 3RP2505-.C, 13 functions, 1 NO (semiconductor)

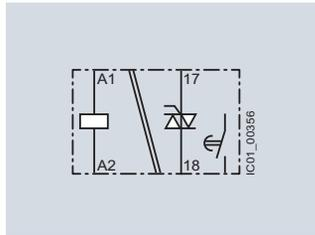

3RP2505-.C (A)
ON-delay

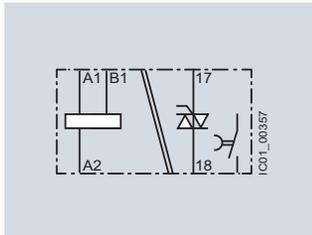

3RP2505-.C (B)
OFF-delay with control signal

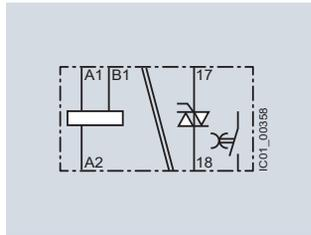

3RP2505-.C (C)
ON-delay/OFF-delay
with control signal

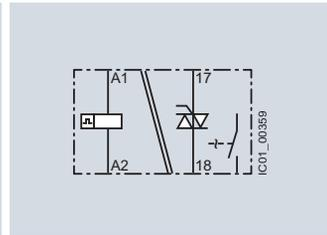

3RP2505-.C (D)
Flashing, symmetrical,
starting with interval

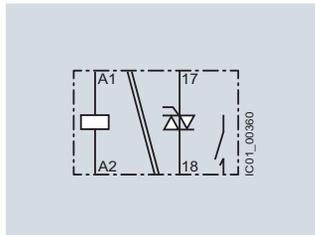

3RP2505-.C (E)
Passing make contact, interval relay

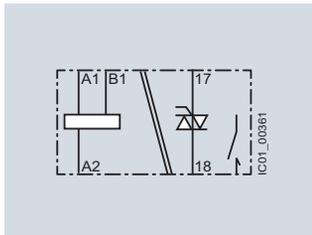

3RP2505-.C (F)
Retriggerable interval relay with
deactivated control signal (passing
break contact with control signal)

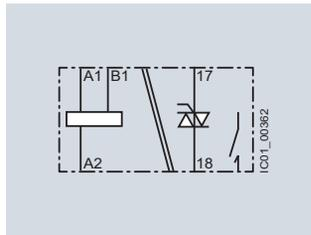

3RP2505-.C (G)
Passing make contact with
control signal, not retriggerable
(pulse-forming with control signal)

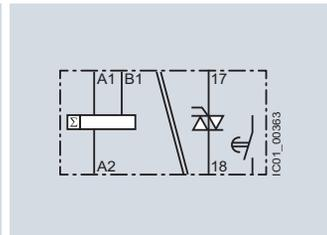

3RP2505-.C (H)
Additive ON-delay, instantaneous OFF
with control signal

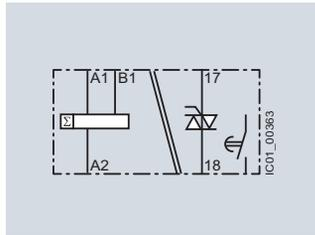

3RP2505-.C (I)
Additive ON-delay with control signal

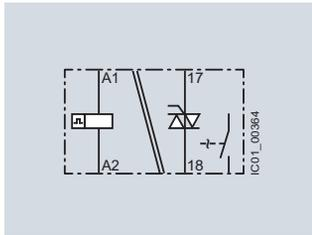

3RP2505-.C (J)
Flashing, symmetrical,
starting with pulse

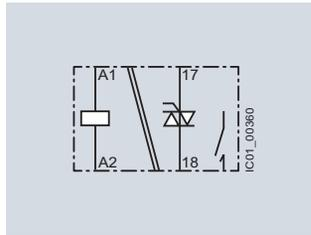

3RP2505-.C (K)
Pulse-delayed (fixed pulse (at 1 s)
and settable pulse delay)

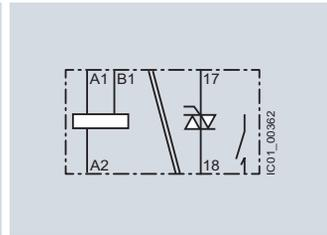

3RP2505-.C (L)
Pulse-delayed with control signal (fixed
pulse (at 1 s) and settable pulse delay)

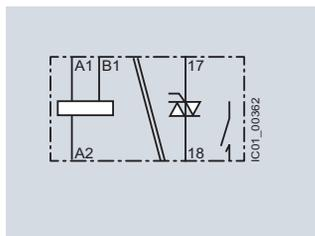

3RP2505-.C (M)
Retriggerable interval relay with
activated control signal (watchdog)

Timing Relays

3RP25 timing relays, 17.5 mm and 22.5 mm

Multifunction 3RP2505-.B, 27 functions, 2 CO switched in parallel with delay/
multifunction 3RP2505-.R, 13 functions, 2 CO positively driven, and switched in parallel with delay (see also note below)

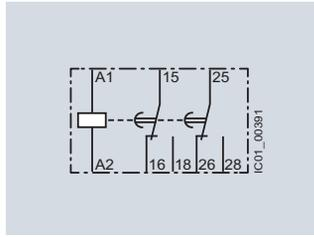

3RP2505-.B (A)
ON-delay

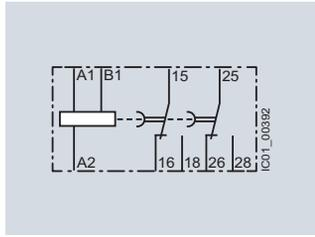

3RP2505-.B (B)
OFF-delay with control signal

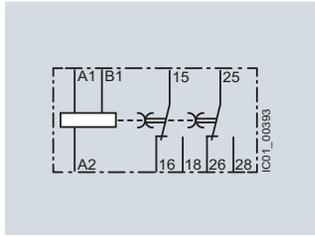

3RP2505-.B (C)
ON-delay/OFF-delay
with control signal

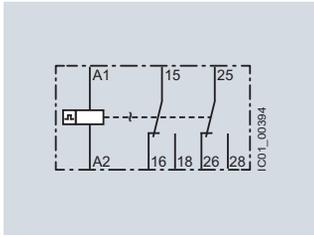

3RP2505-.B (D)
Flashing, symmetrical,
starting with interval

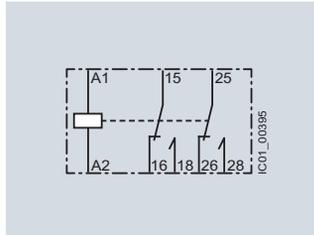

3RP2505-.B (E)
Passing make contact, interval relay

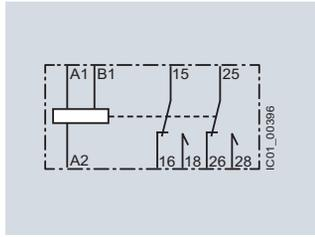

3RP2505-.B (F)
Retriggerable interval relay with
deactivated control signal (passing
break contact with control signal)

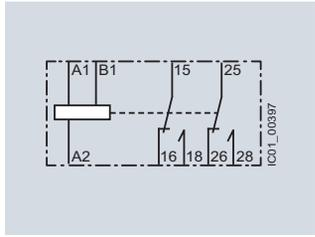

3RP2505-.B (G)
Passing make contact with
control signal, not retriggerable
(pulse-forming with control signal)

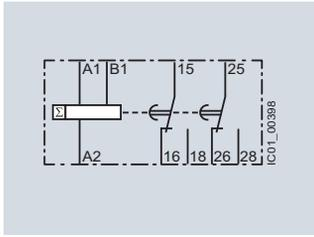

3RP2505-.B (H)
Additive ON-delay, instantaneous OFF
with control signal

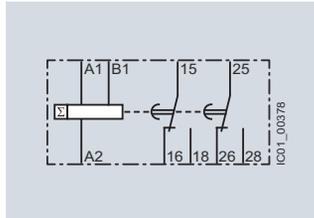

3RP2505-.B (I)
Additive ON-delay with control signal

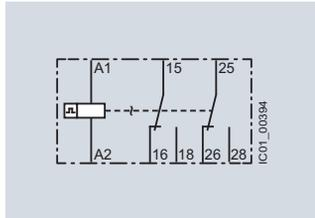

3RP2505-.B (J)
Flashing, symmetrical,
starting with pulse

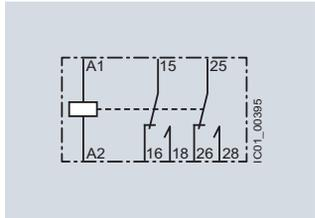

3RP2505-.B (K)
Pulse-delayed (fixed pulse (at 1 s)
and settable pulse delay)

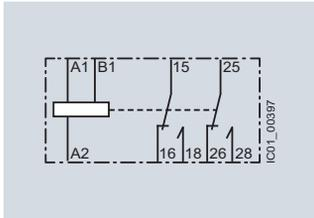

3RP2505-.B (L)
Pulse-delayed with control signal (fixed
pulse (at 1 s) and settable pulse delay)

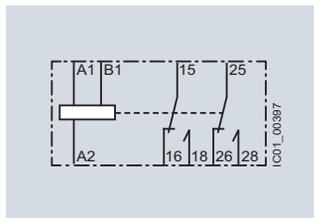

3RP2505-.B (M)
Retriggerable interval relay with
activated control signal (watchdog)

Note:

3RP2505-.RW30 has 13 functions (A to M) like 3RP2505-.B switched in parallel with delay, but with positively driven contacts. The circuit diagrams are identical except for the representation of the symbols for these contacts, see also the example on the right for 3RP2505-.RW30 of the function (A) with ON-delay.

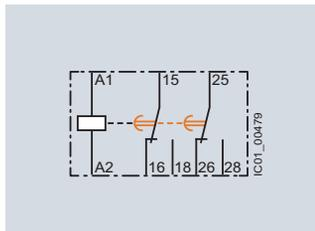

3RP2505-.B (A)
ON-delay

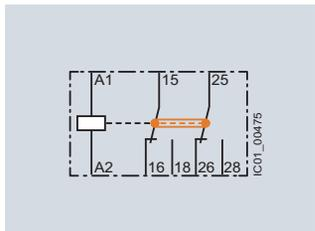

3RP2505-.R (A)
with positively driven contacts
ON-delay

Timing Relays

3RP25 timing relays, 17.5 mm and 22.5 mm

Multifunction 3RP2505-.B, 27 functions, 1 CO delayed + 1 CO instantaneous (continued)

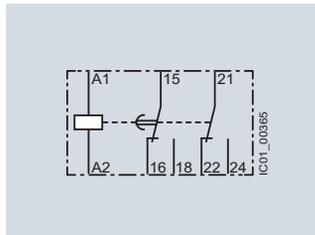

3RP2505-.B (A)
ON-delay and instantaneous contact

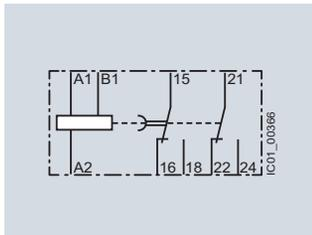

3RP2505-.B (B)
OFF-delay with control signal and instantaneous contact

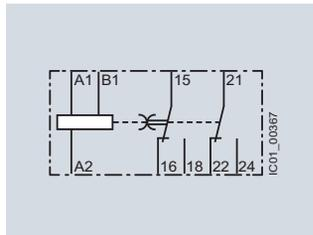

3RP2505-.B (C)
ON-delay/OFF-delay with control signal and instantaneous contact

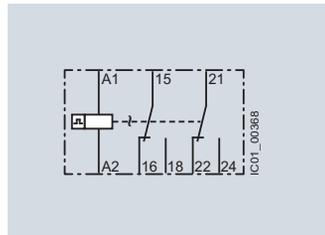

3RP2505-.B (D)
Flashing, symmetrical, starting with interval and instantaneous contact

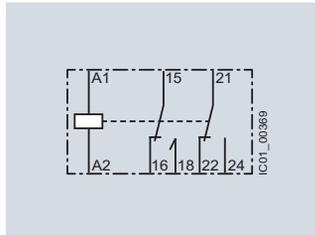

3RP2505-.B (E)
Passing make contact, interval relay and instantaneous contact

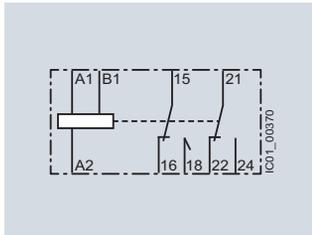

3RP2505-.B (F)
Retriggerable interval relay with deactivated control signal (passing break contact with control signal) and instantaneous contact

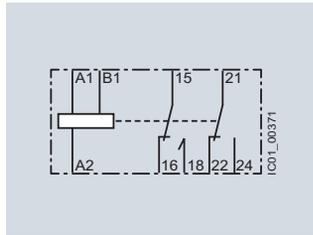

3RP2505-.B (G)
Passing make contact with control signal, not retriggerable (pulse-forming with control signal) and instantaneous contact

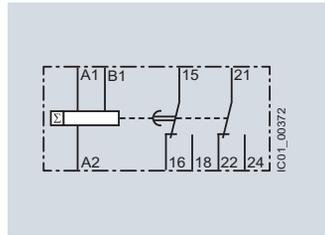

3RP2505-.B (H)
Additive ON-delay, instantaneous OFF with control signal and instantaneous contact

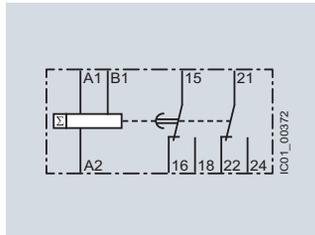

3RP2505-.B (I)
Additive ON-delay with control signal and instantaneous contact

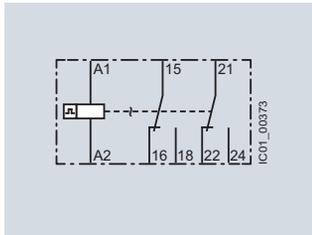

3RP2505-.B (J)
Flashing, symmetrical, starting with pulse and instantaneous contact

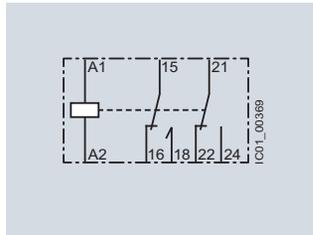

3RP2505-.B (K)
Pulse-delayed (fixed pulse (at 1 s) and settable pulse delay) and instantaneous contact

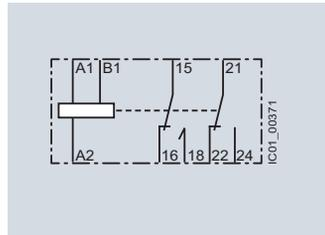

3RP2505-.B (L)
Pulse-delayed with control signal (fixed pulse (at 1 s) and settable pulse delay) and instantaneous contact

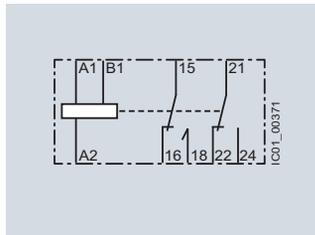

3RP2505-.B (M)
Retriggerable interval relay with activated control signal and instantaneous contact (watchdog)

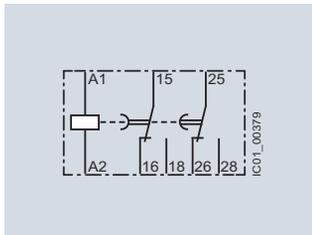

3RP2505-.B
Wye-delta function

Timing Relays

3RP25 timing relays, 17.5 mm and 22.5 mm

Monofunctions 3RP251. up to 3RP257.¹⁾

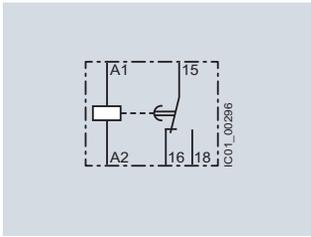

3RP251., 3RP2525-A
ON-delay

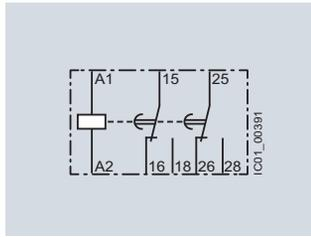

3RP2525-B
ON-delay

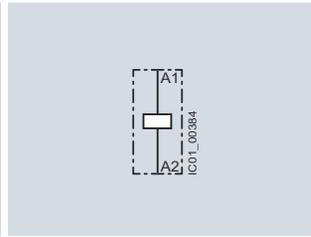

3RP2527
ON-delay, two-wire design

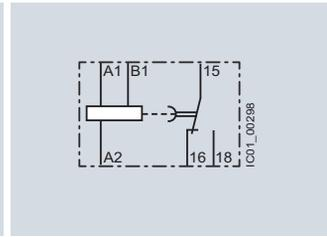

3RP2535
OFF-delay with control signal

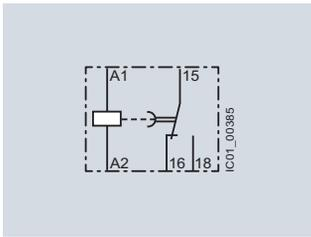

3RP2540-A (N)¹⁾
OFF-delay

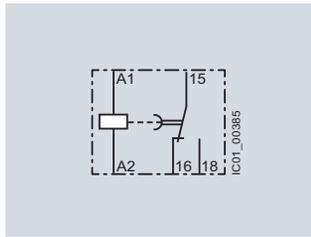

3RP2540-A (O)¹⁾
Positive passing make contact

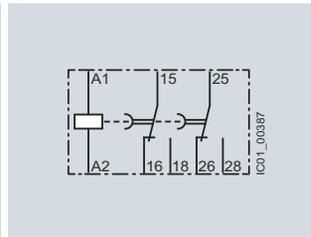

3RP2540-B (N)¹⁾
OFF-delay

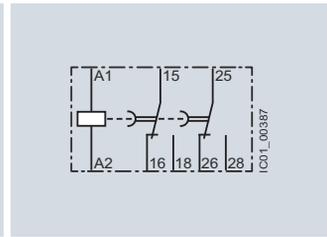

3RP2540-B (O)¹⁾
Positive passing make contact

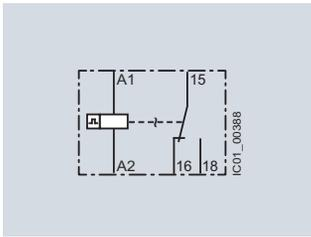

3RP2555
Flashing, asymmetrical, starting with interval (clock-pulse relay)

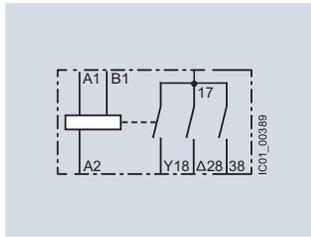

3RP2560
Wye-delta function with overtravel function (idling)

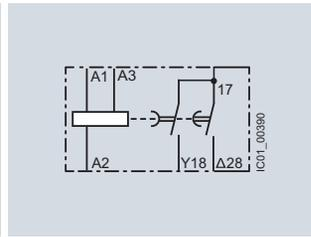

3RP257.
Wye-delta function

¹⁾ 3RP2540 has a double function:
Function N = OFF-delay
Function O = Positive passing make contact.

3RP25 function diagrams

Multifunction 3RP2505-.A, 1 CO, 13 functions and 3RP2505-.C, 1 NO (semiconductor), 13 functions

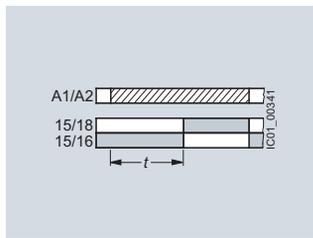

A
ON-delay

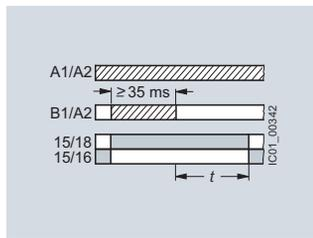

B
OFF-delay with control signal

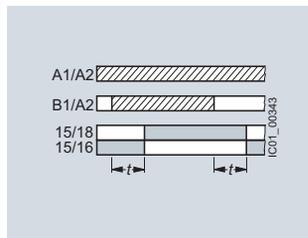

C
ON-delay/OFF-delay with control signal

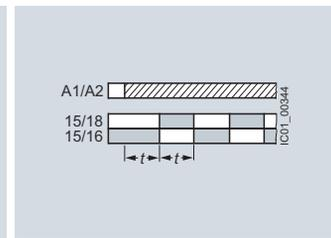

D
Flashing, symmetrical, starting with interval

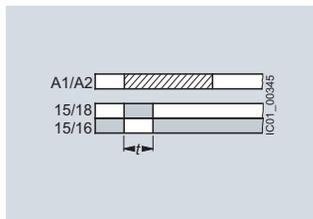

E
Passing make contact, interval relay

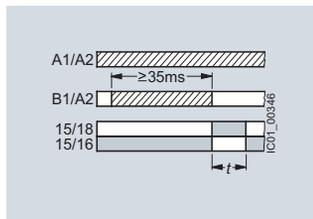

F
Retriggerable interval relay with deactivated control signal (passing break contact with control signal)

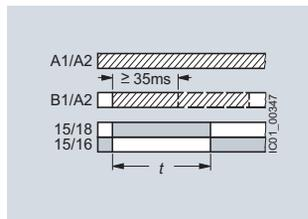

G
Passing make contact with control signal, not retriggerable (pulse-forming with control signal)

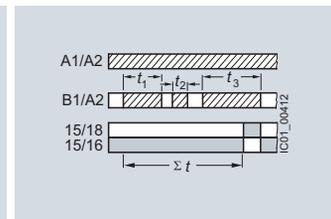

H
Additive ON-delay, instantaneous OFF with control signal

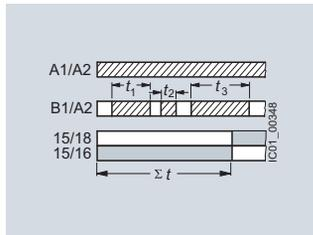

I
Additive ON-delay, with control signal

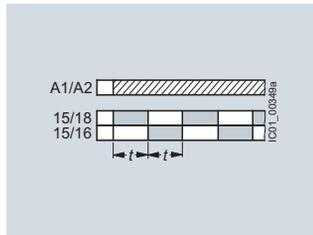

J
Flashing, symmetrical, starting with pulse

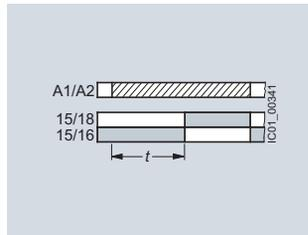

K
Pulse-delayed (fixed pulse (at 1 s) and settable pulse delay)

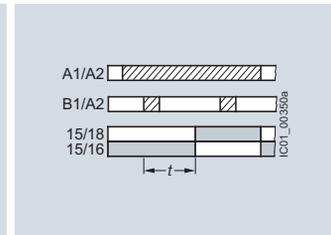

L
Pulse-delayed with control signal (fixed pulse (at 1 s) and settable pulse delay)

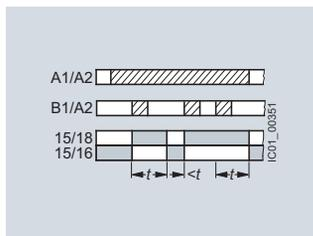

M
Retriggerable interval relay with activated control signal (watchdog)

Legend

- A ... M** Identification letters
- Timing relay energized
- Contact closed
- Contact open

Timing Relays

3RP25 timing relays, 17.5 mm and 22.5 mm

Multifunction 3RP2505-.B, 13 functions, 2 CO positively driven and switched in parallel with delay

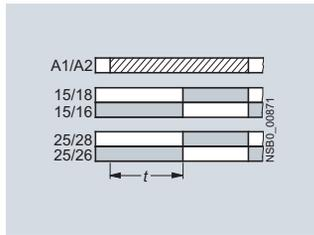

A
ON-delay

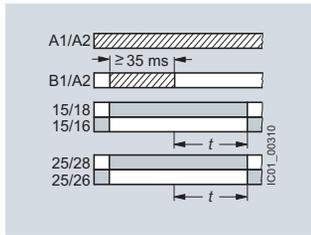

B
OFF-delay with control signal

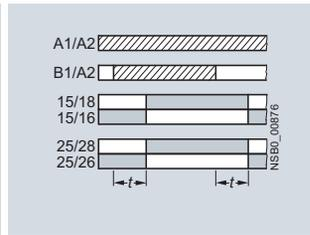

C
ON-delay/OFF-delay
with control signal

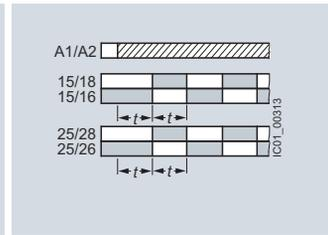

D
Flashing, symmetrical,
starting with interval

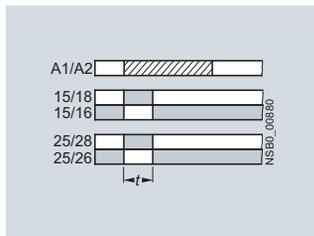

E
Passing make contact, interval relay

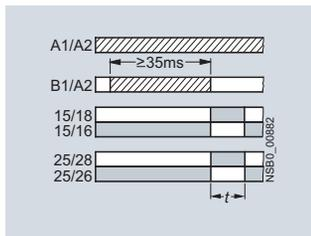

F
Retriggerable interval relay with
deactivated control signal (passing
break contact with control signal)

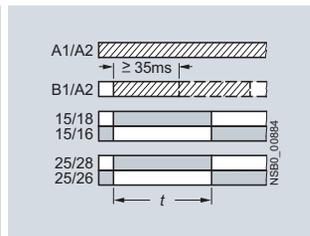

G
Passing make contact with
control signal, not retriggerable
(pulse-forming with control signal)

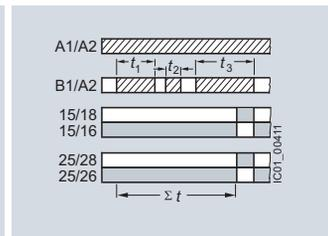

H
Additive ON-delay, instantaneous OFF
with control signal

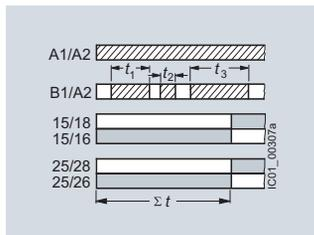

I
Additive ON-delay with control signal

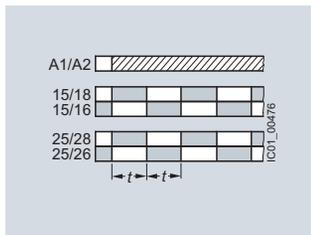

J
Flashing, symmetrical,
starting with pulse

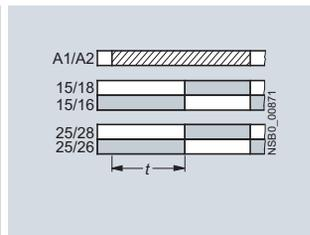

K
Pulse-delayed (fixed pulse at 1 s
and settable pulse delay)

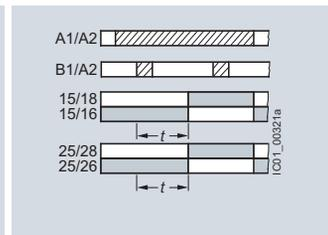

L
Pulse-delayed with control signal (fixed
pulse at 1 s and settable pulse delay)

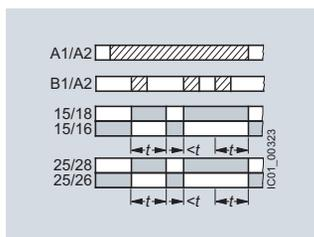

M
Retriggerable interval relay with
activated control signal (watchdog)

Legend

- A ... M** Identification letters
- Timing relay energized
- Contact closed
- Contact open

Multifunction 3RP2505-.B, 27 functions, 2 CO

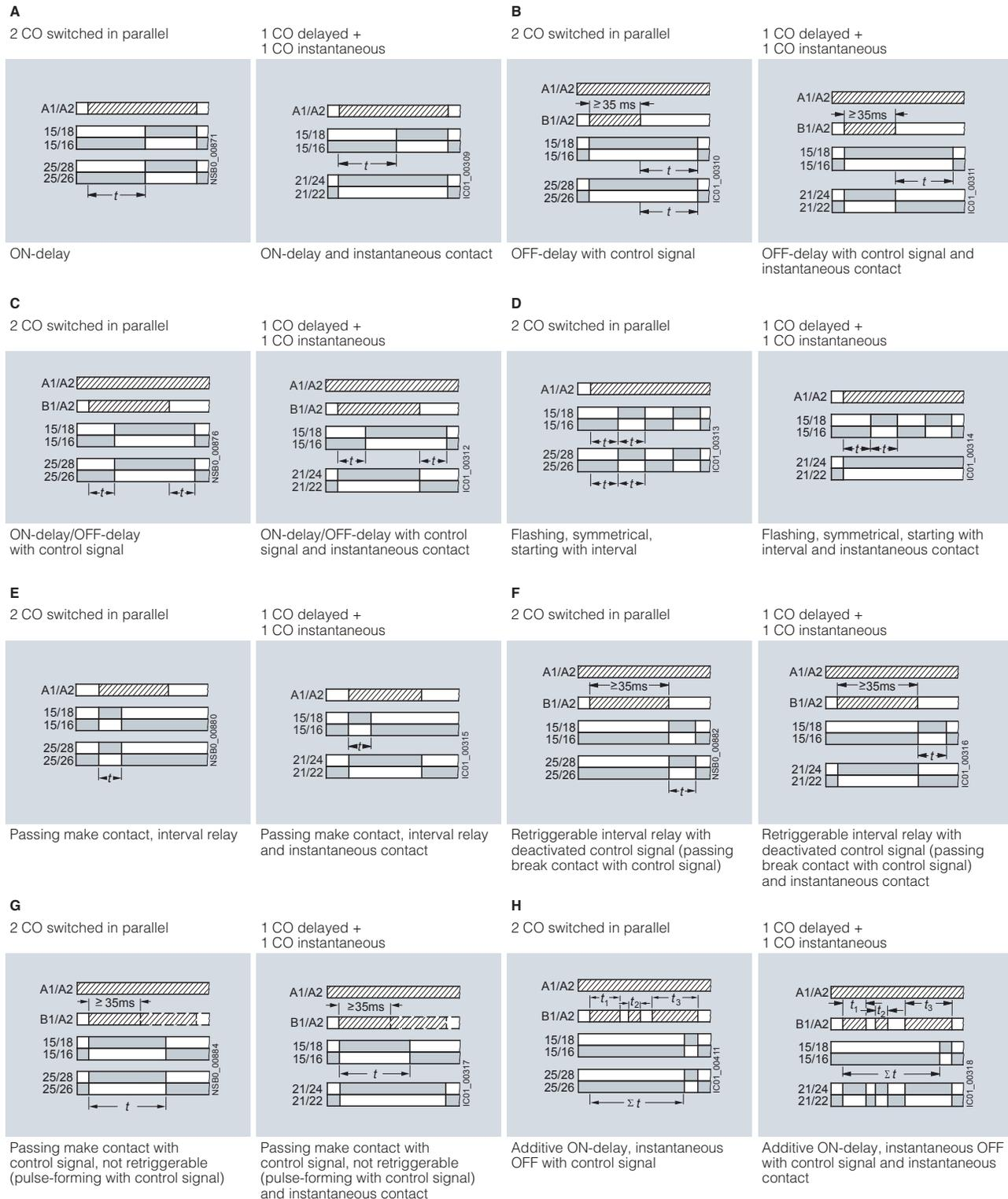

Legend

- A ... M** Identification letters
- Timing relay energized
- Contact closed
- Contact open

Multifunction 3RP2505-.B, 27 functions, 2 CO (continued)

I

2 CO switched in parallel

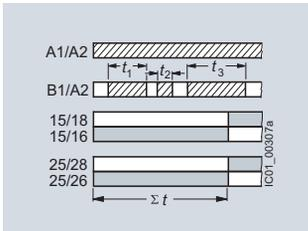

Additive ON-delay with control signal

1 CO delayed +
1 CO instantaneous

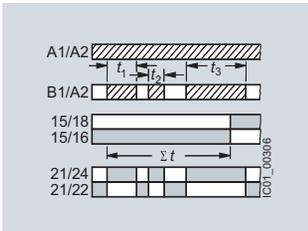

Additive ON-delay with control signal and instantaneous contact

J

2 CO switched in parallel

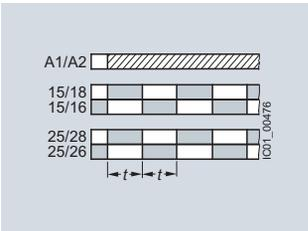

Flashing, symmetrical, starting with pulse

1 CO delayed +
1 CO instantaneous

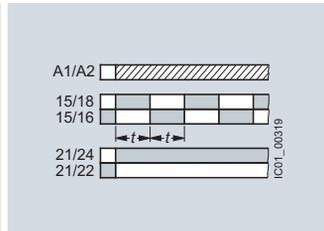

Flashing, symmetrical, starting with pulse and instantaneous contact

K

2 CO switched in parallel

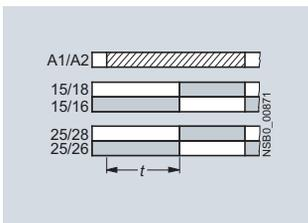

Pulse-delayed (fixed pulse at 1 s and settable pulse delay)

1 CO delayed +
1 CO instantaneous

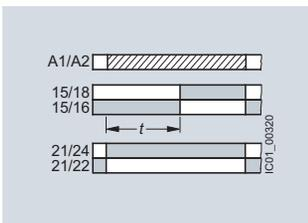

Pulse-delayed (fixed pulse at 1 s and settable pulse delay) and instantaneous contact

L

2 CO switched in parallel

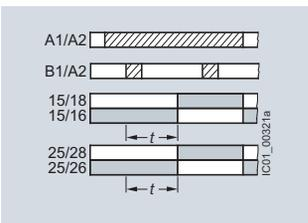

Pulse-delayed with control signal (fixed pulse at 1 s and settable pulse delay)

1 CO delayed +
1 CO instantaneous

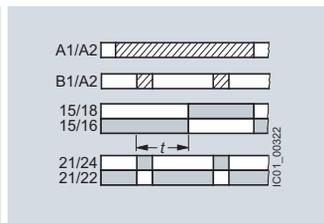

Pulse-delayed with control signal (fixed pulse at 1 s and settable pulse delay) and instantaneous contact

M

2 CO switched in parallel

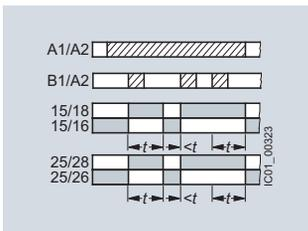

Retriggerable interval relay with activated control signal (watchdog)

1 CO delayed +
1 CO instantaneous

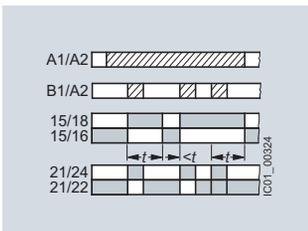

Retriggerable interval relay with activated control signal and instantaneous contact (watchdog)

ΥΔ

2 CO switched in parallel or 1 CO delayed +
1 CO instantaneous

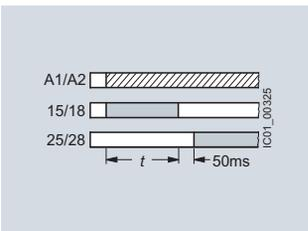

Wye-delta function

Legend

- A ... M** Identification letters
- ▨ Timing relay energized
- Contact closed
- Contact open

Timing Relays

3RP25 timing relays, 17.5 mm and 22.5 mm

Monofunctions 3RP251.. up to 3RP257.¹⁾

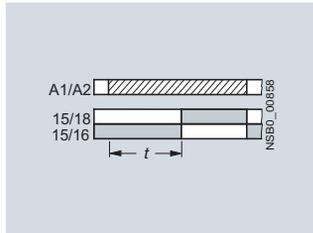

3RP251..AW30, 1 CO, ON-delay

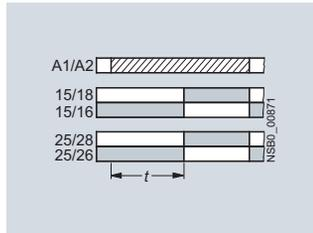

3RP2525..W30, 2 CO, ON-delay

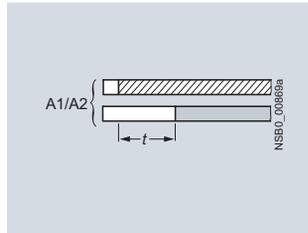

3RP2527..EW30, 1 NO (semiconductor), ON-delay

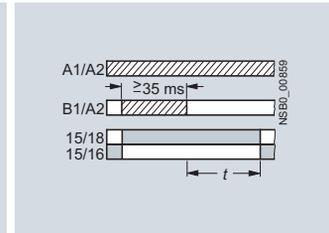

3RP2535..AW30, 1 CO, OFF-delay with control signal

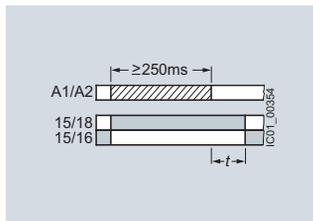

3RP2540..A.30, 1 CO, OFF-delay (N)¹⁾

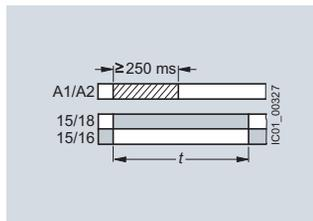

3RP2540..A.30, 1 CO, positive passing make contact (O)¹⁾

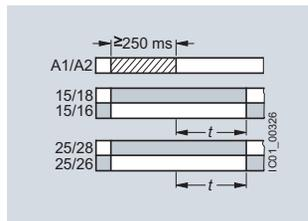

3RP2540..B.30, 2 CO, OFF-delay (N)¹⁾

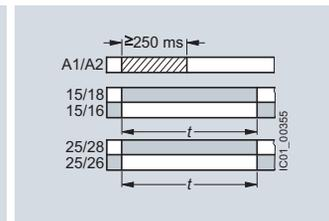

3RP2540..B.30, 2 CO, positive passing make contact (O)¹⁾

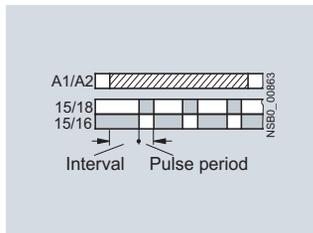

3RP2555..AW30, 1 CO, flashing, asymmetrical, starting with interval (clock-pulse relay)

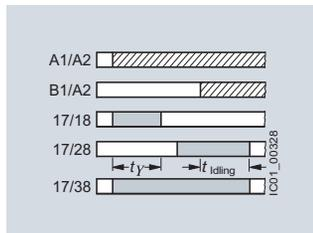

3RP2560..SW30, 3 NO, wye-delta function with overtravel function (idling)

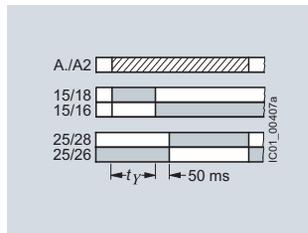

3RP257..NM20, 2 NO, wye-delta function

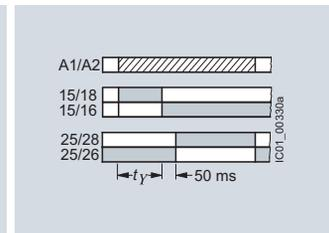

3RP257..NM30, 2 NO, wye-delta function

Legend

- Timing relay energized
- Contact closed
- Contact open

¹⁾ 3RP2540 has a double function:
Function N = OFF-delay
Function O = positive passing make contact.

Timing Relays

3RP25 timing relays, 17.5 mm and 22.5 mm

Possibilities of operation of the 3RP2560-.SW30 timing relay

Operation 1: Start contact B./A2 is open when control supply voltage A./A2 is applied

The control supply voltage is applied to A./A2 and there is no control signal on B./A2. This starts the $\Upsilon\Delta$ timing. The idling time (coasting time) is started by applying a control signal to B./A2. When the set time t_{idling} (30 ... 600 s) has elapsed, the output relays (17/38 and 17/28) are reset. If the control signal on B./A2 is switched off (minimum OFF period 270 ms), a new timing is started.

Note:

Observe response time (dead time) of 400 ms on energizing control supply voltage until contacts 17/18 and 17/16 close.

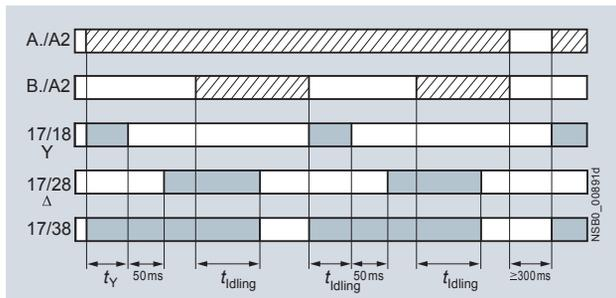

Operation 1

Operation 2: Start contact B./A2 is closed when control supply voltage A./A2 is applied

If the control signal B./A2 is already present when the control supply voltage A./A2 is applied, **no** timing is started. The timing is only started when the control signal B./A2 is switched off.

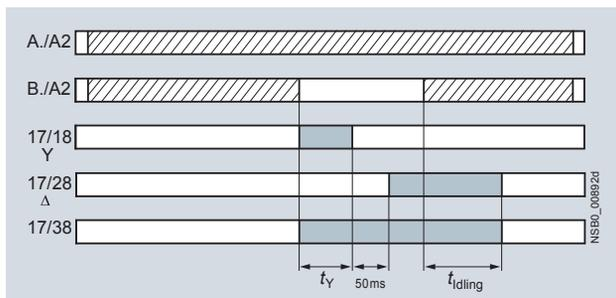

Operation 2

Operation 3: Start contact B./A2 closes while star time is running

If the control signal B./A2 is applied again during the star time, the idling time starts and the timing is terminated normally.

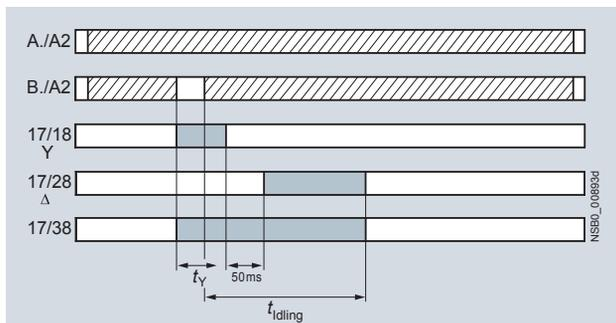

Operation 3

Operation 4: Start contact B./A2 opens while delta time is running and is applied again

If the control signal on B./A2 is applied and switched off again during the delta time, although the idling time has not yet elapsed, the idling time (coasting time) is reset to zero. If the control signal is re-applied to B./A2, the idling time is restarted.

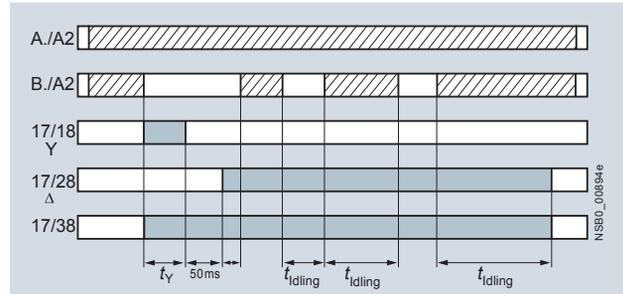

Operation 4

Legend

- Timing relay energized
- Contact closed
- Contact open

t_Y = Star time 1 ... 20 s

t_{idling} = Idling time (coasting time) 30 ... 600 s

Note:

The following applies to all operations: The pressure switch controls the timing via B./A2.

Application example based on standard operation (operation 1): For example, use of 3RP2560 for compressor control

Frequent starting of compressors strains the network, the machine, and the increased costs for the operator. The new timing relay prevents frequent starting at times when there is high demand for compressed air. A special control circuit prevents the compressor from being switched off immediately when the required air pressure in the tank has been reached. Instead, the valve in the intake tube is closed and the compressor runs in "Idling" mode, i.e. in no-load operation for a specific time which can be set from 30 ... 600 s.

If the pressure falls within this time, the motor does not have to be restarted again, but can return to nominal load operation from no-load operation.

If the pressure does not fall within this idling time, the motor is switched off.

The pressure switch controls the timing via B./A2.

The control supply voltage is applied to A./A2 and the start contact B./A2 is open, i.e. there is no control signal on B./A2 when the control supply voltage is applied. The pressure switch signals "too little pressure in system" and starts the timing by way of terminal B./A2. The compressor is started, enters $\Upsilon\Delta$ operation, and fills the pressure tank.

When the pressure switch signals "sufficient pressure", the control signal B./A2 is applied, the idling time (coasting time) is started, and the compressor enters no-load operation for the set period of time from 30 ... 600 s. The compressor is then switched off. The compressor is only restarted if the pressure switch responds again (low pressure).

Timing Relays

3RP25 timing relays, 17.5 mm and 22.5 mm

Selection and ordering data



PU (UNIT, SET, M)= 1
PS* = 1 unit

Number of NO contacts		Number of CO contacts		Semi-conduc-tor output	Adjustable time	Control supply voltage		DT	Screw terminals		DT	Spring-type terminals (push-in)	
Instan-taneous switch-ing	De-layed switch-ing	Instan-taneous switch-ing	De-layed switch-ing			At AC 50/60 Hz	At DC		Article No.	Price per PU		Article No.	Price per PU
						V	V						

3RP2505-.A and 3RP2505-.C timing relays, 13 functions

The functions can be adjusted by means of function selector switches on the device. With a set of foil labels the timing relay can be legibly marked with the functions which can be selected on the timing relay. This is supplied together with the multifunctional timing relay. The same potential must be applied to terminals A. and B. Functions, [see the overview functions on page 11/26](#).

0	0	0	1	--	0.05 s ... 100 h	24	24	A	3RP2505-1AB30	A	3RP2505-2AB30
					12 ... 240	12 ... 240	240 A		3RP2505-1AW30	A	3RP2505-2AW30
0	1	0	0	✓	0.05 s ... 100 h	12 ... 240	12 ... 240 A		3RP2505-1CW30	A	3RP2505-2CW30

3RP2505-.R timing relays suitable for railway applications, 13 functions

Start of delivery planned for 11/2015

The functions can be adjusted by means of function selector switches on the device. With a set of foil labels the timing relay can be legibly marked with the functions which can be selected on the timing relay. This is supplied together with the multifunctional timing relay. The same potential must be applied to terminals A. and B. Functions, [see the overview functions on page 11/26](#).

0	0	--	2 ¹⁾	--	0.05 s ... 100 h	24 ... 240	24 ... 240 A		3RP2505-1RW30	A	3RP2505-2RW30
---	---	----	-----------------	----	------------------	------------	--------------	--	----------------------	---	----------------------

3RP2505-.B timing relay, 27 functions

The functions can be adjusted by means of function selector switches on the device. With a set of foil labels the timing relay can be legibly marked with the functions which can be selected on the timing relay. This is supplied together with the multifunctional timing relay. The same potential must be applied to terminals A. and B. Functions, [see the overview functions on page 11/26](#).

0	0	--	2 ²⁾	--	0.05 s ... 100 h	24	24	A	3RP2505-1BB30	A	3RP2505-2BB30
					400 ... 440	--	--	A	3RP2505-1BT20	A	3RP2505-2BT20
					12 ... 240	12 ... 240 A			3RP2505-1BW30	A	3RP2505-2BW30

3RP251. and 3RP252. timing relays, ON-delay

0	0	0	1	--	0.5 ... 10 s	12 ... 240	12 ... 240 A		3RP2511-1AW30	A	3RP2511-2AW30
					1 ... 30 s	12 ... 240	12 ... 240 A		3RP2512-1AW30	A	3RP2512-2AW30
					5 ... 100 s	12 ... 240	12 ... 240 A		3RP2513-1AW30	A	3RP2513-2AW30
					0.05 s ... 100 h	12 ... 240	12 ... 240 A		3RP2525-1AW30	A	3RP2525-2AW30
0	0	0	2	--	0.05 s ... 100 h	24	24	A	3RP2525-1BB30	A	3RP2525-2BB30
					12 ... 240	12 ... 240 A			3RP2525-1BW30	A	3RP2525-2BW30
0	1	0	0	✓	0.05 s ... 240 s	12 ... 240	12 ... 240 A		3RP2527-1EW30	A	3RP2527-2EW30

3RP2535 timing relays, OFF-delay with control signal

0	0	0	1	--	0.05 s ... 100 h	12 ... 240	12 ... 240 A		3RP2535-1AW30	A	3RP2535-2AW30
---	---	---	---	----	------------------	------------	--------------	--	----------------------	---	----------------------

3RP2540 timing relays, OFF-delay, without control signal, non-volatile, passing make contact

0	0	0	1	--	0.05 s ... 600 s	24	24	A	3RP2540-1AB30	A	3RP2540-2AB30
					12 ... 240	12 ... 240 A			3RP2540-1AW30	A	3RP2540-2AW30
0	0	0	2	--	0.05 s ... 600 s	24	24	A	3RP2540-1BB30	A	3RP2540-2BB30
					12 ... 240	12 ... 240 A			3RP2540-1BW30	A	3RP2540-2BW30

3RP2555 timing relays, clock-pulse relay, flashing, asymmetrical

0	0	0	1	--	0.05 s ... 100 h	12 ... 240	12 ... 240 A		3RP2555-1AW30	A	3RP2555-2AW30
---	---	---	---	----	------------------	------------	--------------	--	----------------------	---	----------------------

3RP2560 timing relays, wye-delta function with overtravel function (idling)

1	2	0	0	--	1 ... 20 s	12 ... 240	12 ... 240 A		3RP2560-1SW30	A	3RP2560-2SW30
---	---	---	---	----	------------	------------	--------------	--	----------------------	---	----------------------

3RP257. timing relays, wye-delta function

1	1	0	0	--	1 ... 20 s	380 ... 440 ³⁾	--	A	3RP2574-1NM20	A	3RP2574-2NM20
					12 ... 240	12 ... 240			3RP2574-1NW30	A	3RP2574-2NW30
1	1	0	0	--	3 ... 60 s	380 ... 440 ³⁾	--	A	3RP2576-1NM20	A	3RP2576-2NM20
					12 ... 240	12 ... 240			3RP2576-1NW30	A	3RP2576-2NW30

✓ Available

-- Not available

1) Positively-driven contacts.

2) Optionally 1 CO delayed + 1 CO instantaneous.

3) With 3RP2574-.NM20 and 3RP2576-.NM20, connection of 200 ... 240 V AC, 50/60 Hz control voltage is also possible.

For accessories, [see page 11/41](#).

Timing Relays

3RP25 timing relays, 17.5 mm and 22.5 mm

Accessories

Version	DT	Article No.	Price per PU	PU (UNIT, SET, M)	PS*
Accessories for enclosures					
Sealing covers					
 3ZY1321-1AA00	• 17.5 mm	A	3ZY1321-1AA00	1	5 units
 3ZY1321-2AA00	• 22.5 mm	A	3ZY1321-2AA00	1	5 units
 3ZY1311-0AA00	Push-in lugs For wall mounting	A	3ZY1311-0AA00	1	10 units
 3ZY1440-0AA00	Coding pins For removable terminals of SIRIUS devices in the industrial standard mounting rail enclosure; enable the mechanical coding of terminals	A	3ZY1440-1AA00	1	12 units
Terminals for SIRIUS devices in the industrial standard mounting rail enclosure					
 3ZY1122-1BA00	Removable terminals • 2-pole, screw terminals 1 x 4 mm ²	A	Screw terminals 3ZY1122-1BA00	1	6 units
 3ZY1122-2BA00	• 2-pole, push-in terminals 1 x 4 mm ²	A	Spring-type terminals (push-in) 3ZY1122-2BA00	1	6 units
Tools for opening spring-type terminals					
 3RA2908-1A	Screwdrivers For all SIRIUS devices with spring-type terminals; 3,0 mm x 0.5 mm; length approx. 200 mm, titanium gray/black, partially insulated	A	Spring-type terminals 3RA2908-1A	1	1 unit

Timing Relays

3RP20 timing relays, 45 mm

Overview

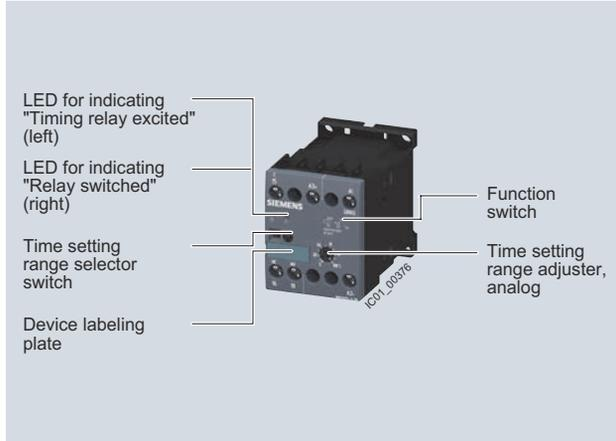

SIRIUS 3RP20 timing relays

SIRIUS 3RP20 electronic timing relays for use in control systems and mechanical engineering with:

- 1 or 2 CO contacts
- Multifunction or monofunction
- Wide voltage range or combination voltage
- Single or selectable time setting ranges
- Switch position indication and voltage indication by LED

Standards

The timing relays comply with:

- IEC 60721-3-3 "Classification of environmental conditions"
- IEC 61812-1 "Time relays for industrial and residential use"
- IEC 61000-6-2 and EN 61000-6-4 "Electromagnetic compatibility"
- IEC 60947-5-1 "Low-voltage switchgear and controlgear – Electromechanical control circuit devices"
- IEC 60947-1, Appendix N "Protective separation"

Multifunction

The functions of the 3RP2005 multifunctional timing relays can be set by means of the function selector switch. Insert labels can be used to adjust different functions of the timing relay clearly and unmistakably. The corresponding labels can be ordered as an accessory. The same potential must be applied to terminals A. and B.

For functions, see 3RP2901 label set, page 11/47.

Note:

The activation of loads parallel to the start input is not permissible when using AC control voltage (see diagrams).

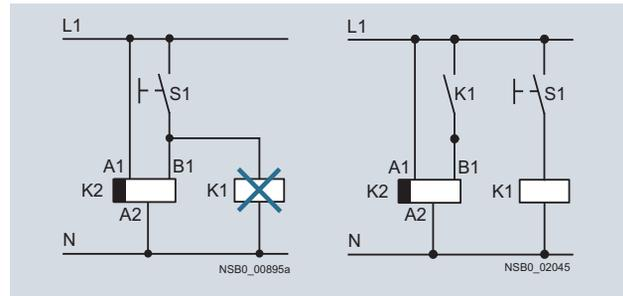

Diagrams

Accessories

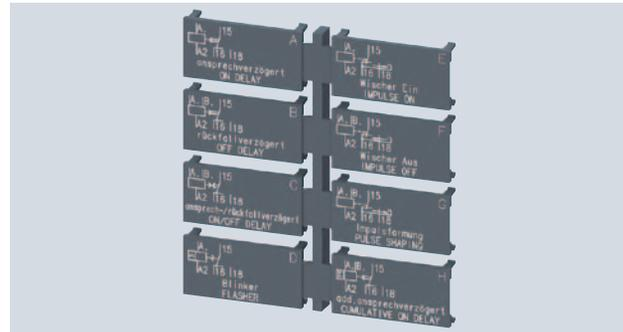

Label set for marking the multifunctional relay

Article No. scheme

Digit of the Article No.	1st - 5th	6th	7th	8th	9th	10th	11th	12th
	□□□□□	□	□	-	□	□	□	0
SIRIUS timing relays, enclosure 45 mm	3 R P 2 0							
Functions/time setting ranges		□	□					
Connection type					□			
Contacts						□		
Rated control supply voltage							□	□
Example	3 R P 2 0 5 - 1 A P 3 0							

Note:

The Article No. scheme is presented here merely for information purposes and for better understanding of the logic behind the article numbers.

For your orders, please use the article numbers quoted in the catalog in the Selection and ordering data.

Benefits

- Suitable for 3RT miniature contactors
- Uniform design
- Ideal for small distance between standard mounting rails and/or for low mounting depth, e.g. in control boxes
- Labels are used on the multifunctional time relay to document the function that has been set

Timing Relays

3RP20 timing relays, 45 mm

Application

Timing relays are used in control, starting, and protective circuits for all switching operations involving time delays. They guarantee a high level of functionality and a high repeat accuracy of timer settings.

Technical specifications

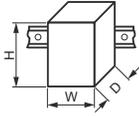
Type	3RP2005, 3RP2025	
Dimensions (W x H x D)		mm 45 x 57 x 73
Rated insulation voltage Pollution degree 3 Overvoltage category III	V AC	300
Permissible ambient temperature • During operation • During storage	°C	-25 ... +60 -40 ... +85
Operating range at excitation¹⁾		0.85 ... 1.1 x U _s at AC; 0.8 ... 1.25 x U _s at DC; 0.95 ... 1.05 times the rated frequency
Mechanical endurance	Operating cycles	10 x 10 ⁶
Electrical endurance at I₆	Operating cycles	1 x 10 ⁵
Connection type	 Screw terminals	
• Terminal screw • Solid • Finely stranded with end sleeve • Stranded • AWG cables • Tightening torque	mm ² mm ² AWG AWG Nm	M3 (for standard screwdriver, size 2 and Pozidriv 2) 2 x (0.5 ... 1.5) ²⁾ , 2 x (0.75 ... 2.5) ²⁾ 2 x (0.5 ... 1.5) ²⁾ , 2 x (0.75 ... 2.5) ²⁾ 2 x (0.5 ... 1.5) ²⁾ , 2 x (0.75 ... 2.5) ²⁾ 2 x (18 ... 14) 0.8 ... 1.2
Connection type	 Spring-type terminals	
• Solid • Finely stranded with end sleeve • Finely stranded without end sleeve • AWG cables, solid or stranded • Max. external diameter of the conductor insulation	mm ² mm ² mm ² AWG mm	2 x (0.25 ... 2.5) 2 x (0.25 ... 1.5) 2 x (0.25 ... 2.5) 2 x (24 ... 14) 3.6

¹⁾ If nothing else is stated.

²⁾ If two different conductor cross-sections are connected to one clamping point, both cross-sections must lie in one of the ranges specified.

3RP20 internal circuit diagrams

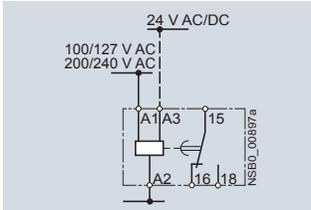
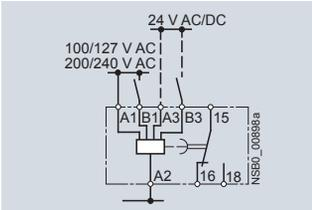
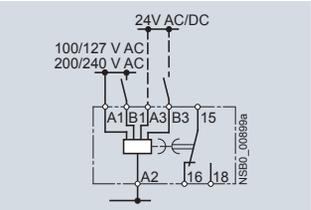
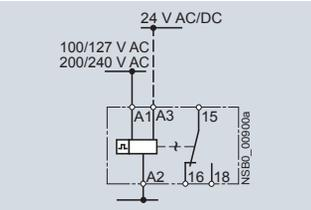
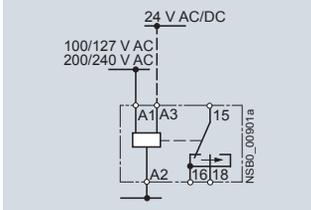
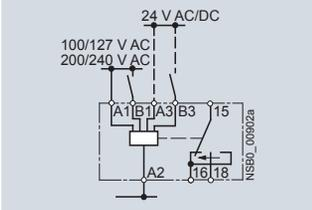
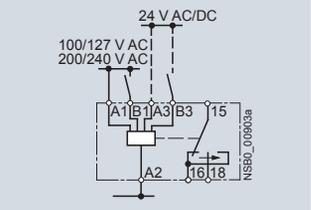
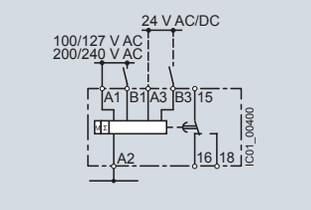
			
3RP2005, 3RP2025 ON-delay	3RP2005 OFF-delay with control signal	3RP2005 ON-delay and OFF-delay with control signal	3RP2005 Flashing, starting with interval
			
3RP2005 Passing make contact	3RP2005 Passing break contact with control signal	3RP2005 Pulse-forming with control signal	3RP2005 Additive ON-delay with control signal

3RP20 function diagrams and 3RP2901 label set

1 CO contact

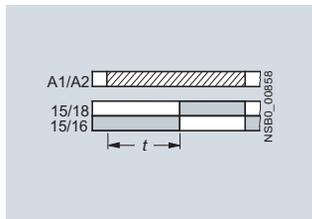

A
3RP2005-.A, 3RP2025
ON-delay

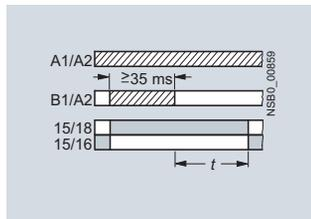

B¹⁾
3RP2005-.A
OFF-delay with control signal

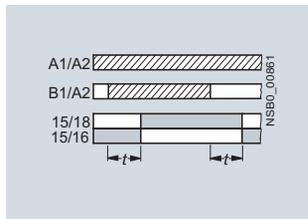

C¹⁾
3RP2005-.A
ON-delay and OFF-delay
with control signal ($t = t_{on} = t_{off}$)

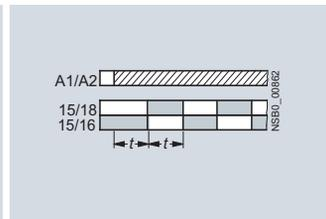

D
3RP2005-.A
Flashing, starting with interval
(pulse/interval 1:1)

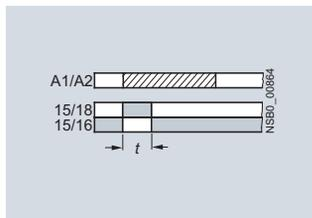

E
3RP2005-.A
Passing make contact

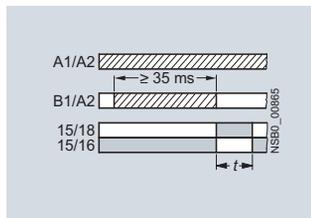

F¹⁾
3RP2005-.A
Passing break contact
with control signal

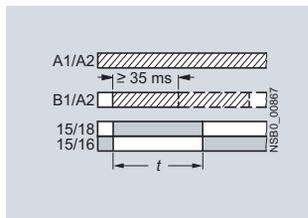

G¹⁾
3RP2005-.A
Pulse-forming with control signal
(pulse generation at the output does
not depend on duration of energizing)

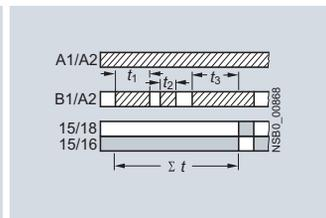

H¹⁾
3RP2005-.A
Additive ON-delay with control signal

Legend

A ... H Identification letters for 3RP2005

Timing relay energized

Contact closed

Contact open

¹⁾ Note on function with start contact: A new control signal at terminal B, after the operating time has started, resets the operating time to zero (retriggerable). This does not apply to G, G● and H●, which are not retriggerable.

Timing Relays

3RP20 timing relays, 45 mm

2 CO contacts

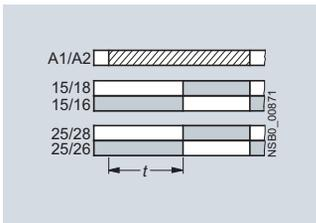

A
3RP2005-B
ON-delay

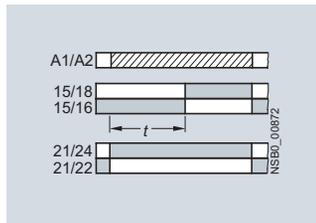

A•
3RP2005-B
ON-delay and instantaneous contact

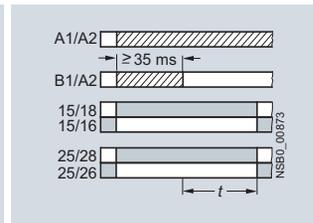

B¹⁾
3RP2005-B
OFF-delay with control signal

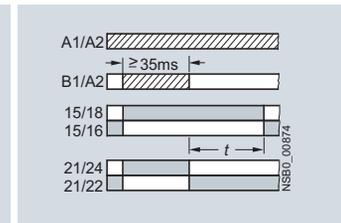

B•¹⁾
3RP2005-B
OFF-delay with control signal and instantaneous contact

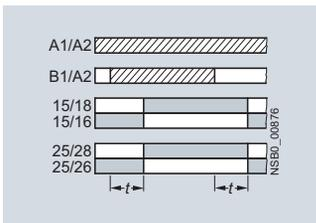

C¹⁾
3RP2005-B
ON-delay and OFF-delay with control signal ($t = t_{on} = t_{off}$)

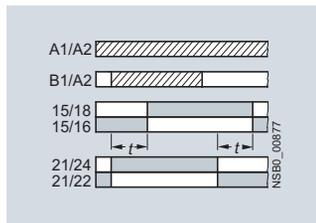

C•¹⁾
3RP2005-B
ON-delay and OFF-delay with control signal and instantaneous contact ($t = t_{on} = t_{off}$)

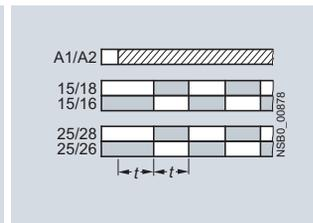

D
3RP2005-B
Flashing, starting with interval (pulse/interval 1:1)

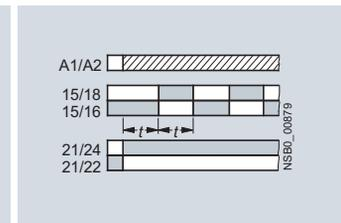

D•
3RP2005-B
Flashing, starting with interval (pulse/interval 1:1) and instantaneous contact

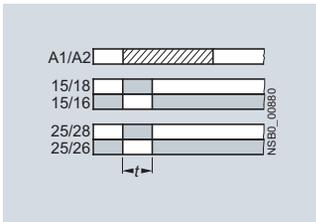

E
3RP2005-B
Passing make contact

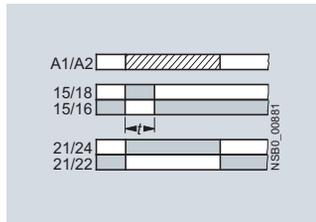

E•
3RP2005-B
Passing make contact and instantaneous contact

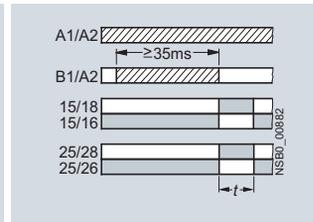

F¹⁾
3RP2005-B
Passing break contact with control signal

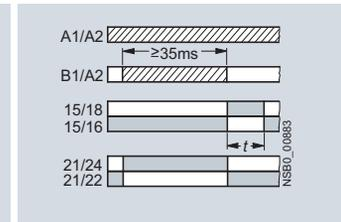

F•¹⁾
3RP2005-B
Passing break contact with control signal and instantaneous contact

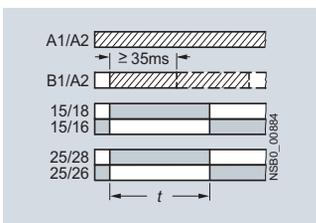

G¹⁾
3RP2005-B
Pulse-forming with control signal (pulse generation at the output does not depend on duration of energizing)

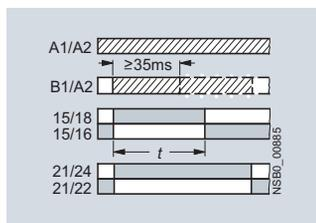

G•¹⁾
3RP2005-B
Pulse-forming with control signal and instantaneous contact (pulse generation at the output does not depend on duration of energizing)

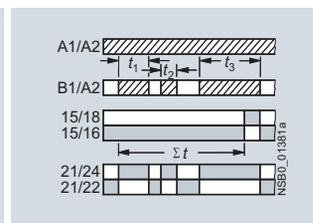

H•¹⁾
3RP2005-B
Additive ON-delay with control signal and instantaneous contact

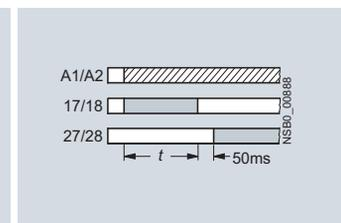

YΔ
3RP2005-B
Wye-delta function

Legend

A ... H Identification letters for 3RP2005

- ▨ Timing relay energized
- Contact closed
- Contact open

¹⁾ Note on function with start contact: A new control signal at terminal B, after the operating time has started, resets the operating time to zero (retriggerable). This does not apply to G, G• and H•, which are not retriggerable.

Timing Relays

3RP20 timing relays, 45 mm

Accessories

Version	Function	Identifi- cation letter	Use	DT	Article No.	Price per PU	PU (UNIT, SET, M)	PS*
---------	----------	-------------------------------	-----	----	-------------	-----------------	-------------------------	-----

Label sets for 3RP20

Accessories for 3RP20 (not included in the scope of supply).
The label set offers the possibility of labeling timing relays
with the set function in English and German.

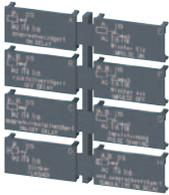

3RP2901-0A

1 label set (1 unit) with 8 functions	ON-delay	A	For devices with 1 CO	C	3RP2901-0A		1	5 units
	OFF-delay with control signal	B						
	ON-delay and OFF-delay with control signal	C						
	Flashing, starting with interval	D						
	Passing make contact	E						
	Passing break contact with control signal	F						
	Pulse-forming with control signal	G						
	Additive ON-delay with control signal	H						



3RP2901-0B

1 label set (1 unit) with 16 functions	ON-delay	A	For devices with 2 CO contacts	C	3RP2901-0B		1	5 units
	OFF-delay with control signal	B						
	ON-delay and OFF-delay with control signal	C						
	Flashing, starting with interval	D						
	Passing make contact	E						
	Passing break contact with control signal	F						
	Pulse-forming with control signal	G						
	ON-delay and instantaneous contact	A•						
	OFF-delay with control signal and instantaneous contact	B•						
	ON-delay and OFF-delay with control signal and instantaneous contact	C•						
	Flashing, starting with interval, and instantaneous contact	D•						
	Passing make contact and instan- taneous contact	E•						
	Passing break contact with control signal and instantaneous contact	F•						
	Pulse-forming with control signal and instantaneous contact	G•						
	Additive ON-delay with control signal and instantaneous contact	H•						
	Wye-delta function	YΔ						

Blank inscription labels for 3RP20

Blank labels, 20 mm x 7 mm, pastel turquoise			For 3RP20	D	3RT1900-1SB20		100	340 units
---	--	--	-----------	---	----------------------	--	-----	-----------

Timing Relays

7PV15 timing relays in enclosure, 17.5 mm

Overview



7PV15 timing relay

Electronic timing relays for general use and in control systems, mechanical engineering and infrastructure with:

- 1 or 2 CO contacts
- Multifunction or monofunction
- Wide voltage range or combination voltage
- Single or selectable time setting ranges
- Switch position indication and voltage indication by LED

Standards

The timing relays comply with:

- IEC 60721-3-3 "Classification of environmental conditions"
- IEC 61812-1 "Time relays for industrial and residential use"
- IEC 61000-6-2 and EN 61000-6-4 "Electromagnetic compatibility"
- IEC 60947-5-1 "Low-voltage switchgear and controlgear – Electromechanical control circuit devices"
- DIN 43880 "Built-in equipment for electrical installations; overall dimensions and related mounting dimensions"

Multifunction

The functions of the 7PV1508-1A multifunctional timing relays can be set by means of rotary switches. The identification letters A to G are printed on the front alongside the rotary selector switch of the unit. The related function can be found in the form of a bar graph on the side of the device.

Enclosure version

All timing relays are suitable for snap-on mounting onto TH 35 standard mounting rails according to IEC 60715. The enclosure complies with DIN 43880, 1 MW.

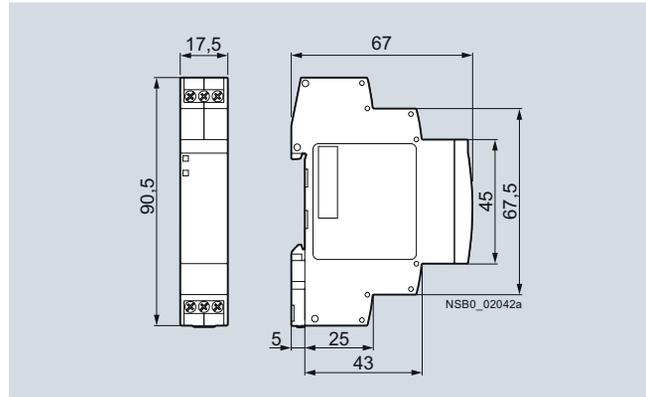

Dimensions

Note:

The activation of loads parallel to the start input is not permissible when using AC control voltage (see diagrams).

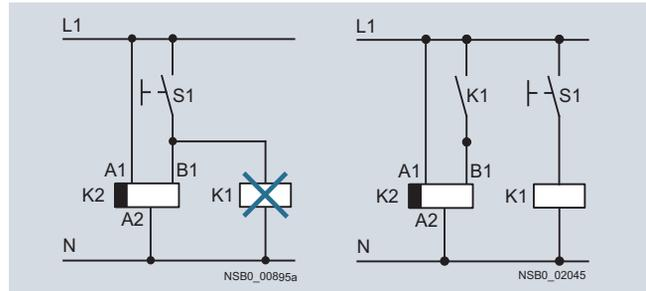

Diagrams

Article No. scheme

Digit of the Article No.	1st - 5th	6th	7th	8th	9th	10th	11th	12th
	□□□□□	□	□	-	□	□	□	0
Timing relays in industrial enclosure, 17.5 mm	7 P V 1 5							
Functions/time setting ranges	□	□						
Connection type				□				
Contacts					□			
Rated control supply voltage						□	□	
Example	7 P V 1 5	0	8	-	1	A	W	3 0

Note:

The Article No. scheme is presented here merely for information purposes and for better understanding of the logic behind the article numbers.

For your orders, please use the article numbers quoted in the catalog in the Selection and ordering data.

Timing Relays

7PV15 timing relays in enclosure, 17.5 mm

Benefits

- Wide voltage range 12 to 240 V AC/DC
- High switching capacity, e.g. AC-15 at 230 V, 3 A
- Combination voltage, e.g. 24 V AC/DC and 200 to 240 V AC
- Changes to the time setting range during operation
- Changes to the function in the de-energized state
- High level of functionality and a high repeat accuracy of timer settings
- Integrated surge suppressor
- Function charts printed on the side of the device for reliable device adjustment

Application

Timing relays are used in control, starting and protective circuits for all switching operations involving time delays, e.g. in non-residential buildings, airports, industrial buildings etc.

Technical specifications

Type		7PV15
Rated insulation voltage Pollution degree 2, overvoltage category III	V AC	300
Permissible ambient temperature		
• During operation	°C	-25 ... +55
• During storage	°C	-40 ... +70
Operating range at excitation¹⁾		0.85 ... 1.1 x U_N at V AC/DC, 50/60 Hz 0.8 ... 1.25 x U_N 24 V DC 0.95 ... 1.05 times the rated frequency
Rated operational current I_b		
• AC-15 at 24 ... 240 V, 50 Hz	A	3
• DC-13 at		
- 24 V	A	1
- 125 V	A	0.2
Uninterrupted thermal current I_{th}	A	5
Mechanical endurance	Operating cycles	1 x 10 ⁶
Electrical endurance at I_b	Operating cycles	1 x 10 ⁵
Connection type		 Screw terminals
• Terminal screw		M3 (for standard screwdriver, size 2 and Pozidriv 2)
• Solid	mm ²	1 x (0.2 ... 2.5)
• Finely stranded with end sleeve	mm ²	1 x (0.25 ... 1.5)
• Finely stranded without end sleeve	mm ²	1 x (0.2 ... 1.5)
• AWG cables, solid or stranded	AWG	1 x (24 ... 14)
• Tightening torque	Nm	0.4 ... 0.5

¹⁾ If nothing else is stated.

7PV15 internal circuit diagrams

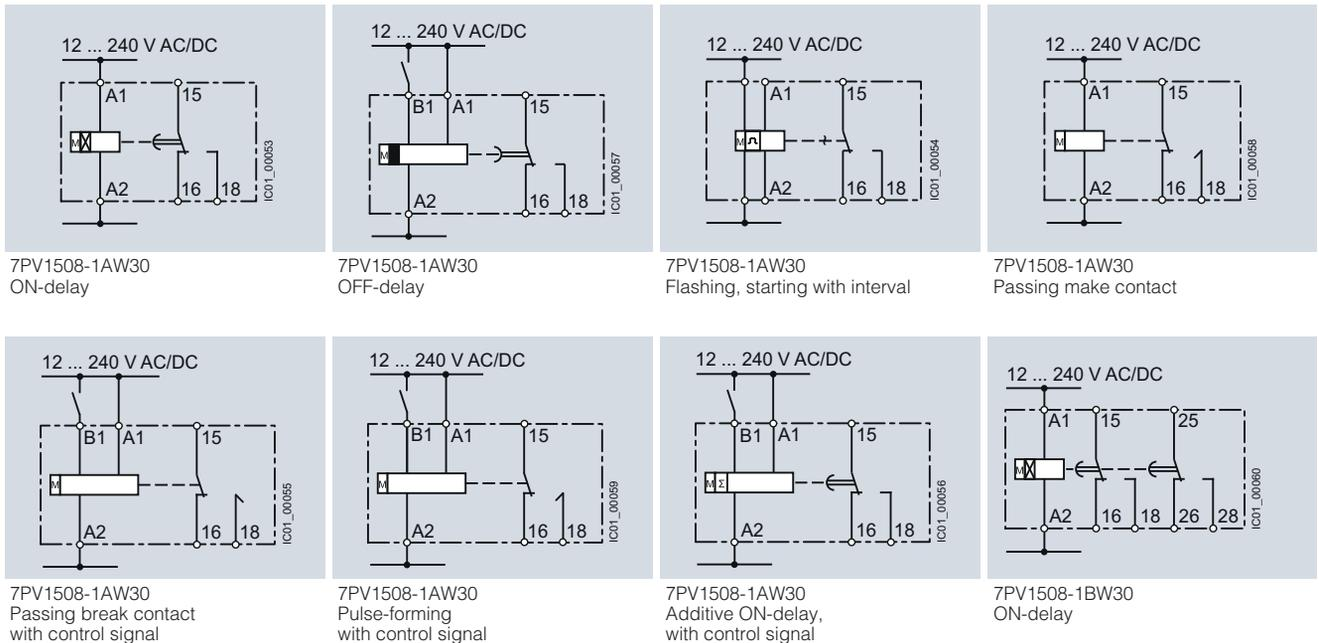

Timing Relays

7PV15 timing relays in enclosure, 17.5 mm

7PV15 internal circuit diagrams (continued)

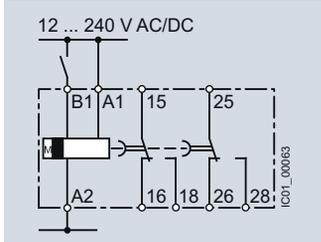

7PV1508-1BW30
OFF-delay
with control signal

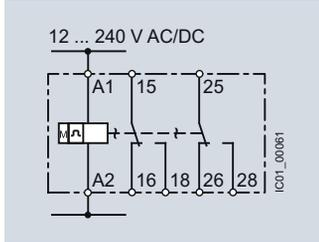

7PV1508-1BW30
Flashing,
starting with interval

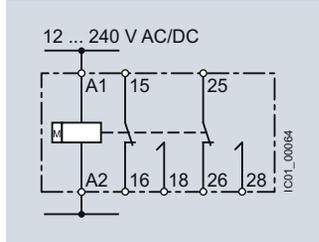

7PV1508-1BW30
Passing make contact

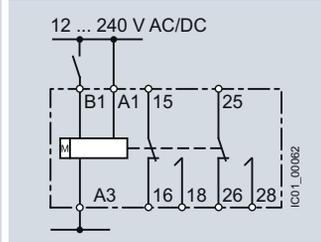

7PV1508-1BW30
Pulse-forming
with control signal

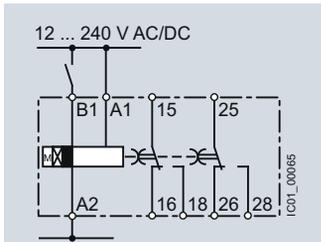

7PV1508-1BW30
ON and OFF-delay

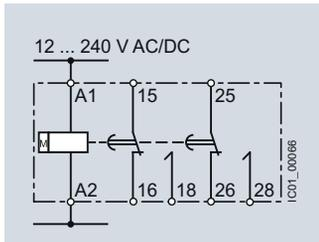

7PV1508-1BW30
Fixed pulse after ON-delay

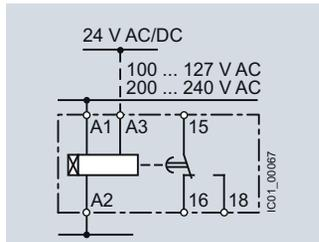

7PV151.-1AQ30, 7PV151.-1AP30
ON-delay

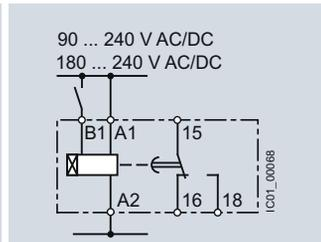

7PV1518-1AJ30, 7PV1518-1AN30
ON-delay

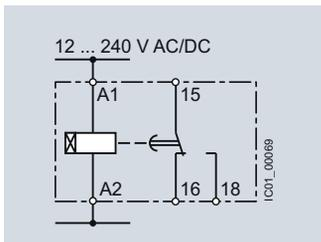

7PV1518-1AW30
ON-delay

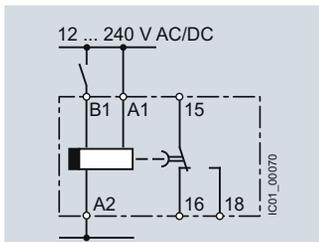

7PV1538-1AW30
OFF-delay
with control signal

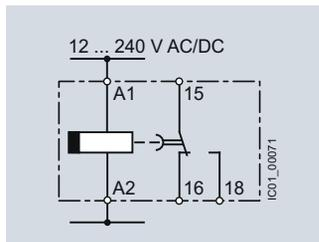

7PV1540-1AW30
OFF-delay
without control signal

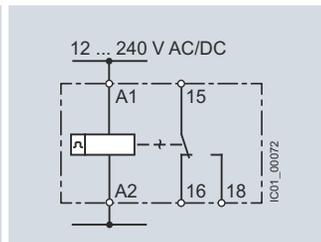

7PV1558-1AW30
Clock-pulse relay

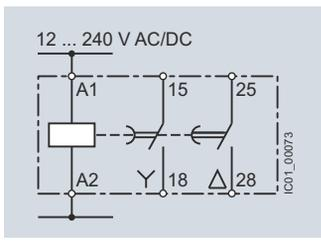

7PV1578-1BW30
Wye-delta

Timing Relays

7PV15 timing relays in enclosure, 17.5 mm

7PV15 function diagrams

1 CO contact

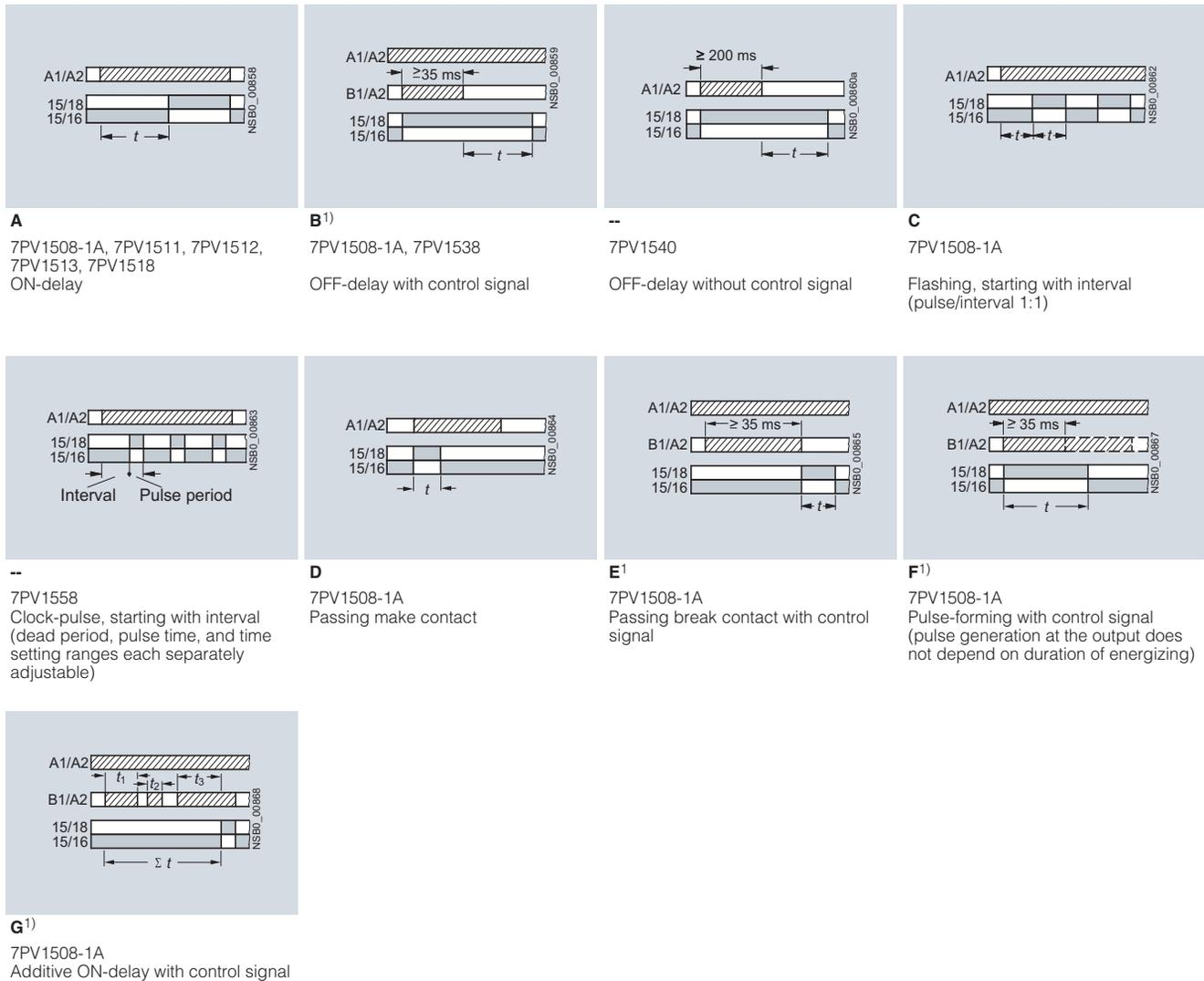

Legend

A ... G Identification letters for 7PV1508

▨ Timing relay energized

■ Contact closed

□ Contact open

¹⁾ Note on function with start contact: A new control signal at terminal B, after the operating time has started, resets the operating time to zero (retriggerable). This does not apply to E, F and G, which are not retriggerable.

Note:

With the 7PV1508-1A multifunctional relay the identification letters A to G are printed on the front alongside the rotary selector switch of the unit. The related function can be found in the form of a bar graph on the side of the device.

Timing Relays

7PV15 timing relays in enclosure, 17.5 mm

2 CO contacts

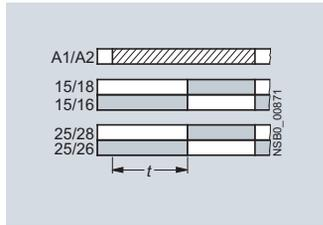

A
7PV1508-1B
ON-delay

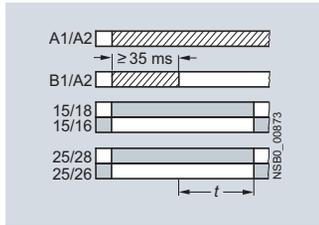

B¹⁾
7PV1508-1B
OFF-delay with control signal

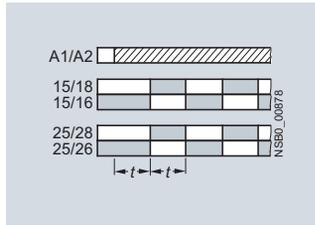

C
7PV1508-1B
Flashing, starting with interval
(pulse/interval 1:1)

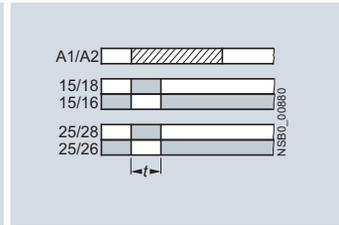

D
7PV1508-1B
Passing make contact

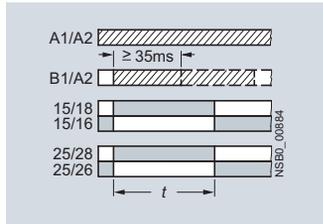

F¹⁾
7PV1508-1B
Pulse-forming with control signal
(pulse generation at the output does
not depend on duration of
energizing)

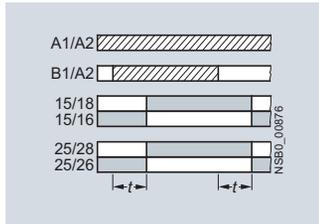

H¹⁾
7PV1508-1B
ON-delay and OFF-delay
with control signal

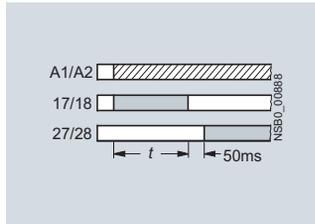

I
7PV1508-1B
Fixed pulse after ON-delay

2 NO contacts

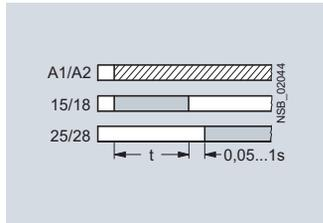

--
7PV1578
Wye-delta function²⁾

Legend

A ... D, F, H, I Identification letters for 7PV1508

- Timing relay energized
- Contact closed
- Contact open

¹⁾ Note on function with start contact: A new control signal at terminal B, after the operating time has started, resets the operating time to zero (retriggerable). This does not apply to E, F and G, which are not retriggerable.

²⁾ With 7PV1578 the contacts 16 and 26 are not needed for the wye-delta function.

Note:

With the 7PV1508-1B multifunctional relay the identification letters A to D, F, H, I are printed on the front alongside the rotary selector switch of the unit. The related function can be found in the form of a bar graph on the side of the device.

Timing Relays

7PV15 timing relays in enclosure, 17.5 mm

Selection and ordering data



Version	Time setting range t adjustable by rotary switch to	Rated control supply voltage U_s	DT	Screw terminals	PU (UNIT, SET, M)	PS*
		50/60 Hz AC V	DC V	Article No.	Price per PU	
7PV1508 timing relays, multifunction, 7 time setting ranges						
The functions can be adjusted by means of rotary switches. The same potential must be applied to terminals A. and B.						
With LED and 1 CO contact, 7 functions	0.05 ... 1 s 0.5 ... 10 s 5 ... 100 s	12 ... 240	12 ... 240	▶ 7PV1508-1AW30	1	1 unit
With LED and 2 CO contacts, 7 functions	30 s ... 10 min 3 min ... 1 h 30 min ... 10 h 5 ... 100 h	12 ... 240	12 ... 240	▶ 7PV1508-1BW30	1	1 unit
7PV151. timing relays, ON-delay, 1 time setting range						
With LED and 1 CO contact	0.05 ... 1 s	24/200 ... 240	24	▶ 7PV1511-1AP30	1	1 unit
	0.5 ... 10 s	24/100 ... 127	24	▶ 7PV1512-1AQ30	1	1 unit
		24/200 ... 240	24	▶ 7PV1512-1AP30	1	1 unit
	5 ... 100 s	24/100 ... 127	24	▶ 7PV1513-1AQ30	1	1 unit
		24/200 ... 240	24	▶ 7PV1513-1AP30	1	1 unit
7PV1518 timing relays, ON-delay, 7 time setting ranges						
With LED and 1 CO contact	0.05 ... 1 s	12 ... 240	12 ... 240	▶ 7PV1518-1AW30	1	1 unit
	0.5 ... 10 s	90 ... 127	90 ... 127	▶ 7PV1518-1AJ30	1	1 unit
	5 ... 100 s	180 ... 240	180 ... 240	▶ 7PV1518-1AN30	1	1 unit
	30 s ... 10 min 3 min ... 1 h 30 min ... 10 h 5 ... 100 h					
7PV1538 timing relays, OFF-delay, with control signal, 7 time setting range						
With LED and 1 CO contact	0.05 ... 1 s 0.5 ... 10 s 5 ... 100 s 30 s ... 10 min 3 min ... 1 h 30 min ... 10 h 5 ... 100 h	12 ... 240	12 ... 240	▶ 7PV1538-1AW30	1	1 unit
7PV1540 timing relays, OFF-delay, without control signal, 7 time setting ranges						
With LED and 1 CO contact	0.05 ... 1 s 0.15 ... 3s 0.3 ... 6 s 0.5 ... 10 s 1.5 ... 30 s 3 ... 60 s 5 ... 100 s	12 ... 240	12 ... 240	▶ 7PV1540-1AW30	1	1 unit
7PV1558 timing relays, clock-pulse relay, 7 time setting ranges						
With LED and 1 CO contact	0.05 ... 1 s 0.5 ... 10 s 5 ... 100 s 30 s ... 10 min 3 min ... 1 h 30 min ... 10 h 5 ... 100 h	12 ... 240	12 ... 240	▶ 7PV1558-1AW30	1	1 unit
7PV1578 timing relays, wye-delta function, 7 time setting ranges						
With LED and 2 NO contacts, dead interval 0.05 ... 1 s adjustable	0.05 ... 1 s 0.5 ... 10 s 5 ... 100 s 30 s ... 10 min 3 min ... 1 h 30 min ... 10 h 5 ... 100 h	12 ... 240	12 ... 240	▶ 7PV1578-1BW30	1	1 unit

3UG45, 3UG46 Monitoring Relays for Stand-Alone Installation

General data

Overview



SIRIUS 3UG4 monitoring relay

More information

Homepage, see www.usa.siemens.com/relays
 Industry Mall, see www.siemens.com/product?3UG45
 For the conversion tool, e.g. from 3UG3 to 3UG4, see www.siemens.com/sirius/conversion-tool

The field-proven SIRIUS monitoring relays for electrical and mechanical variables enable constant monitoring of all important characteristic quantities that provide information about the functional capability of a plant. Both sudden disturbances and gradual changes, which may indicate the need for maintenance, are detected. Thanks to their relay outputs, the monitoring relays permit direct disconnection of the affected system components as well as alerting (e.g. by switching a warning lamp).

Thanks to adjustable delay times the monitoring relays can respond very flexibly to brief faults such as voltage dips or load changes. This avoids unnecessary alarms and disconnections while enhancing plant availability.

The individual 3UG4 monitoring relays offer the following functions in various combinations:

- Undershooting and/or overshooting of liquid levels
- Phase sequence
- Phase failure, neutral conductor failure
- Phase asymmetry
- Undershooting and/or overshooting of limit values for voltage
- Undershooting and/or overshooting of limit values for current
- Undershooting and/or overshooting of limit values for power factor
- Monitoring of the active current or the apparent current
- Monitoring of the residual current
- Monitoring of the insulation resistance
- Undershooting and/or overshooting of limit values for speed

Article No. scheme

Product versions		Article number									
Monitoring relays		3UG4	<input type="checkbox"/>	<input type="checkbox"/>	<input type="checkbox"/>	<input type="checkbox"/>	<input type="checkbox"/>	<input type="checkbox"/>	<input type="checkbox"/>	<input type="checkbox"/>	0
Type of setting	e.g. 5 = analogically adjustable		<input type="checkbox"/>								
Functions	e.g. 11 = line monitoring		<input type="checkbox"/>	<input type="checkbox"/>							
Connection type	Screw terminals								1		
	Spring-type terminals								2		
Contacts	e.g. A = 1 CO contact									<input type="checkbox"/>	
Supply voltage	e.g. N2 = 160 ... 260 V AC									<input type="checkbox"/>	<input type="checkbox"/>
Example		3UG4	5	1	1	-	1	A	N	2	0

Note:

The Article No. scheme shows an overview of product versions for better understanding of the logic behind the article numbers.

For your orders, please use the article numbers quoted in the selection and ordering data.

General data

Benefits

- Customary screw and spring-type terminals for quick and reliable wiring
- Fast commissioning thanks to menu-guided parameterization and actual value display for limit value determination
- Reduced space requirement in the control cabinet thanks to a consistent width of 22.5 mm
- Parameterizable monitoring functions, delay times, RESET response, etc.
- Reduced stockkeeping thanks to minimized variance and large measuring ranges
- Wide-voltage power supply units for global applicability
- Device replacement without renewed wiring thanks to removable terminals
- Reliable system diagnostics thanks to actual value display and connectable fault memory
- Rapid diagnostics thanks to unambiguous error messages on the display

Application

The SIRIUS 3UG4 monitoring relays monitor the most diverse electrical and mechanical quantities in the feeder, and provide reliable protection against damage in the plant. For this purpose, they offer freely parameterizable limit values and diverse options for adapting to the respective task, and in the event of a fault, they provide clear diagnostics information.

The digitally adjustable products also display the current measured values direct on the device. This not only facilitates the display of valuable plant status information during operation, it also enables adjustment of the monitored limit values in accordance with the actual conditions.

The positive result: More selective avoidance of production faults – sustained increases in availability and productivity.

The 3UG4 monitoring relays are available for the following applications:

- Line and single-phase voltage monitoring
- Single-phase current monitoring or power factor and active current monitoring
- Residual current monitoring
- Insulation monitoring
- Level monitoring
- Speed monitoring

Technical specifications

More information

Technical specifications, see <https://support.industry.siemens.com/cs/ww/en/ps/16367/td>

FAQs, see <https://support.industry.siemens.com/cs/ww/en/ps/16367/faq>

Manual and internal circuit diagrams, see <https://support.industry.siemens.com/cs/ww/en/view/54397927>

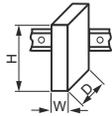
Type	3UG		
General data			
Dimensions (W x H x D)			
• For 2 terminal blocks		mm	22.5 x 83 x 91
- Screw terminals		mm	22.5 x 84 x 91
- Spring-type terminals			
• For 3 terminal blocks		mm	22.5 x 92 x 91
- Screw terminals		mm	22.5 x 94 x 91
- Spring-type terminals			
• For 4 terminal blocks	mm	22.5 x 103 x 91	
- Screw terminals	mm	22.5 x 103 x 91	
- Spring-type terminals			
Permissible ambient temperature			
• During operation	°C	-25 ... +60	
Connection type		 Screw terminals	
• Terminal screw		M3 (for standard screwdriver, size 2 and Pozidriv 2)	
• Solid	mm ²	1 x (0.5 ... 4)/2 x (0.5 ... 2.5)	
• Finely stranded with end sleeve	mm ²	1 x (0.5 ... 2.5)/2 x (0.5 ... 1.5)	
• AWG cables, solid or stranded	AWG	2 x (20 ... 14)	
Connection type		 Spring-type terminals	
• Solid	mm ²	2 x (0.25 ... 1.5)	
• Finely stranded, with end sleeve acc. to DIN 46228	mm ²	2 x (0.25 ... 1.5)	
• Finely stranded	mm ²	2 x (0.25 ... 1.5)	
• AWG cables, solid or stranded	AWG	2 x (24 ... 16)	

Overview



SIRIUS 3UG4615 monitoring relay

Electronic line monitoring relays provide maximum protection for mobile machines and plants or for unstable networks. Network and voltage faults can thus be detected early and rectified before far greater damage ensues.

Depending on the version, the relays monitor phase sequence, phase failure with and without N conductor monitoring, phase asymmetry, undervoltage or overvoltage.

Phase asymmetry is evaluated as the difference between the greatest and the smallest phase voltage relative to the greatest phase voltage. Undervoltage or overvoltage exists when at least one phase voltage deviates by 20% from the set rated system voltage or the directly set limit values are overshoot or undershot. The rms value of the voltage is measured.

With the 3UG4617 or 3UG4618 relay, a wrong direction of rotation can also be corrected automatically.

Benefits

- Can be used without auxiliary voltage in any network from 160 to 630 V AC worldwide thanks to wide voltage range
- Variably adjustable to overshoot, undershoot or range monitoring
- Freely configurable delay times and RESET response
- Width 22.5 mm
- Permanent display of actual value and line fault type on the digital versions
- Automatic correction of the direction of rotation by distinguishing between power system faults and wrong phase sequence
- All versions with removable terminals
- All versions with screw or spring-type terminals

Application

The relays are used above all for mobile equipment, e.g. air conditioning compressors, refrigerating containers, building site compressors and cranes.

Function	Application
Phase sequence	<ul style="list-style-type: none"> • Direction of rotation of the drive
Phase failure	<ul style="list-style-type: none"> • A fuse has tripped • Failure of the control supply voltage • Broken cable
Phase asymmetry	<ul style="list-style-type: none"> • Overheating of the motor due to asymmetrical voltage • Detection of asymmetrically loaded networks
Undervoltage	<ul style="list-style-type: none"> • Increased current on a motor with corresponding overheating • Unintentional resetting of a device • Network collapse, particularly with battery power
Overvoltage	<ul style="list-style-type: none"> • Protection of a plant against destruction due to overvoltage

Technical specifications

3UG4511 monitoring relays

The 3UG4511 phase sequenced relay monitors the phase sequence in a three-phase network. No adjustments are required for operation. The device has an internal power supply and works using the closed-circuit principle. If the phase sequence at the terminals L1-L2-L3 is correct, the output relay picks up after the delay time has elapsed and the LED is lit. If the phase sequence is wrong, the output relay remains in its rest position.

Note:

When one phase fails, connected loads (motor windings, lamps, transformers, coils, etc.) create a feedback voltage at the terminal of the failed phase due to the network coupling. Because the 3UG4511 relays are not resistant to voltage feedback, such a phase failure is not detected. Should this be required, then the 3UG4512 monitoring relay must be used.

Correct phase sequence

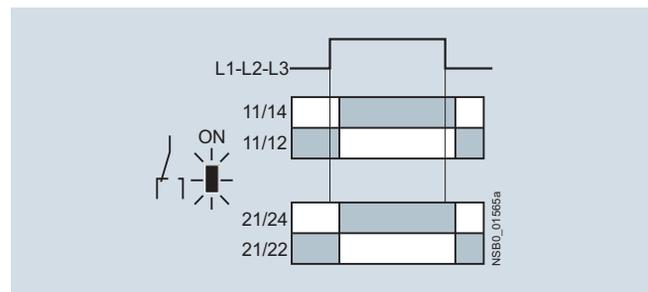

Wrong phase sequence

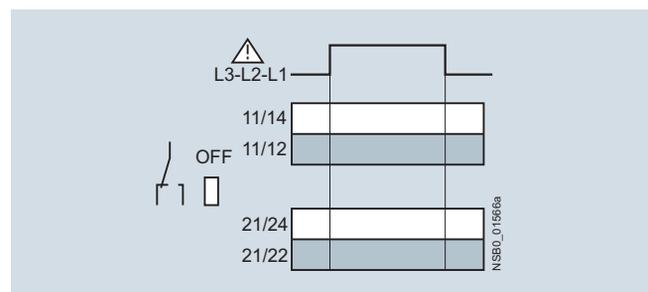

3UG45, 3UG46 Monitoring Relays for Stand-Alone Installation

Line monitoring

3UG4512 monitoring relays

The 3UG4512 line monitoring relay monitors three-phase networks with regard to phase sequence, phase failure and phase unbalance of 10%. Thanks to a special measuring method, a phase failure is reliably detected in spite of the wide voltage range from 160 to 690 V AC and feedback through the load of up to 90%. The device has an internal power supply and works using the closed-circuit principle. No adjustments are required. If the line voltage is switched on, the green LED will light up. If the phase sequence at the terminals L1-L2-L3 is correct, the output relay picks up. If the phase sequence is wrong, the red LED flashes and the output relay remains in its rest position. If a phase fails, the red LED is permanently lit and the output relay drops.

Note:

The red LED is a fault diagnostic indicator and does not show the current relay status. The 3UG4512 monitoring relay is suitable for line frequencies of 50/60 Hz.

Phase failure

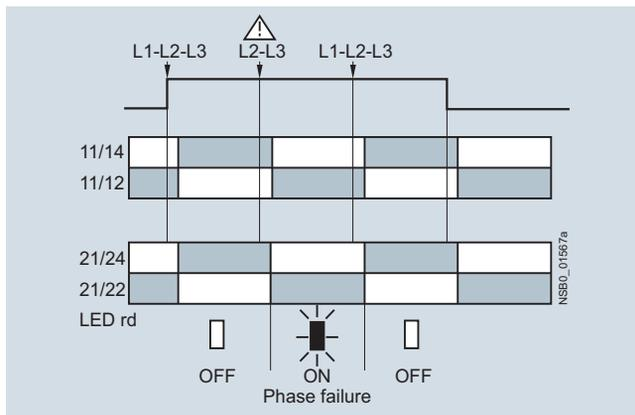

Wrong phase sequence

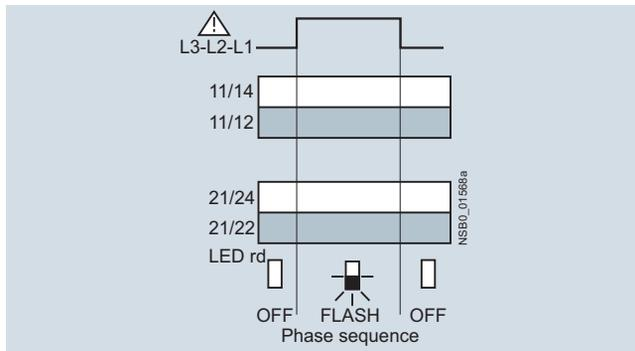

3UG4513 monitoring relays

The 3UG4513 line monitoring relay monitors three-phase networks with regard to phase sequence, phase failure, phase asymmetry and undervoltage of 20%. The device has an internal power supply and works using the closed-circuit principle. The hysteresis is 5%. The integrated response delay time T is adjustable from 0 to 20 s and responds to undervoltage. If the direction is incorrect, the device switches off immediately. Thanks to a special measuring method, a phase failure is reliably detected in spite of the wide voltage range from 160 to 690 V and feedback through the load of up to 80%. If the line voltage is switched on, the green LED will light up. If the phase sequence at the terminals L1-L2-L3 is correct, the output relay picks up. If the phase sequence is wrong, the red LED flashes and the output relay remains in its rest position. If a phase fails, the red LED is permanently lit and the output relay drops.

Note:

The red LED is a fault diagnostic indicator and does not show the current relay status. The 3UG4513 monitoring relay is suitable for line frequencies of 50/60 Hz.

Phase failure and undervoltage

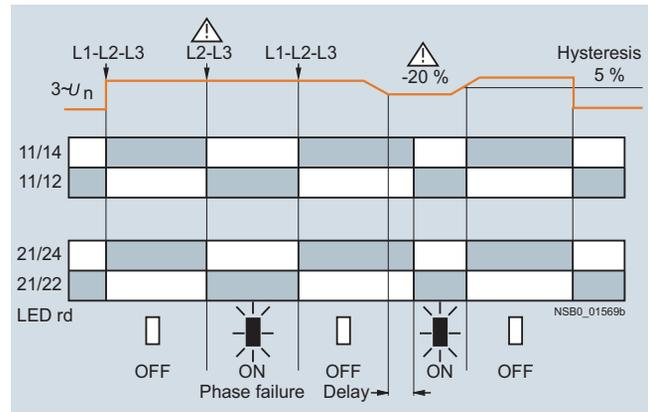

Wrong phase sequence

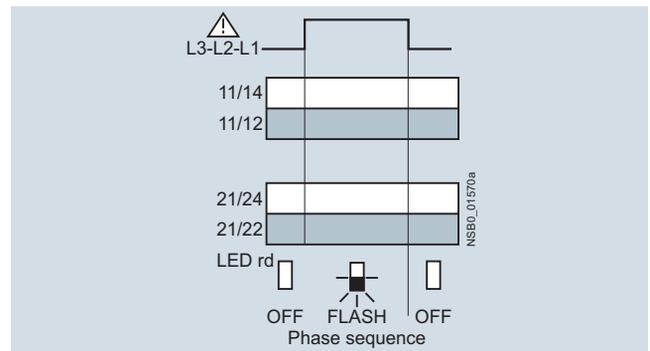

3UG45, 3UG46 Monitoring Relays for Stand-Alone Installation

Line monitoring

3UG4614 monitoring relays

The 3UG4614 line monitoring relay has a wide voltage range input and an internal power supply. The device is equipped with a display and is parameterized using three buttons. The unit monitors three-phase networks with regard to phase asymmetry from 5 to 20%, phase failure, undervoltage and phase sequence. The hysteresis is adjustable from 1 to 20 V. In addition the device has a response delay and ON-delay from 0 to 20 s in each case. The integrated response delay time responds to phase asymmetry and undervoltage. If the direction is incorrect, the device switches off immediately. Thanks to a special measuring method, a phase failure is reliably detected in spite of the wide voltage range from 160 to 690 V and feedback through the load of up to 80%.

The 3UG4614 monitoring relay can be operated on the basis of either the open-circuit or closed-circuit principle and with Manual or Auto RESET.

With the closed-circuit principle selected

Wrong phase sequence

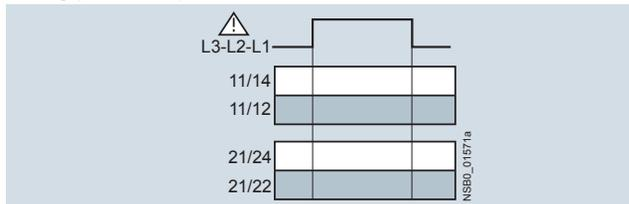

Phase failure

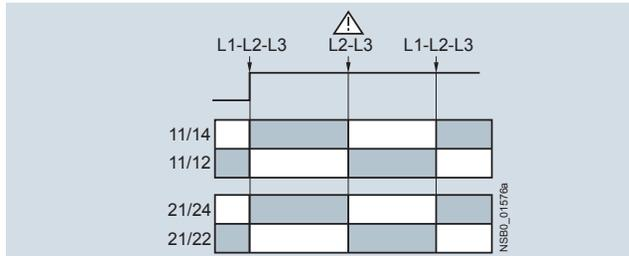

Undervoltage

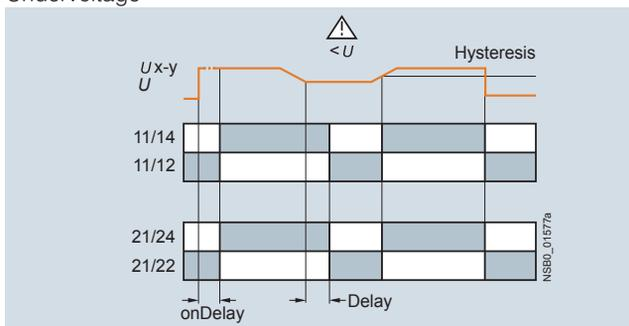

Unbalance

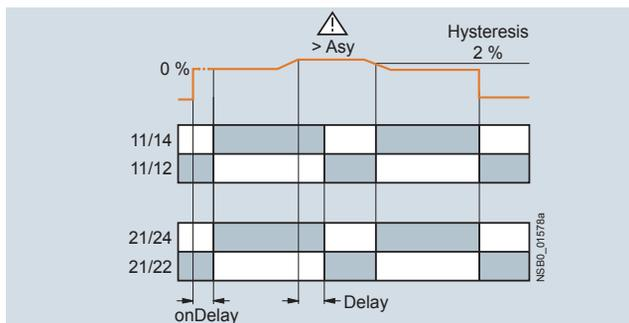

3UG4615/3UG4616 monitoring relays

The 3UG4615/3UG4616 line monitoring relay has a wide voltage range input and an internal power supply. The device is equipped with a display and is parameterized using three buttons. The 3UG4615 device monitors three-phase networks with regard to phase failure, undervoltage, overvoltage and phase sequence. The 3UG4616 monitoring relay monitors the neutral conductor as well. The hysteresis is adjustable from 1 to 20 V. In addition the device has two separately adjustable delay times for overvoltage and undervoltage from 0 to 20 s in each case. If the direction of rotation is incorrect, the device switches off immediately. Thanks to a special measuring method, a phase failure is reliably detected in spite of the wide voltage range from 160 to 690 V and feedback through the load of up to 80%.

The 3UG4615/3UG4616 monitoring relay can be operated on the basis of either the open-circuit or closed-circuit principle and with Manual or Auto RESET.

With the closed-circuit principle selected

Wrong phase sequence

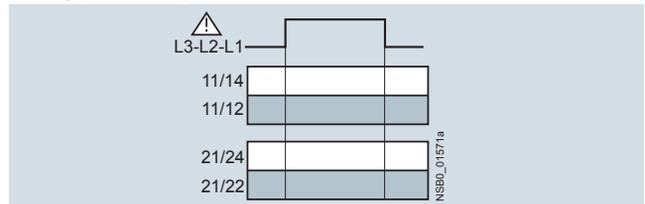

Phase failure

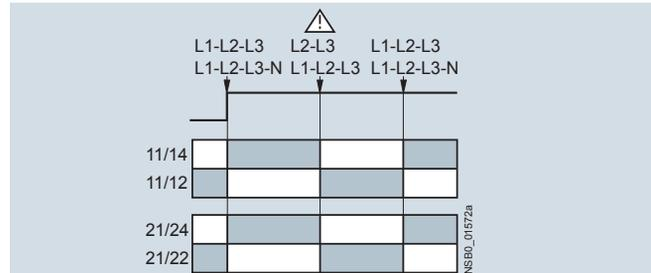

Undervoltage

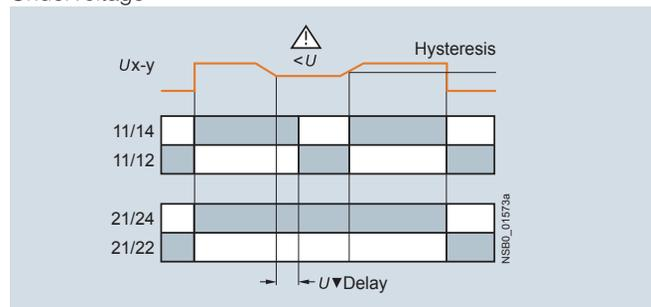

Overvoltage

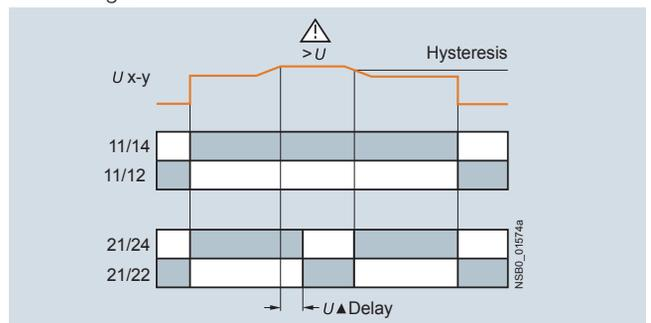

3UG45, 3UG46 Monitoring Relays for Stand-Alone Installation

Line monitoring

3UG4617/3UG4618 monitoring relays

The 3UG4617/3UG4618 line monitoring relay has an internal power supply and can automatically correct a wrong direction of rotation. Thanks to a special measuring method, a phase failure is reliably detected in spite of the wide voltage range from 160 to 690 V AC and feedback through the load of up to 80%. The device is equipped with a display and is parameterized using three buttons. The 3UG4617 line monitoring relay unit monitors three-phase networks with regard to phase sequence, phase failure, phase unbalance, undervoltage and overvoltage. The 3UG4618 monitoring relay monitors the neutral conductor as well. The hysteresis is adjustable from 1 to 20 V. In addition the device has delay times from 0 to 20 s in each case for overvoltage, undervoltage, phase failure and phase unbalance. The 3UG4617/3UG4618 monitoring relay can be operated on the basis of either the open-circuit or closed-circuit principle and with Manual or Auto RESET.

The one changeover contact is used for warning or disconnection in the event of power system faults (voltage, asymmetry), the other responds only to a wrong phase sequence. In conjunction with a contactor reversing assembly it is thus possible to change the direction automatically.

With the closed-circuit principle selected

Phase failure

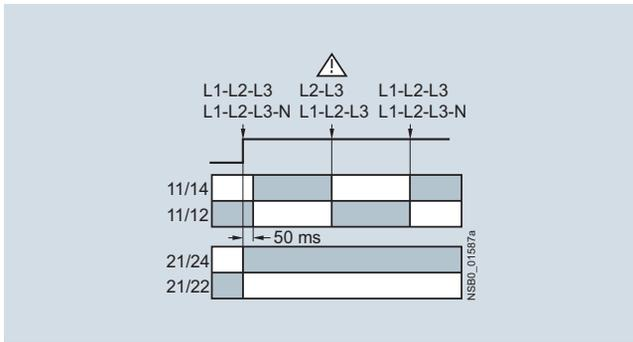

Undervoltage

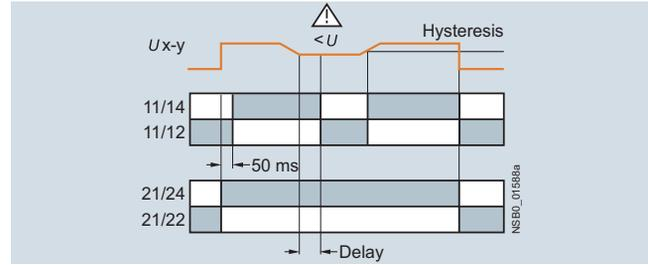

Overvoltage

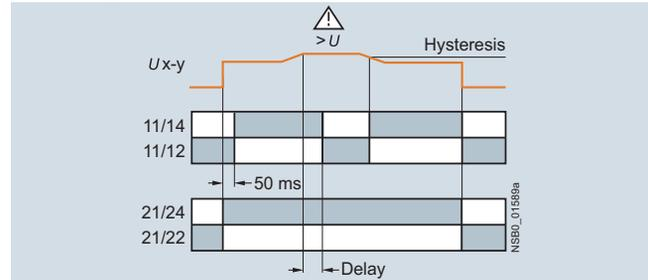

Unbalance

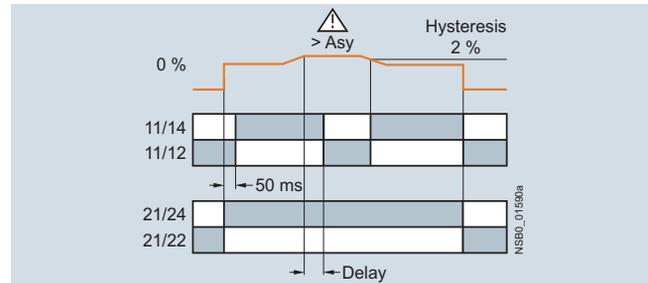

Type	3UG4511 ... 3UG4513, 3UG4614 ... 3UG4618	
General data		
Rated insulation voltage U_i	V	690
Pollution degree 3 Overvoltage category III acc. to VDE 0110		
Rated impulse withstand voltage U_{imp}	kV	6
Control circuit		
Load capacity of the output relay		
• Thermal current I_{th}	A	5
Rated operational current I_e at		
• AC-15/24 ... 400 V	A	3
• DC-13/24 V	A	1
• DC-13/125 V	A	0.2
• DC-13/250 V	A	0.1
Minimum contact load at 17 V DC	mA	5
Electrical endurance AC-15	Million operating cycles	0.1
Mechanical endurance	Million operating cycles	10

Selection and ordering data

PU (UNIT, SET, M) = 1
 PKG* = 1 UNIT



Adjustable hysteresis	Under-voltage detection	Over-voltage detection	Stabilization time adjustable stDEL	Tripping delay time adjustable Del	Version of auxiliary contacts	Measurable line voltage ¹⁾	SD	Screw terminals	SD	Spring-type terminals	
			s	s	CO contact	V	d	Article No.	Price per PU	Article No.	Price per PU
Monitoring of phase sequence											
Auto RESET											
--	--	--	--	--	1	160 ... 260 AC	2	3UG4511-1AN20	2	3UG4511-2AN20	
					2		2	3UG4511-1BN20	2	3UG4511-2BN20	
					1	320 ... 500 AC	2	3UG4511-1AP20	2	3UG4511-2AP20	
					2		2	3UG4511-1BP20	2	3UG4511-2BP20	
					1	420 ... 690 AC	2	3UG4511-1AQ20	5	3UG4511-2AQ20	
					2		2	3UG4511-1BQ20	5	3UG4511-2BQ20	
Monitoring of phase sequence, phase failure and phase unbalance											
Auto RESET, closed-circuit principle, unbalance threshold permanently 10%											
--	--	--	--	--	1	160 ... 690 AC	2	3UG4512-1AR20	2	3UG4512-2AR20	
					2		2	3UG4512-1BR20	2	3UG4512-2BR20	
Monitoring of phase sequence, phase failure, unbalance and undervoltage											
Analogically adjustable, Auto RESET, closed-circuit principle, asymmetry and undervoltage threshold permanently 20%											
5% of set value	✓	--	--	0.1 ... 20	2	160 ... 690 AC	2	3UG4513-1BR20	2	3UG4513-2BR20	
Digitally adjustable, Auto RESET or Manual RESET, open-circuit or closed-circuit principle, asymmetry threshold 0 or 5 ... 20%											
adjustable	✓	--	0.1 ... 20	0.1 ... 20	2	160 ... 690 AC	2	3UG4614-1BR20	2	3UG4614-2BR20	
1 ... 20 V											
Monitoring of phase sequence, phase failure, overvoltage and undervoltage											
Digitally adjustable, Auto RESET or Manual RESET, open-circuit or closed-circuit principle											
adjustable	✓	✓	--	0.1 ... 20 ²⁾	2 ²⁾	160 ... 690 AC	2	3UG4615-1CR20	2	3UG4615-2CR20	
1 ... 20 V											
Monitoring of phase sequence, phase and N conductor failure, overvoltage and undervoltage											
Digitally adjustable, Auto RESET or Manual RESET, open-circuit or closed-circuit principle											
adjustable	✓	✓	--	0.1 ... 20 ²⁾	2 ²⁾	90 ... 400 AC against N	2	3UG4616-1CR20	2	3UG4616-2CR20	
1 ... 20 V											
Automatic correction of the direction of rotation in case of wrong phase sequence, phase failure, unbalance, overvoltage and undervoltage											
Digitally adjustable, Auto RESET or Manual RESET, open-circuit or closed-circuit principle, asymmetry threshold 0 or 5 ... 20%											
adjustable	✓	✓	--	0.1 ... 20	2 ³⁾	160 ... 690 AC	2	3UG4617-1CR20	2	3UG4617-2CR20	
1 ... 20 V											
Automatic correction of the direction of rotation in case of wrong phase sequence, phase and N conductor failure, phase unbalance, overvoltage and undervoltage											
Digitally adjustable, Auto RESET or Manual RESET, open-circuit or closed-circuit principle, asymmetry threshold 0 or 5 ... 20%											
adjustable	✓	✓	--	0.1 ... 20	2 ³⁾	90 ... 400 AC against N	2	3UG4618-1CR20	2	3UG4618-2CR20	
1 ... 20 V											

✓ Function available
 -- Function not available

¹⁾ Absolute limit values.

²⁾ 1 CO contact each and one tripping delay time each for U_{min} and U_{max} .

³⁾ 1 CO contact each for power system fault and phase sequence correction.

For accessories, see page 11/85

Overview



SIRIUS 3UG4631 monitoring relay

The relays monitor single-phase AC voltages (rms value) and DC voltages against the set threshold value for overshoot and undershoot. The devices differ with regard to their power supply (internal or external).

Benefits

- Versions with wide voltage supply range
- Variably adjustable to overshoot, undershoot or range monitoring
- Freely configurable delay times and RESET response
- Width 22.5 mm
- Display of ACTUAL value and status messages
- All versions with removable terminals
- All versions with screw or spring-type terminals

Application

- Protection of a plant against destruction due to overvoltage
- Switch-on of a plant at a defined voltage and higher
- Protection from undervoltage due to overloaded control supply voltages, particularly with battery power
- Threshold switch for analog signals from 0.1 to 10 V

Technical specifications

3UG4631/3UG4632 monitoring relays

The 3UG4631/3UG4632 voltage monitoring relay is supplied with an auxiliary voltage of 24 V AC/DC or 24 to 240 V AC/DC and performs overshoot, undershoot or range monitoring of the voltage depending on parameterization. The device is equipped with a display and is parameterized using three buttons.

The measuring range extends from 0.1 to 60 V or 10 to 600 V AC/DC. The threshold values for overshoot or undershoot can be freely configured within this range. If one of these threshold values is reached, the output relay responds according to the set principle of operation as soon as the delay time has elapsed. This delay time U_{Del} can be set from 0.1 to 20 s. The hysteresis can be set from 0.1 to 30 V or 0.1 to 300 V. The device can be operated on the basis of either the open-circuit or closed-circuit principle and with Manual or Auto RESET. One output changeover contact is available as signaling contact.

With the closed-circuit principle selected

Overvoltage

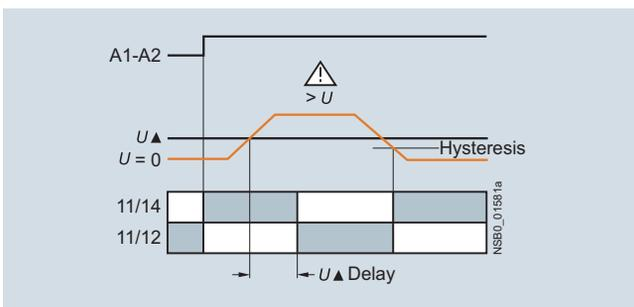

Undervoltage

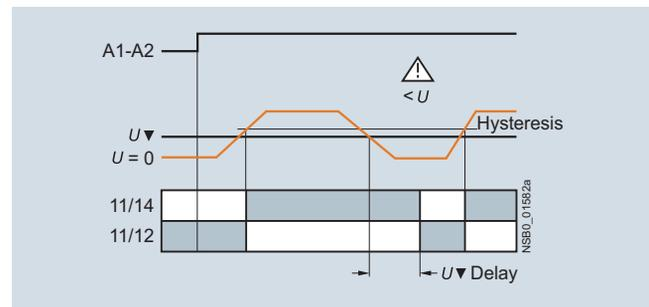

Range monitoring

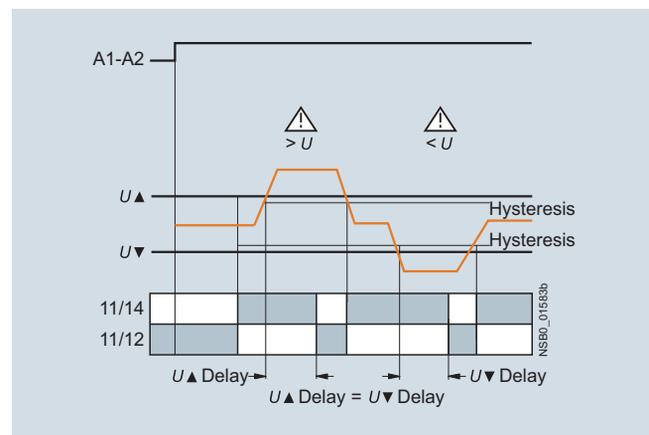

3UG4633 monitoring relay

The 3UG4633 voltage monitoring relay has an internal power supply and performs overshoot, undershoot or range monitoring of the voltage depending on parameterization. The device is equipped with a display and is parameterized using three buttons.

The operating and measuring range extends from 17 to 275 V AC/DC. The threshold values for overshoot or undershoot can be freely configured within this range. If one of these threshold values is reached, the output relay responds according to the set principle of operation as soon as the tripping delay time has elapsed. This delay time U_{Del} can also be adjusted, just like the ON-delay time on_{Del} , from 0.1 to 20 s.

The hysteresis is adjustable from 0.1 to 150 V. The device can be operated on the basis of either the open-circuit or closed-circuit principle and with Manual or Auto RESET. One output change-over contact is available as signaling contact.

With the closed-circuit principle selected

Overvoltage

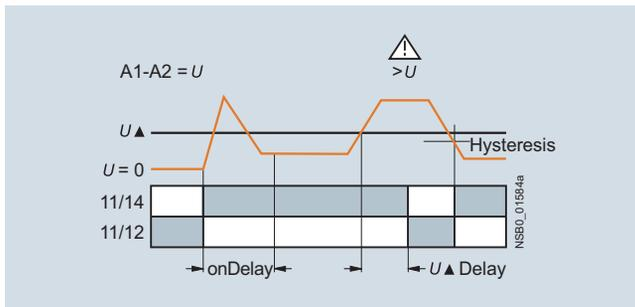

Undervoltage

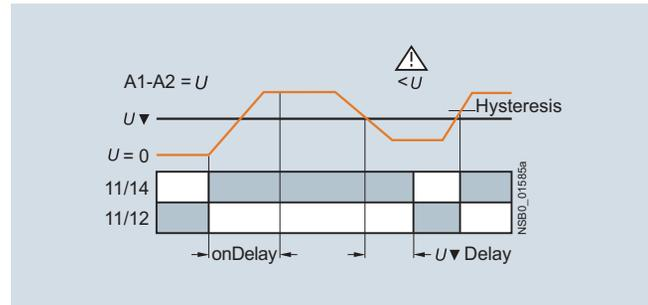

Range monitoring

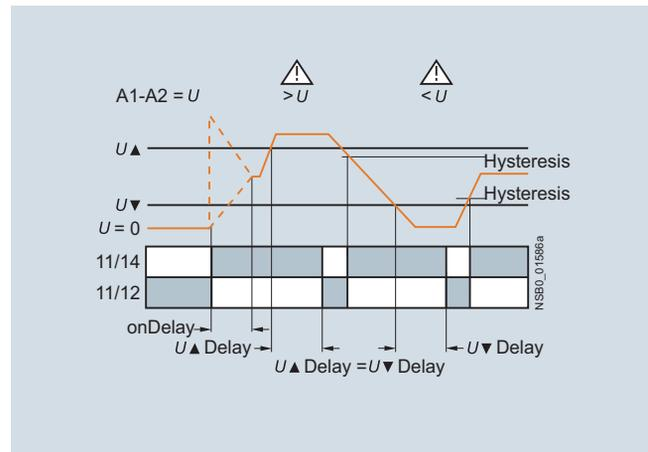

Type		3UG4631	3UG4632	3UG4633
General data				
Rated insulation voltage U_i	V	690		
Pollution degree 3 Overvoltage category III acc. to VDE 0110				
Rated impulse withstand voltage U_{imp}	kV	6		
Measuring circuit				
Permissible measuring range single-phase AC/DC voltage	V	0.1 ... 68	10 ... 650	17 ... 275
Measuring frequency	Hz	40 ... 500		
Setting range single-phase voltage	V	0.1 ... 60	10 ... 600	17 ... 275
Control circuit				
Load capacity of the output relay				
• Thermal current I_{th}	A	5		
Rated operational current I_e at				
• AC-15/24 ... 400 V	A	3		
• DC-13/24 V	A	1		
• DC-13/125 V	A	0.2		
• DC-13/250 V	A	0.1		
Minimum contact load at 17 V DC	mA	5		

3UG45, 3UG46 Monitoring Relays for Stand-Alone Installation

Voltage monitoring

Selection and ordering data

- Digitally adjustable, with illuminated LCD
- Auto or Manual RESET
- Open- or closed-circuit principle
- 1 CO contact

PU (UNIT, SET, M) = 1
 PKG* = 1 UNIT



3UG4631-1AA30



3UG4633-2AL30

Measuring range	Adjustable hysteresis	Rated control supply voltage U_s	SD	Screw terminals 	SD	Spring-type terminals 	
V	V	V	d	Article No.	Price per PU	Article No.	Price per PU
Internal power supply without auxiliary voltage, separately adjustable ON-delay and tripping delay 0.1 ... 20 s							
17 ... 275 AC/DC	0.1 ... 150	17 ... 275 AC/DC ¹⁾	2	3UG4633-1AL30	2	3UG4633-2AL30	
Externally supplied with auxiliary voltage, tripping delay adjustable 0.1 ... 20 s							
0.1 ... 60 AC/DC	0.1 ... 30	24 AC/DC	2	3UG4631-1AA30	2	3UG4631-2AA30	
10 ... 600 AC/DC	0.1 ... 300		2	3UG4632-1AA30	2	3UG4632-2AA30	
0.1 ... 60 AC/DC	0.1 ... 30	24 ... 240 AC/DC	2	3UG4631-1AW30	2	3UG4631-2AW30	
10 ... 600 AC/DC	0.1 ... 300		2	3UG4632-1AW30	2	3UG4632-2AW30	

¹⁾ Absolute limit values.

For accessories, see page 11/85

Overview



SIRIUS 3UG4622 monitoring relay

The relays monitor single-phase AC currents (rms value) and DC currents against the set threshold value for overshoot and undershoot. They differ with regard to their measuring ranges and control supply voltage types.

Benefits

- Versions with wide voltage supply range
- Variably adjustable to overshoot, undershoot or range monitoring
- Freely configurable delay times and RESET response
- Width 22.5 mm
- Display of ACTUAL value and status messages
- All versions with removable terminals
- All versions with screw or spring-type terminals

Application

- Overcurrent and undercurrent monitoring
- Monitoring the functionality of electrical loads
- Open-circuit monitoring
- Threshold switch for analog signals from 4 to 20 mA

Technical specifications

3UG4621/3UG4622 monitoring relays

The 3UG4621 or 3UG4622 current monitoring relay is supplied with an auxiliary voltage of 24 V AC/DC or 24 to 240 V AC/DC and performs overshoot, undershoot or range monitoring of the current depending on parameterization. The device is equipped with a display and is parameterized using three buttons.

The measuring range extends from 3 to 500 mA or 0.05 to 10 A. The rms value of the current is measured. The threshold values for overshoot or undershoot can be freely configured within this range. If one of these threshold values is reached, the output relay responds according to the set principle of operation as soon as the tripping delay time I_{Del} has elapsed. This time and the ON-delay time on_{Del} are adjustable from 0.1 to 20 s.

The hysteresis is adjustable from 0.1 to 250 mA or 0.01 to 5 A. The device can be operated with Manual or Auto RESET and on the basis of either the open-circuit or closed-circuit principle. You can decide here whether the output relay is to respond when the supply voltage $U_s = ON$ is applied, or not until the lower measuring range limit of the measuring current ($I > 3 \text{ mA}/50 \text{ mA}$) is reached. One output changeover contact is available as signaling contact.

With the closed-circuit principle selected upon application of the control supply voltage

Current overshoot

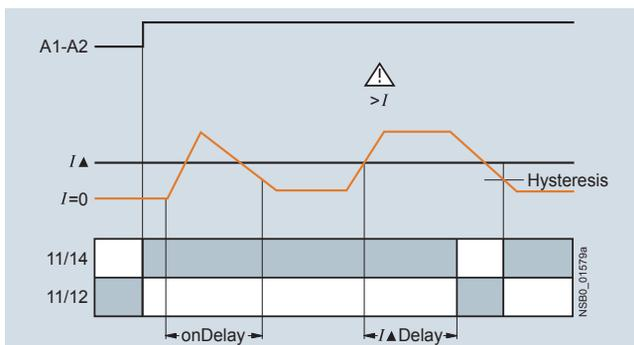

Current undershoot

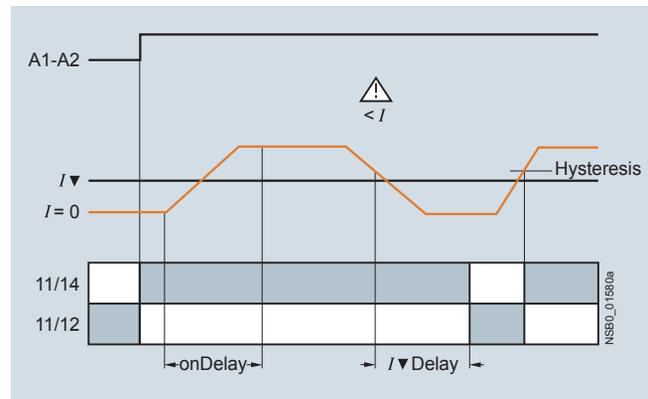

Range monitoring

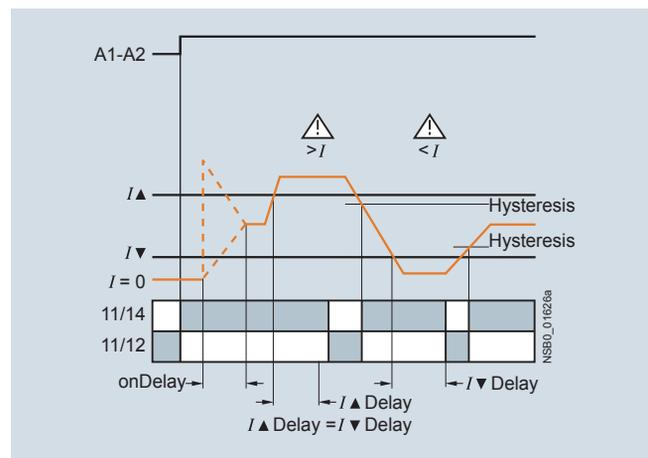

3UG45, 3UG46 Monitoring Relays for Stand-Alone Installation

Current monitoring

Type		3UG4621-AA	3UG4621-AW	3UG4622-AA	3UG4622-AW
General data					
Rated insulation voltage U_i	V	690			
Pollution degree 3; overvoltage category III according to VDE 0110					
Rated impulse withstand voltage U_{imp}	kV	6			
Measuring circuit					
Measuring range for single-phase AC/DC current	A	0.003 ... 0.6		0.05 ... 15	
Measuring frequency	Hz	40 ... 500			
Setting range for single-phase current	A	0.003 ... 0.5		0.05 ... 10	
Load supply voltage	V	24	Max. 300 ¹⁾ Max. 500 ²⁾	24	Max. 300 ¹⁾ Max. 500 ²⁾
Control circuit					
Load capacity of the output relay					
• Thermal current I_{th}	A	5			
Rated operational current I_e at					
• AC-15/24 ... 400 V	A	3			
• DC-13/24 V	A	1			
• DC-13/125 V	A	0.2			
• DC-13/250 V	A	0.1			
Minimum contact load at 17 V DC	mA	5			

1) With protective separation.

2) With simple separation.

Selection and ordering data

- Digitally adjustable, with illuminated LCD
- Auto or Manual RESET
- Open- or closed-circuit principle
- 1 CO contact

PU (UNIT, SET, M) = 1
PKG* = 1 UNIT



3UG4621-1AA30



3UG4622-2AW30

Measuring range	Adjustable hysteresis	Rated control supply voltage U_s	SD	Screw terminals	SD	Spring-type terminals			
		V	d	Article No.	Price per PU	d	Article No.	Price per PU	
Monitoring of undercurrent and overcurrent, start up delay and tripping delay times can be adjusted separately 0.1 ... 20 s									
3 ... 500 mA AC/DC	0.1 ... 250 mA	24 AC/DC ¹⁾	2	3UG4621-1AA30	2	3UG4621-2AA30			
0.05 ... 10 A AC/DC	0.01 ... 5 A		2	3UG4622-1AA30	2	3UG4622-2AA30			
3 ... 500 mA AC/DC	0.1 ... 250 mA	24 ... 240 AC/DC ²⁾	2	3UG4621-1AW30	2	3UG4621-2AW30			
0.05 ... 10 A AC/DC	0.01 ... 5 A		2	3UG4622-1AW30	2	3UG4622-2AW30			

1) No electrical separation. Load supply voltage 24 V.

2) Electrical separation between control circuit and measuring circuit. Load supply voltage for protective separation max. 300 V, for simple separation max. 500 V.

For accessories, see page 11/85

With AC currents $I > 10$ A it is possible to use 4NC current transformers as an accessory.

Overview



SIRIUS 3UG4641 monitoring relay

The 3UG4641 power factor and active current monitoring device enables the load monitoring of motors.

Whereas power factor (p.f.) monitoring is used above all for monitoring no-load operation, the active current monitoring option can be used to observe and evaluate the load factor over the entire torque range.

Technical specifications

3UG4641 monitoring relay

The 3UG4641 monitoring relay is self-powered and serves the single-phase monitoring of the power factor or performs overshoot, undershoot or range monitoring of the active current depending on how it is parameterized. The load to be monitored is connected upstream of the IN terminal. The load current flows through the terminals IN and Ly/N. The setting range for the power factor is 0.1 to 0.99 and for the active current I_{res} it is 0.2 to 10 A. If the control supply voltage is switched on and no load current flows, the display will show $I < 0.2$ A and a symbol for overrange, underrange or range monitoring. If the motor is now switched on and the current exceeds 0.2 A, the set ON-delay time begins. During this time, if the set limit values are undershot or exceeded, this does not lead to a relay reaction of the changeover contact. If the operational flowing active current and/or the power factor value falls below or exceeds the respective set threshold value, the spike delay begins. When this time has expired, the relay changes its switch position. The relevant measured variables for overshooting and undershooting in the display flash. If monitoring for active current undershoot is switched off ($I_{res} \nabla = \text{OFF}$), and if the load current undershoots the lower measuring range threshold (0.2 A), the CO contacts remain unchanged. If a threshold value is set for the monitoring of active current undershooting, then undershooting of the measuring range threshold (0.2 A) will result in a response of the CO contacts.

The relay operates either according to the open-circuit or closed-circuit principle. If the device is set to Auto RESET (Memory = No), depending on the set principle of operation, the switching relay returns to its initial state and the flashing ends when the hysteresis threshold is reached.

If Manual RESET is selected in the menu (Memory = Yes), the switching relay remains in its current switching state and the current measured value and the symbol for undershooting and overshooting continues to flash, even when the measured variable reaches a permissible value again. This stored fault status can be reset by simultaneously pressing the UP▲ and DOWN▼ keys for 2 seconds, or by switching the supply voltage off and back on again.

Benefits

- Can be used worldwide thanks to wide voltage range from 90 to 690 V (absolute limit values)
- Monitoring of even small single-phase motors with a no-load supply current below 0.5 A
- Simple determination of threshold values by the direct collection of measured variables on motor loading
- Range monitoring and active current measurement enable detection of cable breaks between control cabinets and motors, as well as phase failures
- Power factor (p.f.) or I_{res} (active current) can be selected as the measurement principle
- Width 22.5 mm
- All versions with removable terminals

Application

- No-load monitoring and load shedding, such as in the event of a V-belt tear
- Underload monitoring in the low-end performance range, e.g. in the event of pump no-load operation
- Monitoring of overload, e.g. due to a dirty filter system
- Simple power factor monitoring in power systems for control of compensation equipment
- Broken cable between control cabinet and motor

With the closed-circuit principle selected

Response in the event of undershooting the measuring range limit

- With activated monitoring of $I_{res} \nabla$

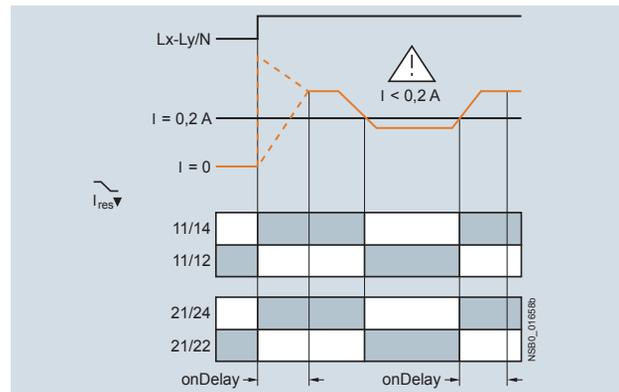

- With deactivated monitoring of active current undershooting

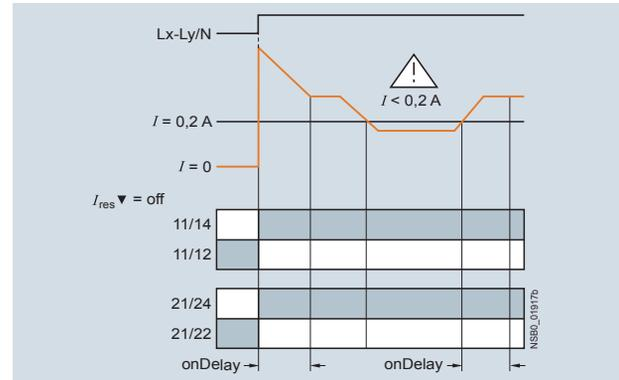

Overshooting of active current

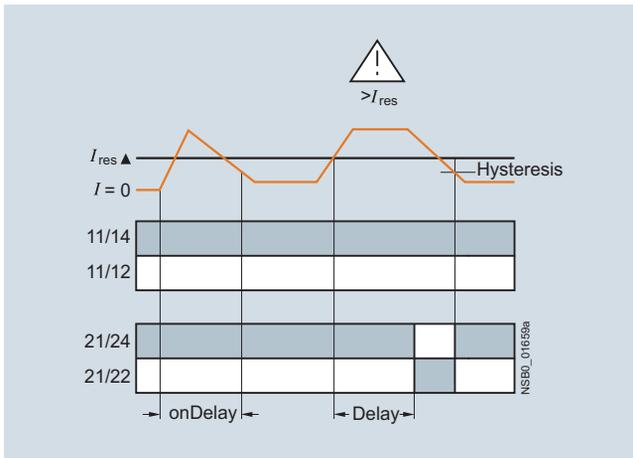

Overshooting of power factor

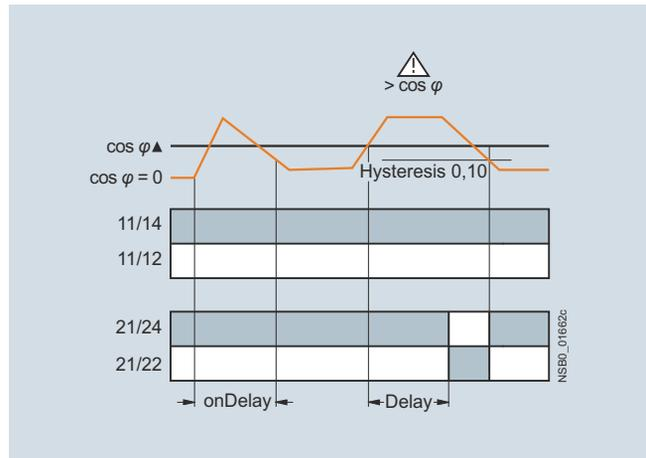

Undershooting of active current

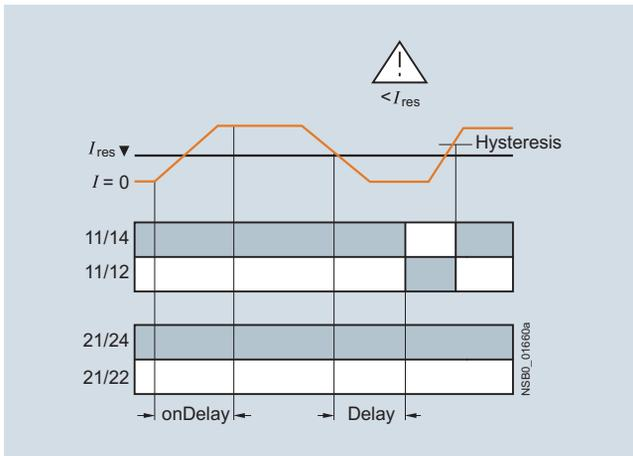

Undershooting of power factor

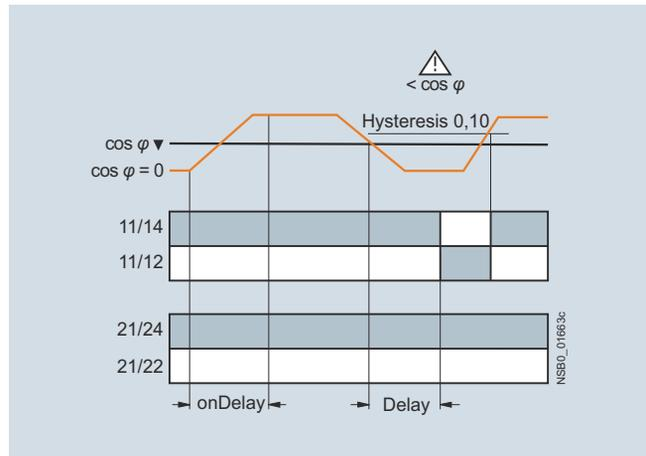

Range monitoring of active current

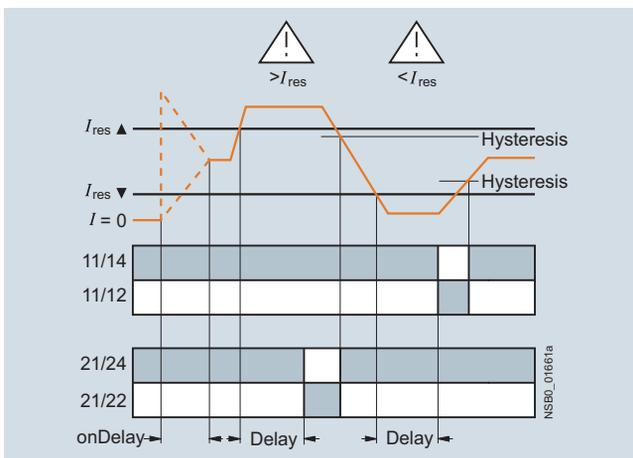

Range monitoring of power factor

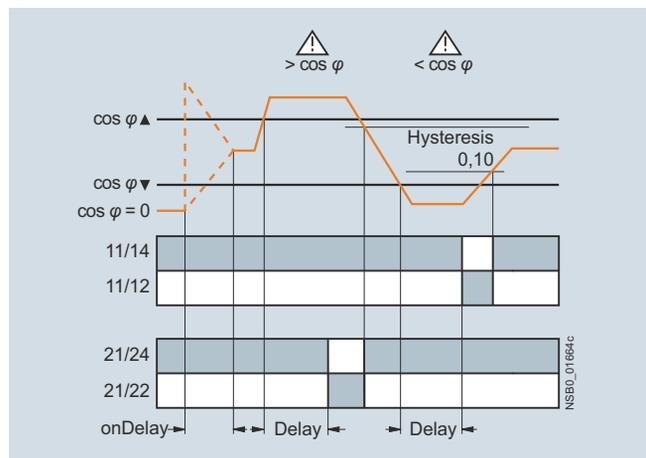

Type	3UG4641	
General data		
Rated insulation voltage U_i Pollution degree 3 Overvoltage category III acc. to VDE 0110	V	690
Rated impulse withstand voltage U_{imp}	kV	6
Control circuit		
Number of CO contacts for auxiliary contacts		2
Load capacity of the output relay		
• Thermal current I_{th}	A	5
Rated operational current I_e at		
• AC-15/24 ... 400 V	A	3
• DC-13/24 V	A	1
• DC-13/125 V	A	0.2
• DC-13/250 V	A	0.1
Minimum contact load at 17 V DC	mA	5

Selection and ordering data

- For monitoring the power factor and the active current I_{res} (p.f. $\times I$)
- Suitable for single- and three-phase currents
- Digitally adjustable, with illuminated LCD
- Overshoot, undershoot or range monitoring adjustable
- Upper and lower threshold value can be adjusted separately
- Permanent display of actual value and tripping state
- 1 changeover contact each for undershoot/overshoot

PU (UNIT, SET, M) = 1
PKG* = 1 UNIT

Measuring range		Adjustable hysteresis		ON-delay time adjustable onDel	Tripping delay time adjustable	Rated control supply voltage U_s ¹⁾	SD	Screw terminals	SD	Spring-type terminals		
For power factor	For active current I_{res}	For power factor	For active current I_{res}		$I \blacktriangle \text{Del} / I \blacktriangledown \text{Del} / \varphi \blacktriangle \text{Del} / \varphi \blacktriangledown \text{Del}$	50/60 Hz AC						
P.f.	A	P.f.	A	s	s	V	d	Article No.	Price per PU	d	Article No.	Price per PU
0.10 ... 0.99	0.2 ... 10.0	0.1	0.1 ... 2.0	0 ... 99	0.1 ... 20.0	90 ... 690	2	3UG4641-1CS20		2	3UG4641-2CS20	

¹⁾ Absolute limit values.

For accessories, see page 11/85

With AC active currents $I_{res} > 10$ A it is possible to use 4NC current transformers as an accessory, see Catalog LV 10.

Overview



SIRIUS 3UG4625 monitoring relay

The 3UG4625 residual-current monitoring relays are used in conjunction with the 3UL23 residual-current transformers for monitoring plants in which higher residual currents are increasingly expected due to ambient conditions. Monitoring encompasses pure AC residual currents or AC residual currents with a pulsating DC fault current component (transformer type A in accordance with DIN VDE 0100-530/IEC TR 60755).

Technical specifications

3UG4625 monitoring relays

The main conductor, and any neutral conductor to which a load is connected, are routed through the opening of the annular ring core of a residual-current transformer. A secondary winding is placed around this annular strip-wound core to which the monitoring relay is connected.

If operation of a plant is fault-free, the sum of the inflowing and outward currents equals zero. No current is then induced in the secondary winding of the residual-current transformer.

However, if an insulation fault occurs downstream of the residual current operated circuit breaker, the sum of the inflowing currents is greater than that of the outward currents. The differential current – i.e. the residual current – induces a secondary current in the secondary winding of the transformer. This current is evaluated in the monitoring relay and is used on the one hand to display the actual residual current and on the other, to switch the relay if the set warning or tripping threshold is overshoot.

If the measured residual current exceeds the set warning value, the associated changeover contact instantly changes the switching state and an indication appears on the display.

If the measured residual current exceeds the set tripping value, the set delay time begins and the associated relay symbol flashes. On expiry of this time, the associated changeover contact changes the switching state.

ON-delay time for motor start

To be able to start a drive when a residual current is detected, the output relays switch to the OK state for an adjustable ON-delay time depending on the selected open-circuit principle or closed-circuit principle.

The changeover contacts do not react if the set threshold values are overshoot during this period.

Benefits

- Worldwide use thanks to wide voltage range from 24 to 240 V AC/DC
- High measuring accuracy of $\pm 7.5\%$
- Permanent self-monitoring
- Variable threshold values for warning and disconnection
- Freely configurable delay times and RESET response
- Permanent display of the actual value and fault diagnostics via the display
- High level of flexibility and space saving through installation of the transformer inside or outside the control cabinet
- Width 22.5 mm
- All versions with removable terminals
- All versions with screw or spring-type terminals

Application

Monitoring of plants in which residual currents can occur, e.g. due to dust deposits or moisture, porous cables and leads, or capacitive residual currents.

With the closed-circuit principle selected

Residual current monitoring with Auto RESET (Memory = no)

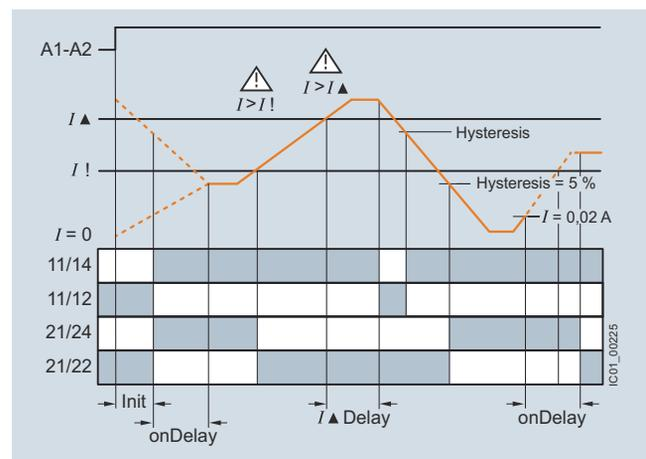

If the device is set to Auto RESET, the relay switches back to the OK state for the tripping value once the value falls below the set hysteresis threshold and the display stops flashing.

The associated relay changes its switching state if the value falls below the fixed hysteresis value of 5% of the set warning value.

Any overshoots are therefore not stored.

3UG45, 3UG46 Monitoring Relays for Stand-Alone Installation

Residual-current monitoring relays

Residual current monitoring with Manual RESET (Memory = yes)

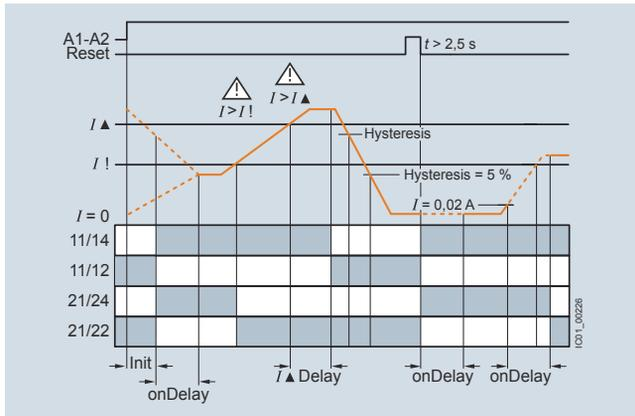

If Manual RESET is selected in the menu, the output relays remain in their current switching state and the current measured value and the symbol for overshooting continues to flash, even when the measured residual current returns to a permissible value. This stored fault status can be reset by simultaneously pressing the UP▲ and DOWN▼ keys for > 2 seconds, or by switching the supply voltage off and back on again.

Note:

Do not ground the neutral conductor downstream of the residual-current transformer as otherwise residual current monitoring functions can no longer be ensured.

Type	3UG4625-1CW30, 3UG4625-2CW30	
General data		
Insulation voltage for overvoltage category III to IEC 60664 for pollution degree 3, rated value	V	300
Impulse withstand voltage, rated value U_{imp}	kV	4
Control circuit		
Number of CO contacts for auxiliary contacts		2
Thermal current of the non-solid-state contact blocks, maximum	A	5
Current carrying capacity of the output relay		
• At AC-15 at 250 V at 50/60 Hz	A	3
• At DC-13		
- At 24 V	A	1
- At 125 V	A	0.2
- At 250 V	A	0.1
Operational current at 17 V, minimum	mA	5

Selection and ordering data

- For monitoring residual currents from 0.03 to 40 A, from 16 to 400 Hz
- For 3UL23 residual-current transformers with feed-through opening from 35 to 210 mm
- Permanent self-monitoring
- Certified in accordance with IEC 60947, functionality corresponds to IEC 62020
- Digitally adjustable, with illuminated LCD

- Permanent display of actual value and tripping state
- Separately adjustable limit value and warning threshold
- 1 changeover contact each for warning threshold and tripping threshold

PU (UNIT, SET, M) = 1
PS* = 1 unit



3UG4625-1CW30



3UG4625-2CW30

Measurable current	Adjustable response value current	Switching hysteresis	Adjustable ON-delay time	Control supply voltage			SD	Screw terminals		SD	Spring-type terminals	
				For AC at 50 Hz rated value	For AC at 60 Hz rated value	At DC rated value		Article No.	Price per PU		Article No.	Price per PU
A	A	%	s	V	V	V	d			d		
0.01 ... 43	0.03 ... 40	0 ... 50	0 ... 20	24 ... 240	24 ... 240	24 ... 240	2	3UG4625-1CW30		2	3UG4625-2CW30	

For accessories, see page 11/85

For 3UL23 residual-current transformers, see page 11/71.

Overview



SIRIUS 3UL23 residual-current transformer

The 3UL23 residual-current transformers detect residual currents in machines and plants. They are suitable for pure AC residual currents or AC residual currents with a pulsating DC fault current component (transformer type A in accordance with DIN VDE 0100-530/IEC TR 60755).

Together with the 3UG4625, 3UG4825 residual-current monitoring relays for IO-Link or the SIMOCODE 3UF motor management and control device they enable residual-current and ground-fault monitoring.

The 3UL2302-1A and 3UL2303-1A residual-current transformers with a feed-through opening from 35 to 55 mm can be mounted in conjunction with the 3UL2900 accessories on a TH 35 standard mounting rail according to IEC 60715.

Selection and ordering data

Diameter of the bushing opening	Connectable cross-section of the connecting terminal	SD	Screw terminals	PU (UNIT, SET, M)	PS*
mm	mm ²	d	Article No.	Price per PU	
Residual-current transformers (essential accessories for 3UG4625, 3UG4825)					
35	2.5	2	3UL2302-1A	1	1 unit
55	2.5	2	3UL2303-1A	1	1 unit
80	2.5	2	3UL2304-1A	1	1 unit
110	2.5	2	3UL2305-1A	1	1 unit
140	2.5	2	3UL2306-1A	1	1 unit
210	4	2	3UL2307-1A	1	1 unit

Accessories

Version	SD	Article No.	Price per PU	PU (UNIT, SET, M)	PS*
	d				
 Adapters For mounting onto standard rail for 3UL23 to diameter 55 mm	2	3UL2900		1	2 units

3UL2900

Overview

SIRIUS 3UG458. insulation monitor

Insulation monitoring relays are used for monitoring the insulation resistance between ungrounded single or three-phase AC supplies and a protective conductor.

Ungrounded, i.e. isolated networks (IT networks) are always used where high demands are placed on the reliability of the power supply, e.g. emergency lighting systems. IT systems are supplied via an isolating transformer or by power supply sources such as batteries or a generator. While an initial insulation fault between a phase conductor and the ground effectively grounds the conductor, as a result no circuit has been closed, so it is possible to continue work in safety (single-fault safety). However, the fault must be rectified as quickly as possible before a second insulation fault occurs (e.g. according to DIN VDE 0100-410). For this purpose insulation monitoring relays are used, which constantly measure the resistance to ground of the phase conductor and the neutral conductor, reporting a fault immediately if insulation resistance falls below the set value so that either a controlled shutdown can be performed or the fault can be rectified without interrupting the power supply.

Two device series

- 3UG4581 insulation monitoring relays for ungrounded AC networks
- 3UG4582 and 3UG4583 insulation monitoring relays for ungrounded DC and AC networks

Benefits

- Devices for AC and DC systems
- All devices have a wide control supply voltage range
- Direct connection to networks with mains voltages of up to 690 V AC and 1 000 V DC by means of a voltage reducer module
- For AC supply systems: Frequency range 15 to 400 Hz
- Monitoring of broken conductors
- Monitoring of setting errors
- Safety in use thanks to integrated system test after startup
- Option of resetting and testing (by means of button on front or using control contact)
- New predictive measurement principle allows very fast response times

Application

IT networks are used, for example:

- In emergency power supplies
- In safety lighting systems
- In industrial production facilities with high availability requirements (chemical industry, automobile manufacturing, printing plants)
- In shipping and railways
- For mobile generators (aircraft)
- For renewable energies, such as wind energy and photovoltaic power plants
- In the mining industry

Technical specifications

More information

For manuals, see
 • <https://support.industry.siemens.com/cs/ww/en/view/54382552>
 • <https://support.industry.siemens.com/cs/ww/en/view/54382528>

Type	3UG4581-1AW30	3UG4582-1AW30	3UG4583-1CW30
General data			
Setting range for the setpoint response values			
• 1 ... 100 kΩ	✓	✓	✓
• 2 ... 200 kΩ	--	--	✓
Rated voltage of the network being monitored			
• 0 ... 250 V AC	--	✓	--
• 0 ... 440 V AC	✓	--	✓
• 0 ... 690 V AC	--	--	✓ ¹⁾
• 0 ... 300 V DC	--	✓	--
• 0 ... 600 V DC	--	--	✓
• 0 ... 1 000 V DC	--	--	✓ ¹⁾
Max. leakage capacitance of the system			
• 10 μF	✓	✓	--
• 20 μF	--	--	✓
Output contacts			
• 1 CO	✓	✓	--
• 2 CO or 1 CO + 1 CO, adjustable	--	--	✓
Number of limit values			
• 1	✓	✓	--
• 1 or 2, adjustable	--	--	✓
Principle of operation	Closed-circuit principle	Closed-circuit principle	Open-circuit/closed-circuit principle, adjustable
Rated control supply voltage			
• 24 ... 240 V AC/DC	✓	✓	✓
Rated frequency			
• 15 ... 400 Hz	--	✓	✓
• 50/60 Hz	✓	--	--
Auto or Manual RESET	✓ Adjustable	✓ Adjustable	✓ Adjustable
Remote RESET	✓ Via control input	✓ Via control input	✓ Via control input
Non-volatile error memory	--	--	✓ Adjustable
Broken wire detection	--	--	✓ Adjustable
Replacement for			
Rated control supply voltage U_s	Voltage range of the network being monitored		
3UG3081-1AK20 110 ... 130/220 ... 240 V AC/DC	3 x 230/400 V AC	✓	--
3UG3081-1AW30 24 ... 240 V AC/DC	3 x 230/400 V AC	✓	--
3UG3082-1AW30 24 ... 240 V AC/DC	24 ... 240 V DC	--	✓

✓ Available
 -- Not available

¹⁾ With voltage reducer module.

Overview



SIRIUS 3UG4581 insulation monitor

The 3UG4581 insulation monitoring relays are used to monitor insulation resistance according to IEC 61557-8 in ungrounded AC networks with rated voltages of up to 400 V.

These devices can monitor control circuits (single-phase) and main circuits (three-phase).

They measure insulation resistances between system cables and system ground. If the value falls below the threshold value, the output relays are switched to fault status.

In the case of 3UG4581 a higher-level DC measuring signal is used. The higher-level DC measuring signal and the resulting current are used to determine the value of the insulation resistance of the network which is to be measured.

Technical specifications

3UG4581 monitoring relay

With the closed-circuit principle selected

Insulation resistance monitoring without fault storage, with Auto RESET

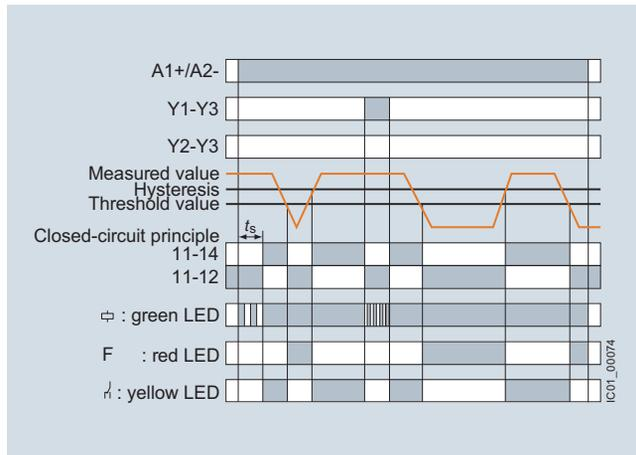

Insulation resistance monitoring with fault storage and Manual RESET

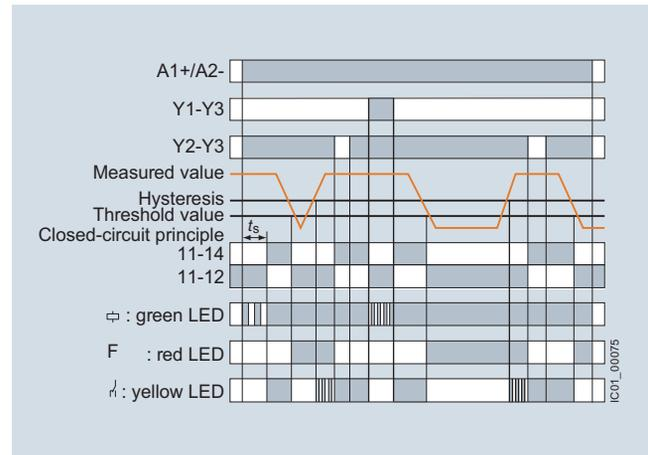

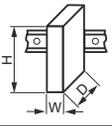
Type	3UG4581	
Dimensions (W x H x D)	mm	22.5 x 100 x 100
		
Connection type	Screw terminals	
• Solid	mm ²	2 x (0.5 ... 4)
• Finely stranded with end sleeve	mm ²	2 x (0.75 ... 2.5)
• AWG cables, solid or stranded	AWG	2 x (20 ... 14)
General data		
Rated insulation voltage U_i	V	400 supply circuit/measuring circuit
Pollution degree 3		300 supply circuit/output circuit
Overvoltage category III acc. to IEC 60664		
Rated impulse withstand voltage U_{imp}	kV	6
Rated control supply voltage	V	24 ... 240 AC/DC
Rated frequency	Hz	15 ... 400
Measuring circuit		
Rated line voltage of the network being monitored	V	0 ... 400
Rated frequency of the network being monitored	Hz	50 ... 60
Setting range for insulation resistance	k Ω	1 ... 100
Control circuit		
Load capacity of the output relay		
• Thermal current I_{th}	A	4
Rated operational current I_e at		
• AC-15/24 ... 400 V	A	3
• DC-13/24 V	A	2
Minimum contact load at 24 V DC	mA	10

Selection and ordering data

- Auto or Manual RESET
- Closed-circuit principle
- 1 CO contact
- Fault memory adjustable using control input (Y2-Y3)
- Reset by means of button on front or using control input (Y2-Y3)
- Test by means of button on front or using control input (Y1-Y3)

Rated line voltage U_n	Measuring range U_e	Rated control supply voltage U_s	System leakage capacitance	SD	Screw terminals	PU (UNIT, SET, M)	PS*
V AC	k Ω	V	μ F	d	Article No.	Price per PU	

Insulation monitors for ungrounded AC networks

0 ... 400	1 ... 100	24 ... 240 AC/DC	Max. 10	5	3UG4581-1AW30	1	1 unit
-----------	-----------	------------------	---------	---	----------------------	---	--------



3UG4581-1AW30

For accessories, see page 11/85

3UG45, 3UG46 Monitoring Relays for Stand-Alone Installation

Insulation monitoring for ungrounded DC and AC networks

Overview



SIRIUS 3UG4582 and 3UG4583 insulation monitors

The 3UG4582 and 3UG4583 insulation monitoring relays are used to monitor insulation resistance in ungrounded IT AC or DC networks according to IEC 61557-8.

They measure insulation resistances between system cables and system ground. If the value falls below the threshold value, the output relays are switched to fault status. With these devices, which are suitable for both AC and DC networks, a pulsed test signal is fed into the network to be monitored and the isolation resistance is determined.

The pulsed test signal changes its form according to insulation resistance and network loss capacitance. The changed form is used to predict the changed insulation resistance.

If the predicted insulation resistance matches the insulation resistance calculated in the next measurement cycle, and is lower than the threshold value, the output relays are activated or deactivated, depending on the device configuration. This measurement principle is also suitable for identifying symmetrical insulation faults.

3UG4983 voltage reducer module

The 3UG4983 passive voltage reducer module can be used to allow the 3UG4583 insulation monitoring relay to be used for insulation monitoring of IT networks with rated voltages of up to 690 V AC and 1 000 V DC.

Technical specifications

3UG4582 monitoring relays

With the closed-circuit principle selected

Insulation resistance monitoring without fault storage, with Auto RESET

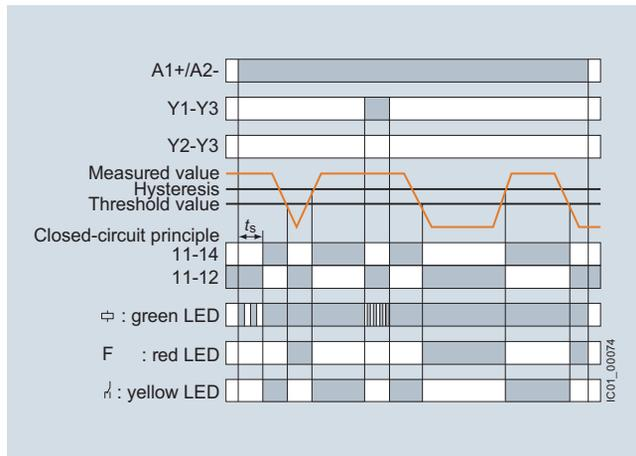

Insulation resistance monitoring with fault storage and Manual RESET

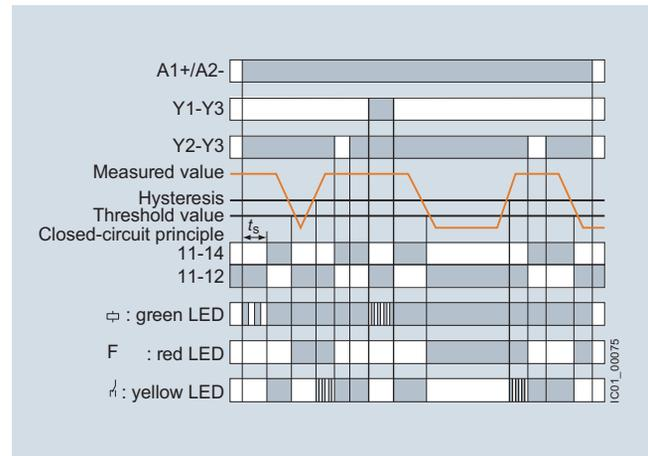

3UG4583 monitoring relays

With the closed-circuit principle selected

Insulation resistance monitoring without fault storage, with Auto RESET

Insulation resistance monitoring with fault storage and Manual RESET

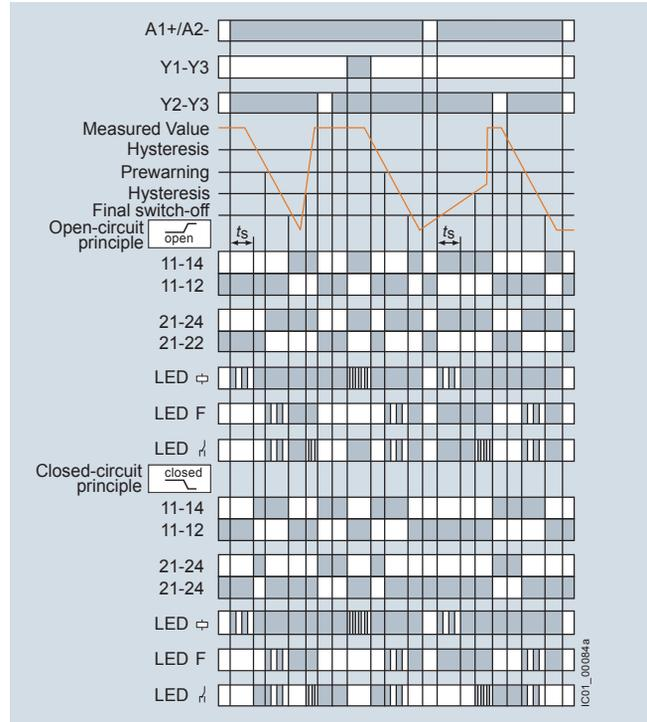
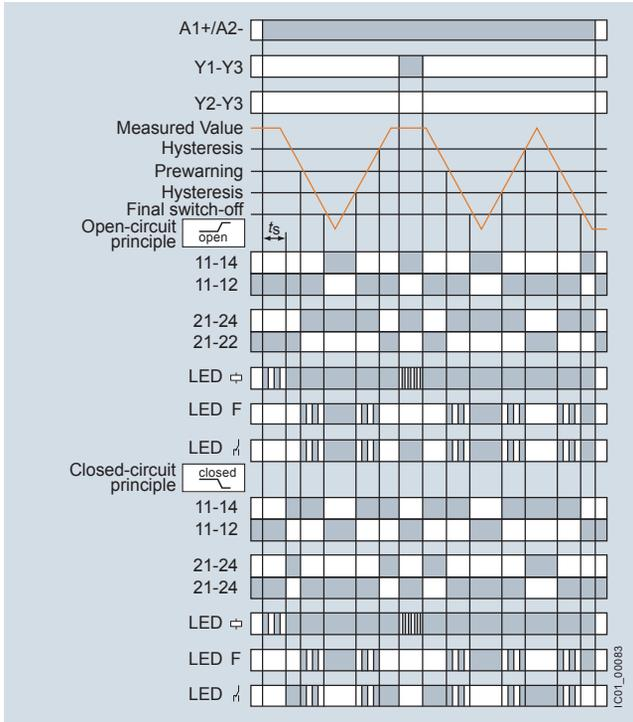

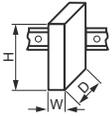
Type		3UG4582	3UG4583
Dimensions (W x H x D)	 mm	22.5 x 100 x 100	45 x 100 x 100
Connection type		⚙️ Screw terminals	
		mm ²	2 x (0.5 ... 4)
		mm ²	2 x (0.75 ... 2.5)
		AWG	2 x (20 ... 14)
General data			
Rated insulation voltage U_i	V	400 supply circuit/measuring circuit, 300 supply circuit/output circuit	400 supply circuit/measuring circuit, 300 supply circuit/output circuit, 300 output circuit 1/output circuit 2
Pollution degree 3 Overvoltage category III acc. to IEC 60664			
Rated impulse withstand voltage U_{imp}	kV	6	
Rated control supply voltage	V AC/DC	24 ... 240	
Rated frequency	Hz	15 ... 400	
Measuring circuit			
Rated line voltage of the network being monitored	V	0 ... 250 AC, 0 ... 300 DC	0 ... 300 AC, 0 ... 690 AC with 3UG49 83 0 ... 600 DC, 0 ... 1 000 DC with 3UG49 83
Rated frequency of the network being monitored	Hz	DC or 15 ... 400	
Setting range for insulation resistance	k	1 ... 100	1 ... 100, 2 ... 200 for 2nd limit value (disconnectable)
Control circuit			
Number of CO contacts for auxiliary contacts		1	2 or 1 + 1, adjustable
Load capacity of the output relay			
• Thermal current I_{th}	A	4	
Rated operational current I_e at			
• AC-15/24 ... 400 V	A	3	
• DC-13/24 V	A	2	
Minimum contact load at 24 V DC	mA	10	

Selection and ordering data

- Auto or Manual RESET
- Rated control supply voltage U_s 24 ... 240 V AC/DC
- 3UG4582: Closed-circuit principle
3UG4583: Open-circuit or closed-circuit principle, adjustable
- 1 or 2 CO contacts
- Fault memory adjustable using control input (Y2-Y3)
- Reset by means of button on front or using control input (Y2-Y3)
- Test by means of button on front or using control input (Y1-Y3)
- 3UG4583: Non-volatile fault storage can be configured
- 3UG4583: 2 separate limit values (e.g. for warning and disconnection) or 2 CO contacts for one limit value (e.g. for a local alarm and signaling to the PLC via separate circuits) can be configured

Note:

With the 3UG4983-1A coupling unit, connection to networks with voltages of up to 690 V AC and 1 000 V DC is possible, [see below](#).

	Rated line voltage U_n	System leakage capacitance	Output relays	Measuring range U_e	Broken wire detection in the measuring range	SD	Screw terminals	PU (UNIT, SET, M)	PS*
	V	μF		k Ω		d	Article No.	Price per PU	
3UG4582 insulation monitors									
 3UG4582-1AW30	0 ... 250 AC, 0 ... 300 DC	Max. 10	1 CO	1 ... 100	✓	5	3UG4582-1AW30		1 1 unit
3UG4583 insulation monitors									
 3UG4583-1CW30	0 ... 400 AC, 0 ... 600 DC ¹⁾	Max. 20	2 CO or 1 CO + 1 CO, adjustable	1 ... 100, 2 ... 200 for 2nd limit value, adjustable	✓ Adjustable	5	3UG4583-1CW30		1 1 unit
Voltage reducer module for 3UG4583									
 3UG4983-1A	For extending the network voltage range to max. 690 V AC and 1 000 V DC					5	3UG4983-1A		1 1 unit

✓ Available

¹⁾ With 3UG4983-1A voltage reducer module suitable also for the insulation monitoring of IT networks of up to 690 V AC and 1 000 V DC.

For accessories, [see page 11/85](#)

Overview



SIRIUS 3UG4501 monitoring relay

The 3UG4501 level monitoring relay is used in combination with 2- or 3-pole sensors to monitor the levels of conductive liquids.

Benefits

- Can be used worldwide thanks to wide voltage range from 24 to 240 V (absolute limit values)
- Individually shortenable 2- and 3-pole wire electrodes for easy mounting from above/below
- Bow electrodes for installation from the side, for larger filling levels and minimum space requirements
- Can be flexibly adapted to different conductive liquids through analog setting of the sensitivity from 2 to 200 kΩ
- Compensation for wave movements through tripping delay times from 0.1 to 10 s
- Upstream or downstream function selectable
- All versions with removable terminals
- All versions with screw or spring-type terminals

Application

- Single-point and two-point level monitoring
- Overflow protection
- Dry run protection
- Leak monitoring

Technical specifications

3UG4501 monitoring relays

The principle of operation of the 3UG4501 level monitoring relay is based on measuring the electrical resistance of the liquid between two immersion sensors and a reference terminal. If the measured value is lower than the sensitivity set at the front, the output relay changes its switching state. In order to exclude electrolytic phenomena in the liquid, the sensors are supplied with alternating current.

Two-point control

The output relay changes its switching state as soon as the liquid level reaches the maximum sensor, while the minimum sensor is submerged. The relay returns to its original switching state as soon as the minimum sensor no longer has contact with the liquid.

OVER, two-point control

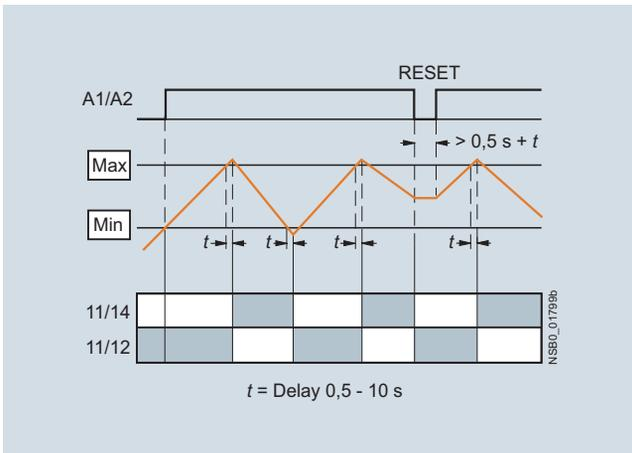

UNDER, two-point control

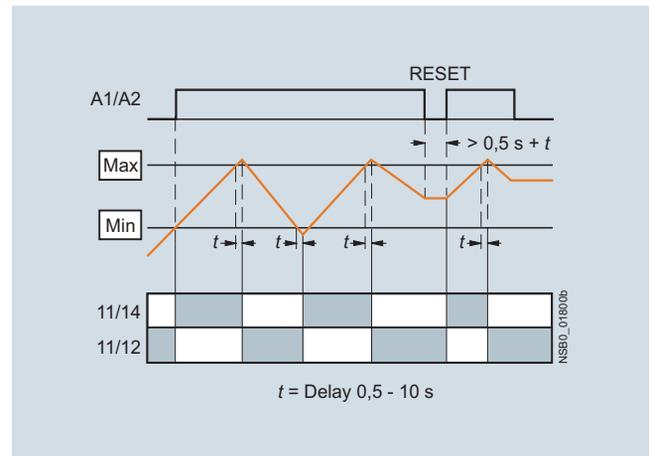

Note:

It is also possible to connect other resistance sensors to the Min and Max terminals in the range 2 to 200 kΩ, e.g. photoresistors, temperature sensors, encoders based on resistance, etc. The monitoring relay can therefore also be used for other applications as well as for monitoring the levels of liquids.

Single-point control

If only one level is being controlled, the terminals for Min and Max on the monitoring relay are bridged. The output relay changes its switching state as soon as the liquid level is reached and returns to its original switching state once the sensor no longer has contact with the liquid.

In order to prevent premature tripping of the switching function caused by wave motion or frothing, even though the set level has not been reached, it is possible to delay this function by 0.5 to 10 s.

For safe resetting, the control supply voltage must be interrupted for at least the set delay time of +0.5 s.

OVER, single-point control

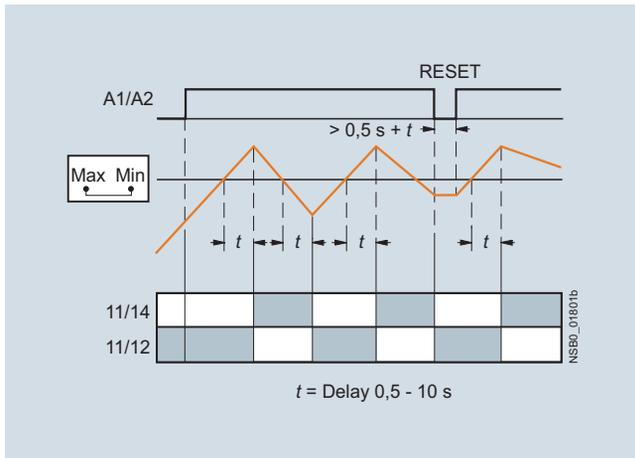

UNDER, single-point control

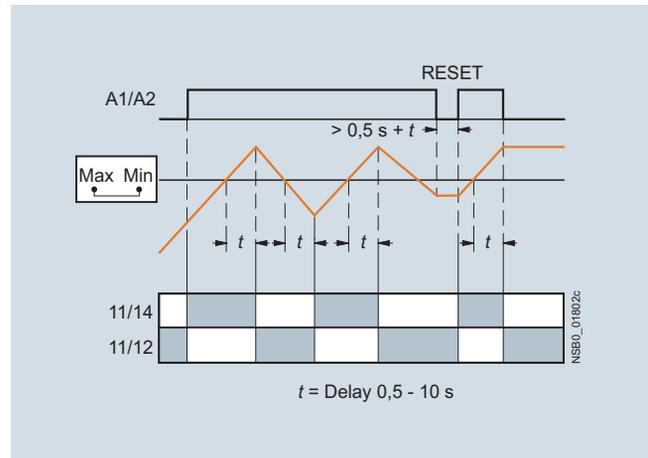

Type	3UG4501	
General data		
Rated insulation voltage U_i	V	300
Pollution degree 3 Overvoltage category III acc. to VDE 0110		
Rated impulse withstand voltage U_{imp}	kV	4
Measuring circuit		
Electrode current, max. (typ. 70 Hz)	mA	1
Electrode voltage, max. (typ. 70 Hz)	V	15
Sensor feeder cable	m	Max. 100
Conductor capacitance of sensor cable¹⁾	nF	Max. 10
Control circuit		
Load capacity of the output relay		
Thermal current I_{th}	A	5
Rated operational current I_e at		
• AC-15/24 ... 400 V	A	3
• DC-13/24 V	A	1
• DC-13/125 V	A	0.2
• DC-13/250 V	A	0.1
Minimum contact load at 17 V DC	mA	5

¹⁾ The sensor cable does not necessarily have to be shielded, but we do not recommend installing this cable parallel to the power supply lines. It is also possible to use a shielded cable, whereby the shield has to be connected to the M terminal.

Selection and ordering data

- For level monitoring of electrically conductive liquids
- Control principle: inlet or sequence control adjustable per rotary switch
- Single-point and two-point control possible
- Analogically adjustable sensitivity (specific resistance of the liquid)
- Analogically adjustable tripping delay time
- 1 yellow LED for displaying the relay state
- 1 green LED for displaying the applied control supply voltage
- 1 CO contact

PU (UNIT, SET, M) = 1
PKG* = 1 UNIT

Sensitivity	Tripping delay time	Rated control supply voltage U_s	SD	Screw terminals 		SD	Spring-type terminals 	
				Article No.	Price per PU		Article No.	Price per PU
kΩ	s	V	d	3UG4501-1AA30	2	3UG4501-2AA30	2	3UG4501-2AA30
		AC/DC						
2 ... 200	0.5 ... 10	24 ¹⁾	2	3UG4501-1AA30	2	3UG4501-2AA30	2	3UG4501-2AA30
		24 ... 240	2	3UG4501-1AW30	2	3UG4501-2AW30	2	3UG4501-2AW30

¹⁾ The rated control supply voltage and the measuring circuit are not electrically separated.

For accessories, see [page 11/85](#)

Overview



SIRIUS 3UG4651 monitoring relay

The 3UG4651 monitoring relay is used in combination with a sensor to monitor motor drives for overspeed and/or under-speed.

Furthermore, the monitoring relay is ideal for all functions where a continuous pulse signal needs to be monitored (e.g. belt travel monitoring, completeness monitoring, passing monitoring, clock-time monitoring).

Benefits

- Can be used worldwide thanks to wide voltage range from 24 to 240 V (absolute limit values)
- Variably adjustable to overshoot, undershoot or range monitoring
- Freely configurable delay times and RESET response
- Permanent display of actual value and fault type
- Use of up to 10 sensors per rotation for extremely slowly rotating motors
- 2- or 3-wire sensors and sensors with a mechanical switching output or semiconductor output can be connected
- Auxiliary voltage for sensor integrated
- All versions with removable terminals
- All versions with screw or spring-type terminals

Application

- Slip or tear of a belt drive
- Overload monitoring
- Transport monitoring for completeness

Technical specifications

3UG4651 monitoring relay

The speed monitoring relay operates according to the principle of period duration measurement.

In the monitoring relay, the time between two successive rising edges of the pulse encoder is measured and compared to the minimum and/or maximum permissible period duration calculated from the set limit values for the speed.

Thus, the period duration measurement recognizes any deviation in speed after just two pulses, even at very low speeds or in the case of extended pulse gaps.

By using up to ten pulse encoders evenly distributed around the circumference, it is possible to shorten the period duration, and in turn the response time. By taking into account the number of sensors in the monitoring relay, the speed continues to be indicated in rpm.

ON-delay time for motor start

To be able to start a motor drive, and depending on whether the open-circuit or closed-circuit principle is selected, the output relay switches to the GO state during the ON-delay time, even if the speed is still below the set value.

The ON-delay time is started by either switching on the auxiliary voltage or, if the auxiliary voltage is already applied, by actuating the respective NC contact (e.g. auxiliary contact).

Speed monitoring with Auto RESET (Memory = no)

If the device is set to Auto RESET, the output relay switches to the GO state, once the adjustable hysteresis threshold is reached in the range of 0.1 to 99.9 rpm and the flashing stops. Any overshoots or undershoots are therefore not stored.

Speed monitoring with Manual RESET (Memory = yes)

If Manual RESET is selected in the menu, the output relay remains in its current switching state and the current measured value and the symbol for overshooting/undershooting continue to flash, even when the speed returns to a permissible value. This stored fault status can be reset by simultaneously pressing the UP▲ and DOWN▼ keys for > 2 s, by connecting the RESET device terminal to 24 V DC or by switching the control supply voltage off and back on again.

Speed monitoring

With the closed-circuit principle selected

Range monitoring without enable input

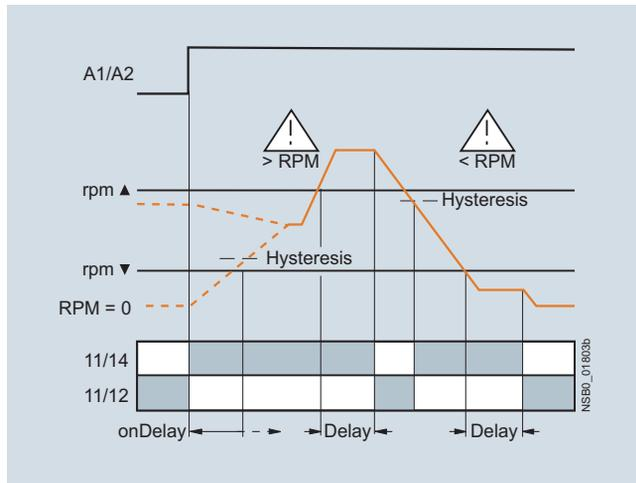

Range monitoring with enable input

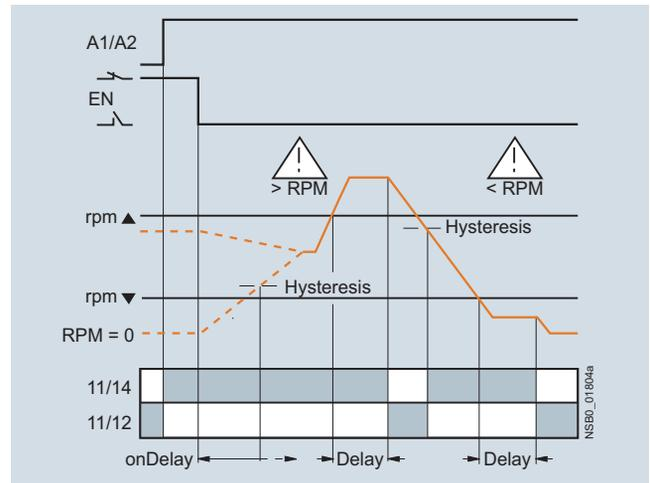

Type	3UG4651	
General data		
Rated insulation voltage U_i	V	300
Pollution degree 3 Overvoltage category III acc. to VDE 0110		
Rated impulse withstand voltage U_{imp}	kV	4
Measuring circuit		
Sensor supply		
• For 3-wire sensor (24 V/0 V)	mA	Max. 50
• For 2-wire NAMUR sensor (8V2)	mA	Max. 8.2
Signal input		
• IN1	kΩ	16, 3-wire sensor, pnp operation
• IN2	kΩ	1, floating contact, 2-wire NAMUR sensor
Voltage level		
• For level 1 at IN1	V	4.5 ... 30
• For level 0 at IN1	V	0 ... 1
Current level		
• For level 1 at IN2	mA	> 2.1
• For level 0 at IN2	mA	< 1.2
Minimum pulse duration of signal	ms	5
Minimum interval between 2 pulses	ms	5
Control circuit		
Number of CO contacts for auxiliary contacts		1
Load capacity of the output relay		
Thermal current I_{th}	A	5
Rated operational current I_e at		
• AC-15/24 ... 400 V	A	3
• DC-13/24 V	A	1
• DC-13/125 V	A	0.2
• DC-13/250 V	A	0.1
Minimum contact load at 17 V DC	mA	5

Selection and ordering data

- For speed monitoring in revolutions per minute (rpm)
 - Two- or three-wire sensor with mechanical or electronic switching output can be connected
 - Two-wire NAMUR sensor can be connected
 - Sensor supply 24 V DC/50 mA integrated
 - Input frequency 0.1 to 2 200 pulses rpm (0.0017 to 36.7 Hz)
 - With or without enable signal for the drive to be monitored
 - Digitally adjustable, with illuminated LCD
 - Overshoot, undershoot or range monitoring adjustable
 - Number of pulses per revolution can be adjusted
 - Upper and lower threshold value can be adjusted separately
 - Auto, manual or remote RESET options after tripping
 - Permanent display of actual value and tripping state
 - 1 CO contact
- PU (UNIT, SET, M) = 1
 PKG* = 1 UNIT

Measuring range	Hysteresis	ON-delay time	Tripping delay time	Pulses per revolution	Rated control supply voltage U_s AC/DC	SD	Screw terminals 	SD	Spring-type terminals 		
rpm	rpm	s	s		V	d	Article No.	Price per PU	d	Article No.	Price per PU
0.1 ... 2 200	OFF 0.1 ... 99.9	0 ... 900	0.1 ... 99.9	1 ... 10	24 ¹⁾	2	3UG4651-1AA30	2	3UG4651-2AA30		
					24 ... 240	2	3UG4651-1AW30	2	3UG4651-2AW30		

¹⁾ The rated control supply voltage and the measuring circuit are not electrically separated.

For accessories, see page 11/85

Selection and ordering data

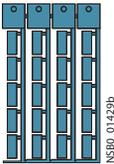
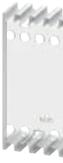
Use	Version	SD	Article No.	Price per PU	PU (UNIT, SET, M)	PS*
Blank labels						
 3RT1900-1SB20	For 3UG4		Unit labeling plates For SIRIUS devices 20 mm x 7 mm, pastel turquoise	20	3RT1900-1SB20	100 340 units
	For 3UG4		Adhesive labels for SIRIUS devices	15	3RT1900-1SB60	100 3 060 units
			<ul style="list-style-type: none"> • 19 mm x 6 mm, pastel turquoise • 19 mm x 6 mm, zinc yellow 	15	3RT1900-1SD60	100 3 060 units
Push-in lugs and covers						
 3RP1903	For 3UG4		Push-in lugs For screw fixing, 2 units are required for each device	5	3RP1903	1 10 units
	 3RP1902	For 3UG4		Sealable covers For securing against unauthorized adjustment of setting knobs	5	3RP1902
For 3UG45			Sealing foil For securing against unauthorized adjustment of setting knobs	▶	3TK2820-0AA00	1 1 unit
Covers for insulation monitoring relays						
 3UG4981-0C	For 3UG4581 and 3UG4582		Sealable, transparent covers	5	3UG4981-0C	1 1 unit
	For 3UG4583			5	3UG4983-0C	1 1 unit
 3UG4983-0C						
Tools for opening spring-type terminals						
 3RA2908-1A	For auxiliary circuit connections		Screwdrivers For all SIRIUS devices with spring-type terminals; 3.0 mm x 0.5 mm; length approx. 200 mm, titanium gray/black, partially insulated	2	Spring-type terminals 	
					3RA2908-1A	1 1 unit

Note:

For products for mechanical bearing monitoring, e.g. condition monitoring systems, see www.siemens.com/siplus-cms.

Overview



SIRIUS 3UG48 monitoring relays

More information

Homepage, see www.usa.siemens.com/relays

Industry Mall, see www.siemens.com/product?3UG48

For the conversion tool, e.g. from 3UG3 to 3UG4, see www.siemens.com/sirius/conversion-tool

The SIRIUS 3UG4 monitoring relays for electronic and mechanical variables monitor all important characteristics that allow conclusions to be drawn about the functionality of a plant. Both sudden disturbances and gradual changes, which may indicate the need for maintenance, are detected.

Thanks to their relay outputs, the monitoring relays permit direct disconnection of the affected system components and alerting, e.g. by the triggering of a warning light. Thanks to adjustable delay times the 3UG4 monitoring relays can respond very flexibly to brief faults such as voltage dips or load changes and can thus avoid unnecessary alarms and disconnections and increase system availability.

3UG48 monitoring relays for IO-Link

The SIRIUS 3UG48 monitoring relays for IO-Link also offer many other options based upon the monitoring functions of the tried-and-tested SIRIUS 3UG4 monitoring relays:

- Measured value transmission to a controller, including resolution and unit, may be parameterizable as to which value is cyclically transmitted
- Transmission of alarm flags to a controller
- Full diagnosis capability by inquiry as to the cause of the fault in the diagnosis data record
- Remote parameterization is also possible, in addition to or instead of local parameterization
- Rapid parameterization of the same devices by duplication of the parameterization in the controller
- Parameter transmission through uploading to a controller by IO-Link call or by parameter server (if IO-Link master from IO-Link Specification V1.1 and higher is used)
- Consistent central data storage in the event of parameter change locally or via a controller
- Automatic reparameterizing when devices are exchanged
- Blocking of local parameterization via IO-Link possible
- Faults are saved in parameterizable and non-volatile fashion to prevent an automatic start up after voltage failure and to make sure diagnostics data is not lost

- Integration into the automation level provides the option of parameterizing the monitoring relays at any time via a display unit, or displaying the measured values in a control room or locally at the machine/control cabinet

Even without communication via IO-Link the devices continue to function fully autonomously:

- Parameterization can take place locally at the device, independently of a controller.
- In the event of failure or before the controller becomes available the monitoring relays work as long as the control supply voltage (24 V DC) is present.
- If the monitoring relays are operated without the controller, the 3UG48 monitoring relays have, thanks to the integrated SIO mode, an additional semiconductor output, which switches when the adjustable warning threshold is exceeded.

Thanks to the combination of autonomous monitoring relay function and integrated IO-Link communication, redundant sensors and/or analog signal converters – which previously took over the transmission of measured values to a controller, leading to considerable extra cost and wiring outlay – are no longer needed.

Because the output relays are still present, the monitoring relays increase the functional reliability of the system, since only the controller can fulfill the control tasks if the current measured values are available, whereas the output relays can also be used for the disconnection of the system if limit values that cannot be reached during operation are exceeded.

The individual 3UG48 monitoring relays for IO-Link offer the following functions in different combinations:

- Phase sequence
- Phase failure, neutral conductor failure
- Phase asymmetry
- Undershooting and/or overshooting of limit values for voltage
- Undershooting and/or overshooting of limit values for current
- Undershooting and/or overshooting of power factor limit values
- Monitoring of the active current or the apparent current
- Monitoring of the residual current
- Undershooting and/or overshooting of limit values for speed

Note:

For more information on the IO-Link bus system, [click here](#).

Notes on security

In order to protect plants, systems, machines and networks against cyber threats, it is necessary to implement – and continuously maintain – a holistic, state-of-the-art industrial security concept. Siemens products and solutions represent only one component of such a concept.

For more information on Industrial Security, see www.usa.siemens.com/industrialsecurity.

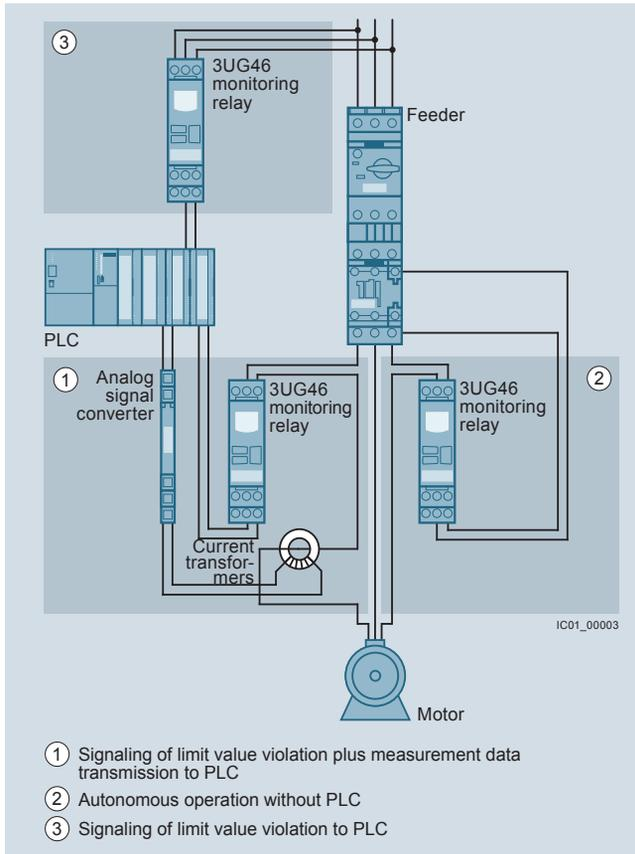

Use of conventional monitoring relays

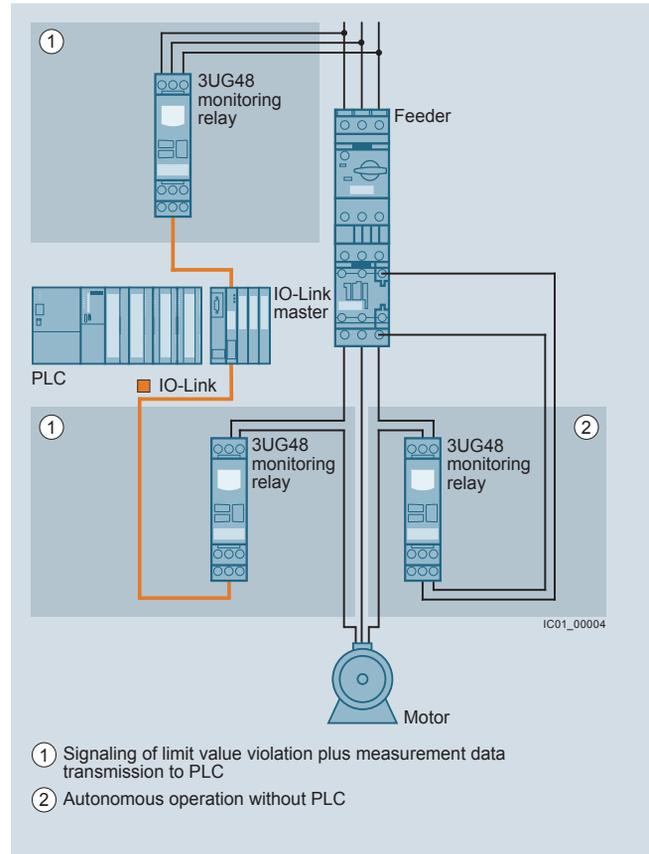

Monitoring relays for IO-Link

Notes:

- Devices required for the communication via IO-Link:
- Any controller that supports the IO-Link (e.g. ET 200SP with CPU or S7-1200).
 - IO-Link master (e.g. CM 4xIO-Link for SIMATIC ET 200SP or SM 1278 for S7-1200).

Each monitoring relay requires an IO-Link channel.

Article No. scheme

Product versions		Article number	
3UG4 monitoring relay with IO-Link		3UG4	<input type="checkbox"/> <input type="checkbox"/> <input type="checkbox"/> - <input type="checkbox"/> <input type="checkbox"/> <input type="checkbox"/> <input type="checkbox"/> 0
Type of setting	e.g. 8 = analogically adjustable	<input type="checkbox"/>	
Functions	e.g. 15 = line monitoring	<input type="checkbox"/> <input type="checkbox"/>	
Connection type	Screw terminals		1
	Spring-type terminals (push-in)		2
Contacts	e.g. A = 1 CO contact	<input type="checkbox"/>	
Supply voltage	e.g. A4 = 160 ... 690 V AC		<input type="checkbox"/> <input type="checkbox"/>
Example		3UG4	8 1 5 - 1 A A 4 0

Note:

The Article No. scheme shows an overview of product versions for better understanding of the logic behind the article numbers.

For your orders, please use the article numbers quoted in the selection and ordering data.

Benefits

- Simple cyclical transmission of the current measured values, relay switching states and events to a controller
- Remote parameterization
- Automatic reparameterizing when devices are exchanged
- Simple duplication of identical or similar parameterizations
- Reduction of control current wiring
- Elimination of testing costs and wiring errors
- Reduction of configuration work
- Integration in TIA means clear diagnostics if a fault occurs
- Cost saving and space saving in control cabinet due to the elimination of AI and IO modules as well as analog signal converters and duplicated sensors

Application

The use of SIRIUS monitoring relays for IO-Link is particularly recommended for machines and plants in which these relays, in addition to their monitoring function, are to be connected to the automation level for the rapid, simple and fault-free provision of the current measured values and/or for remote parameterization.

The monitoring relays can either relieve the controller of monitoring tasks or, as a second monitoring entity in parallel to and independent of the controller, increase the reliability in the process or in the system. In addition, the elimination of AI and IO modules allows the width of the controller to be reduced despite significantly expanded functionality.

Technical specifications

More information	
Technical specifications, see https://support.industry.siemens.com/cs/ww/en/ps/16368/td Manual and internal circuit diagrams, see https://support.industry.siemens.com/cs/ww/en/view/54375430	FAQs, see https://support.industry.siemens.com/cs/ww/en/ps/16368/faq

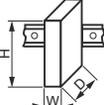
Type	3UG48	
General technical specifications		
Dimensions (W x H x D)		
<ul style="list-style-type: none"> For 3 terminal blocks <ul style="list-style-type: none"> - Screw terminals - Spring-type terminals For 4 terminal blocks <ul style="list-style-type: none"> - Screw terminals - Spring-type terminals 		mm 22.5 x 92 x 91
		mm 22.5 x 94 x 91
	mm 22.5 x 103 x 91	mm 22.5 x 103 x 91
Permissible ambient temperature		
• During operation	°C	-25 ... +60
Connection type		 Screw terminals
<ul style="list-style-type: none"> Terminal screw Solid Finely stranded with end sleeve AWG cables, solid or stranded Tightening torque 	mm ²	M3 (for standard screwdriver, size 2 and Pozidriv 2)
	mm ²	1 x (0.5 ... 4), 2 x (0.5 ... 2.5)
	AWG	1 x (0.5 ... 2.5), 2 x (0.5 ... 1.5)
	Nm	2 x (20 ... 14) 0.8 ... 1.2
Connection type		 Spring-type terminals
<ul style="list-style-type: none"> Solid Finely stranded, with end sleeve acc. to DIN 46228 Finely stranded AWG cables, solid or stranded 	mm ²	2 x (0.25 ... 1.5)
	mm ²	2 x (0.25 ... 1.5)
	mm ²	2 x (0.25 ... 1.5)
	AWG	2 x (24 ... 16)

Overview



SIRIUS 3UG4815 monitoring relay

Solid-state line monitoring relays provide maximum protection for mobile machines, plants and hoisting equipment or for unstable networks. Network and voltage faults can thus be detected early and rectified before far greater damage ensues.

The line monitoring relays with IO-Link monitor phase sequence, phase failure (with or without N conductor monitoring), phase asymmetry and undervoltage and/or overvoltage.

Phase asymmetry is evaluated as the difference between the greatest and the smallest phase voltage relative to the greatest phase voltage. Undervoltage or overvoltage exist if the set limit values for at least one phase voltage are overshoot or undershot. The rms value of the voltage is measured.

Benefits

- Can be used in any network from 160 to 630 V AC worldwide thanks to wide voltage range
- Variably adjustable to overshoot, undershoot or range monitoring
- Freely configurable delay times and RESET response
- Width 22.5 mm
- Display and transmission of actual value and network fault type to controller
- All versions with removable terminals
- All versions with screw or spring-type terminals

Application

The relays are used above all for mobile equipment, e.g. air conditioning compressors, refrigerating containers, building site compressors and cranes.

Function	Application
Phase sequence	<ul style="list-style-type: none"> • Direction of rotation of the drive
Phase failure	<ul style="list-style-type: none"> • A fuse has tripped • Failure of the control supply voltage • Broken cable
Phase asymmetry	<ul style="list-style-type: none"> • Overheating of the motor due to asymmetrical voltage • Detection of asymmetrically loaded networks
Undervoltage	<ul style="list-style-type: none"> • Increased current on a motor with corresponding overheating • Unintentional resetting of a device • Network collapse, particularly with battery power
Oversvoltage	<ul style="list-style-type: none"> • Protection of a plant against destruction due to overvoltage

Technical specifications

3UG4815/3UG4816 monitoring relays

The 3UG4815 and 3UG4816 line monitoring relays have a wide voltage range input and are supplied with power through IO-Link or from an external 24 V DC source.

The device is equipped with a display and is parameterized using three buttons. The 3UG4815 monitoring relay monitors three-phase networks with regard to phase sequence, phase failure, phase asymmetry, undervoltage and overvoltage. The 3UG4816 monitoring relay monitors the neutral conductor as well. The hysteresis is adjustable from 1 to 20 V.

The device has two separately adjustable delay times for overvoltage and undervoltage and for line stabilization. If the direction of rotation is incorrect or a phase fails, the device switches off immediately. Thanks to a special measuring method, a phase failure is reliably detected in spite of the wide voltage range from and potentially high feedback through the load.

The 3UG4815 and 3UG4816 monitoring relays can be operated on the basis of either the open-circuit or closed-circuit principle and with Manual or Auto RESET.

If Manual RESET is selected in the menu (Memory = Yes), the switching relay remains in its current switching state and the current measured value and the symbol for undershooting and overshooting continues to flash, even when the measured variable reaches a permissible value again. This stored fault status can be reset by simultaneously pressing the UP▲ and DOWN▼ keys for 2.5 s.

With Manual RESET through IO-Link it is possible in addition to set whether error signals are to be deleted when the control supply voltage is switched off and on (as remote RESET) or whether the signals are to be permanently saved even in a voltage failure, with confirmation possible only through local RESET or via IO-Link.

With the closed-circuit principle selected

Wrong phase sequence

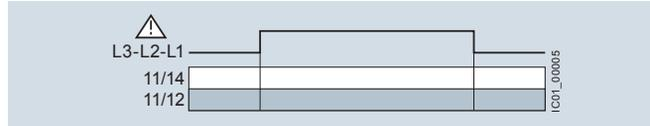

Phase failure

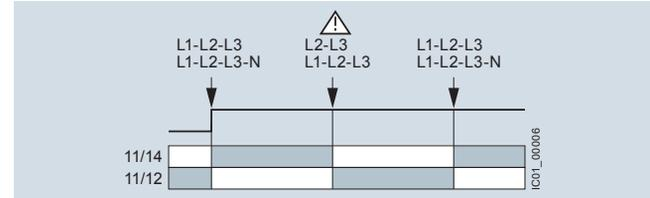

Undervoltage

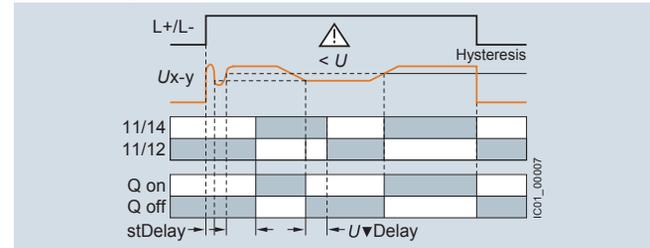

Overvoltage

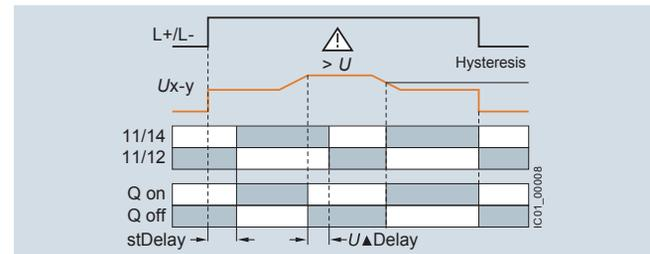

Type	3UG4815, 3UG4816	
General technical specifications		
Rated insulation voltage U_i	V	690
Pollution degree 2 Overvoltage category III acc. to VDE 0110		
Rated impulse withstand voltage U_{imp}	kV	6
Control circuit		
Load capacity of the output relay		
• Thermal current I_{th}	A	5
Rated operational current I_e at		
• AC-15/24 ... 400 V	A	3
• DC-13 at		
- 24 V	A	1
- 125 V	A	0.2
- 250 V	A	0.1
Minimum contact load at 17 V DC	mA	5
Electrical endurance AC-15	Million operating cycles	0.1
Mechanical endurance	Million operating cycles	10

3UG48 Monitoring Relays for Stand-Alone Installation for IO-Link

Line monitoring

Selection and ordering data

- Adjustable via IO-Link and locally, with illuminated LCD
- Power supply with 24 V DC via IO-Link or external auxiliary voltage
- Auto or Manual RESET
- Open- or closed-circuit principle
- 1 CO contact, 1 semiconductor output (in SIO mode)

PU (UNIT, SET, M) = 1
 PKG* = 1 UNIT

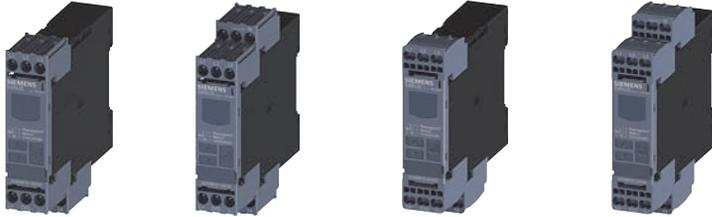

3UG4815-1AA40 3UG4816-1AA40 3UG4815-2AA40 3UG4816-2AA40

Adjustable hysteresis	Under-voltage detection	Over-voltage detection	Stabilization time adjustable stDEL	Tripping delay time adjustable Del	Version of auxiliary contacts	Measurable line voltage ¹⁾	SD	Screw terminals	SD	Spring-type terminals	
V			s	s		VAC	d	Article No.	Price per PU	Article No.	Price per PU
Monitoring of phase sequence, phase failure, phase asymmetry, overvoltage and undervoltage											
1 ... 20	✓	✓	0.1 ... 999.9	0.1 ... 999.9	1 CO + 1 Q ²⁾	160 ... 690	2	3UG4815-1AA40	2	3UG4815-2AA40	
Monitoring of phase sequence, phase and N conductor failure, phase asymmetry, overvoltage and undervoltage											
1 ... 20	✓	✓	0.1 ... 999.9	0.1 ... 999.9	1 CO + 1 Q ²⁾	90 ... 400 to N	2	3UG4816-1AA40	2	3UG4816-2AA40	

✓ Function supported

¹⁾ Absolute limit values.

²⁾ In SIO mode.

For accessories, see page 11/108

Overview



SIRIUS 3UG4832 monitoring relays

The relays monitor single-phase AC voltages (rms value) and DC voltages against the set limit value for overshoot and undershoot.

Benefits

- Variably adjustable to overshoot, undershoot or range monitoring
- Freely configurable delay times and RESET response
- Width 22.5 mm
- Display and transmission of actual value and status messages to controller
- All versions with removable terminals
- All versions with screw or spring-type terminals

Application

- Protection of a plant against destruction due to overvoltage
- Switch-on of a plant at a defined voltage and higher
- Protection from undervoltage due to overloaded control supply voltages, particularly with battery power

Technical specifications

3UG4832 monitoring relays

The 3UG4832 voltage monitoring relays are supplied with power through IO-Link or with an external auxiliary voltage of 24 V DC and perform overshoot, undershoot or range monitoring of the voltage depending on parameterization. The devices are equipped with a display and are parameterized by means of three buttons or through IO-Link.

The measuring range extends from 10 to 600 V AC/DC. The limit values for overshoot or undershoot can be freely configured within this range. If one of these limit values is reached, the output relay responds according to the set principle of operation as soon as the delay time has elapsed. This tripping delay time $U\Delta$ Del/ $U\nabla$ Del can be set from 0 to 999.9 s, as can the ON-delay time onDel. The hysteresis is adjustable from 0.1 to 300 V.

The device can be operated on the basis of either the open-circuit or closed-circuit principle and with Manual or Auto RESET. One output changeover contact is available as a signaling contact, and a semiconductor output is available in addition in SIO mode.

If Manual RESET is selected in the menu (Memory = Yes), the switching relay remains in its current switching state and the current measured value and the symbol for undershooting and overshooting continues to flash, even when the measured variable reaches a permissible value again. This stored fault status can be reset by simultaneously pressing the UP \blacktriangle and DOWN \blacktriangledown keys for 2.5 s.

With Manual RESET through IO-Link it is possible in addition to set whether error signals are to be deleted when the control supply voltage is switched off and on (as remote RESET) or whether the signals are to be permanently saved even in a voltage failure, with confirmation possible only through local RESET or via IO-Link.

With the closed-circuit principle selected

Overvoltage

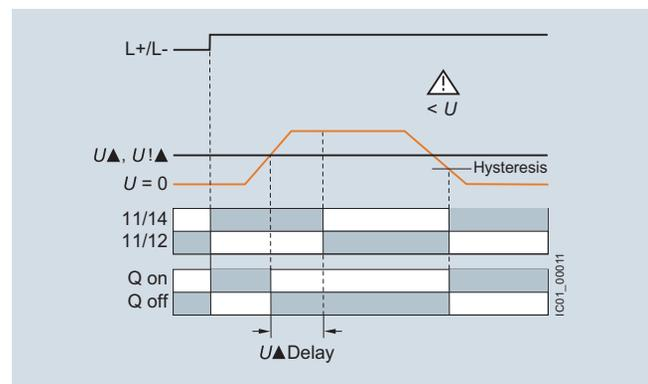

Undervoltage

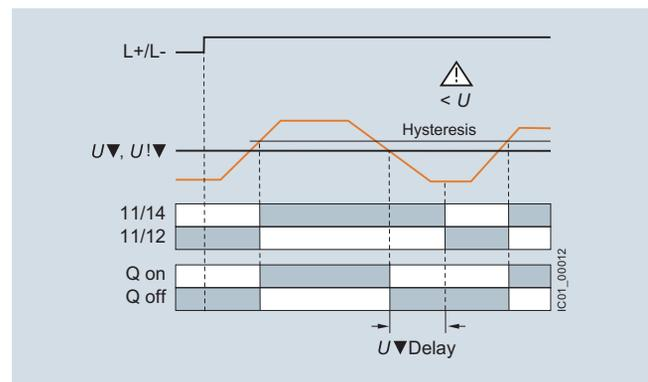

Voltage monitoring

With the closed-circuit principle selected

Range monitoring

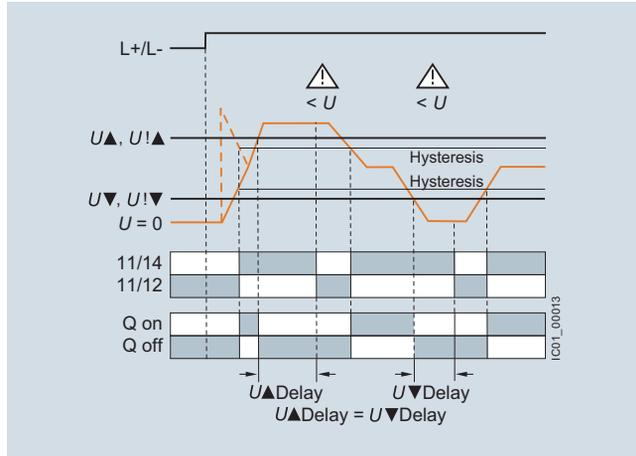

Type	3UG4832	
General technical specifications		
Rated insulation voltage U_i Pollution degree 2 Overvoltage category III acc. to VDE 0110	V	690
Rated impulse withstand voltage U_{imp}	kV	6
Measuring circuit		
Permissible measuring range single-phase AC/DC voltage	V	10 ... 690
Measuring frequency	Hz	40 ... 500
Setting range single-phase voltage	V	10 ... 600
Control circuit		
Load capacity of the output relay • Thermal current I_{th}	A	5
Rated operational current I_e at • AC-15/24 ... 400 V • DC-13 at	A	3
- 24 V	A	1
- 125 V	A	0.2
- 250 V	A	0.1
Minimum contact load at 17 V DC	mA	5

3UG48 Monitoring Relays for Stand-Alone Installation for IO-Link

Voltage monitoring

Selection and ordering data

- Adjustable via IO-Link and locally, with illuminated LCD
 - Power supply with 24 V DC via IO-Link or external auxiliary voltage
 - Auto or Manual RESET
 - Open- or closed-circuit principle
 - 1 CO contact, 1 semiconductor output (in SIO mode)
- PU (UNIT, SET, M) = 1
 PKG* = 1 UNIT



3UG4832-1AA40



3UG4832-2AA40

Measuring range	Adjustable hysteresis	ON-delay time adjustable onDel	Tripping delay time separately adjustable $U\blacktriangle\text{Del}/U\blacktriangledown\text{Del}$	SD	Screw terminals 	SD	Spring-type terminals 	
V AC/DC	V	s	s	d	Article No.	Price per PU	Article No.	Price per PU
Monitoring of voltage for overshoot or undershoot								
10 ... 600	0.1 ... 300	0 ... 999.9	0 ... 999.9	2	3UG4832-1AA40	2	3UG4832-2AA40	

For accessories, see page 11/108.

Overview



SIRIUS 3UG4822 monitoring relays

The relays monitor single-phase AC (rms value) and DC currents against the set limit value for overshoot and undershoot.

Benefits

- Variably adjustable to overshoot, undershoot or range monitoring
- Freely configurable delay times and RESET response
- Width 22.5 mm
- Display and transmission of actual value and status messages to controller
- All versions with removable terminals
- All versions with screw or spring-type terminals

Application

- Overcurrent and undercurrent monitoring
- Monitoring the functionality of electrical loads
- Monitoring for broken conductors

Technical specifications

3UG4822 monitoring relays

The 3UG4822 current monitoring relays are supplied with power through IO-Link or with an external voltage of 24 V DC and perform overshoot, undershoot or range monitoring of the current depending on the parameterization. The devices are equipped with a display and are parameterized using three buttons.

The measuring range extends from 0.05 to 10 A. For larger AC currents the measuring range can be extended by using commercially available current transformers. Using the adjustable transformer factor, the display of the measured primary currents up to 750 A instead of the secondary currents (max. 1 A or 5 A) is possible.

The rms value of the current is measured. The limit values for overshoot or undershoot can be freely configured within this range. If one of these limit values is reached, the output relay responds according to the set principle of operation as soon as the delay time $I\blacktriangle\text{Del}/I\blacktriangledown\text{Del}$ has elapsed. This time and the ON-delay time onDel are adjustable from 0 to 999.9 s.

The hysteresis is adjustable from 0.01 to 5 A. The device can be operated with Manual or Auto RESET and on the basis of either the open-circuit or closed-circuit principle. You can decide here whether the output relay is to respond when the supply voltage $U_s = \text{ON}$ is applied, or not until the lower measuring range limit of the measuring current ($I > 50 \text{ mA}$) is reached. One output changeover contact is available as a signaling contact, and a semiconductor output is available in addition in SIO mode.

If Manual RESET is selected in the menu (Memory = Yes), the switching relay remains in its current switching state and the current measured value and the symbol for undershooting and overshooting continues to flash, even when the measured variable reaches a permissible value again. This stored fault status can be reset by simultaneously pressing the UP \blacktriangle and DOWN \blacktriangledown keys for 2.5 s.

With Manual RESET through IO-Link it is possible in addition to set whether error signals are to be deleted when the control supply voltage is switched off and on (as remote RESET) or whether the signals are to be permanently saved even in a voltage failure, with confirmation possible only through local RESET or via IO-Link.

With the closed-circuit principle selected upon application of the control supply voltage

Current overshoot

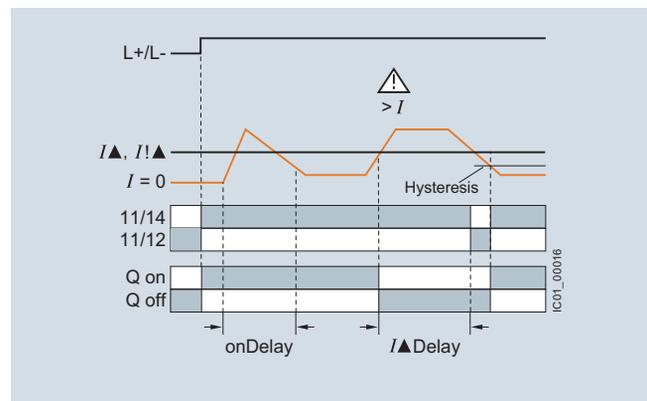

Current undershoot

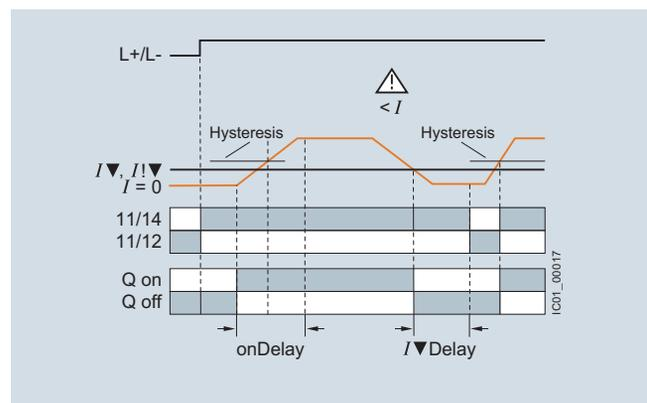

With the closed-circuit principle selected upon application of the control supply voltage

Range monitoring

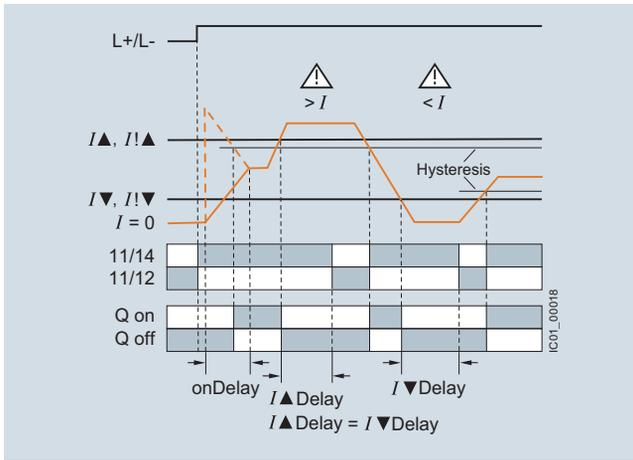

Type	3UG4822	
General technical specifications		
Rated insulation voltage U_i	V	690
Pollution degree 2 Overvoltage category III acc. to VDE 0110		
Rated impulse withstand voltage U_{imp}	kV	6
Measuring circuit		
Measuring range for single-phase AC/DC current	A	0.05 ... 15
Measuring frequency	Hz	40 ... 500
Setting range for single-phase current	A	0.05 ... 10
Load supply voltage	V	Max. 300 (with protective separation) Max. 500 (with simple separation)
Control circuit		
Load capacity of the output relay	A	5
• Thermal current I_{th}		
Rated operational current I_e at	A	3
• AC-15/24 ... 400 V		
• DC-13 at		
- 24 V	A	1
- 125 V	A	0.2
- 250 V	A	0.1
Minimum contact load at 17 V DC	mA	5

3UG48 Monitoring Relays for Stand-Alone Installation for IO-Link

Current monitoring

Selection and ordering data

- Adjustable via IO-Link and locally, with illuminated LCD
- Power supply with 24 V DC via IO-Link or external auxiliary voltage
- Adjustable converter factor to display the measured primary current when an external current transformer is used
- Auto or Manual RESET
- Open- or closed-circuit principle
- 1 CO contact, 1 semiconductor output (in SIO mode)

PU (UNIT, SET, M) = 1
 PKG* = 1 UNIT



3UG4822-1AA40



3UG4822-2AA40

Measuring range	Adjustable hysteresis	ON-delay time adjustable onDel	Tripping delay time separately adjustable /▲Del/▼Del	SD	Screw terminals 	SD	Spring-type terminals 	
A AC/DC	A	s	s	d	Article No.	Price per PU	Article No.	Price per PU
Monitoring of current for overshooting and undershooting								
0.05 ... 10	0.01 ... 5	0.1 ... 999.9	0.1 ... 999.9	2	3UG4822-1AA40	2	3UG4822-2AA40	

For accessories, see page 11/108.

For AC currents $I > 10$ A it is possible to use commercially available current transformers, e.g. the Siemens 4NC current transformer, as accessories, see [Catalog LV 10](#).

Overview



SIRIUS 3UG4841 monitoring relay

The 3UG4841 power factor and active current monitoring devices enable the load monitoring of motors.

Whereas power factor (p.f.) monitoring is used above all for monitoring no-load operation, the active current monitoring option can be used to observe and evaluate the load factor over the entire torque range.

Benefits

- Monitoring of even small single-phase motors with a no-load supply current below 0.5 A
- Simple determination of threshold values by the direct collection of measured variables on motor loading
- Range monitoring and active current measurement enable detection of cable breaks between control cabinets and motors, as well as phase failures
- Power factor and/or I_{res} (active current) can be selected as the measurement principle
- Width 22.5 mm
- Display and transmission of actual value and status messages to controller
- All versions with removable terminals
- All versions with screw or spring-type terminals

Application

- No-load monitoring and load shedding, such as in the event of a V-belt tear
- Underload monitoring in the low-end performance range, e.g. in the event of pump no-load operation
- Monitoring of overload, e.g. due to a dirty filter system
- Power factor monitoring in networks for control of compensation equipment
- Broken cable between control cabinet and motor

Technical specifications

3UG4841 monitoring relays

The 3UG4841 monitoring relays are supplied with power through IO-Link or with an external auxiliary voltage of 24 V DC and are used for performing overshoot, undershoot or range monitoring of the power factor and/or the resulting active current, depending on parameterization. The load to be monitored is connected upstream of the IN terminal. The load current flows through the terminals IN and Ly/N. The setting range for the power factor is 0 to 0.99 and for the active current I_{res} it is 0.2 to 10 A. If the control supply voltage is switched on and no load current flows, the display will show $I < 0.2$ and a symbol for overrange, under-range or range monitoring. If the motor is now switched on and the current exceeds 0.2 A, the set ON-delay time $onDel$ begins. During this time, if the set limit values are undershot or exceeded, this does not lead to a relay reaction of the changeover contact. If the operational flowing active current and/or the p.f. value falls below or exceeds the respective set threshold value, the tripping delay time begins. When this time has expired, the relay changes its switch position. The relevant measured variables for overshooting and undershooting in the display flash. If monitoring for active current undershoot is switched off ($I_{res} \nabla = OFF$), and if the load current undershoots the lower measuring range threshold (0.2 A), the CO contacts remain unchanged. If a threshold value is set for the monitoring of active current undershooting, then undershooting of the measuring range threshold (0.2 A) will result in a response of the CO contacts.

The relay operates either according to the open-circuit or closed-circuit principle.

If the device is set to Auto RESET (Memory = No), depending on the set principle of operation, the switching relay returns to its initial state and the flashing ends when the hysteresis threshold is reached.

If Manual RESET is selected in the menu (Memory = Yes), the switching relay remains in its current switching state and the current measured value and the symbol for undershooting and overshooting continues to flash, even when the measured variable reaches a permissible value again. This stored fault status can be reset by simultaneously pressing the UP▲ and DOWN▼ keys for 2.5 s.

With Manual RESET through IO-Link it is possible in addition to set whether error signals are to be deleted when the control supply voltage is switched off and on (as remote RESET) or whether the signals are to be permanently saved even in a voltage failure, with confirmation possible only through local RESET or via IO-Link.

Power factor and active current monitoring

With the closed-circuit principle selected

Response in the event of undershooting the measuring range limit with activated monitoring of I_{res} ▼

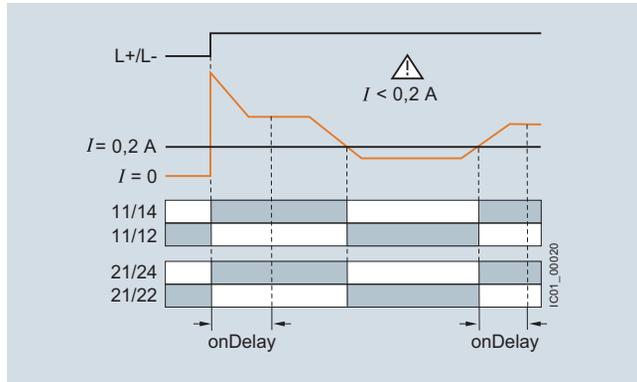

Response in the event of undershooting the measuring range limit with deactivated monitoring of active current undershooting

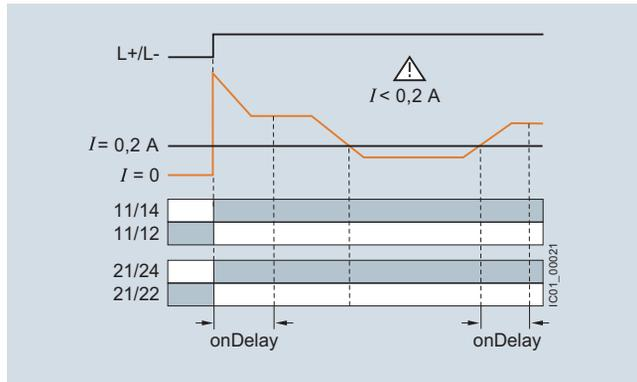

Overshooting of active current

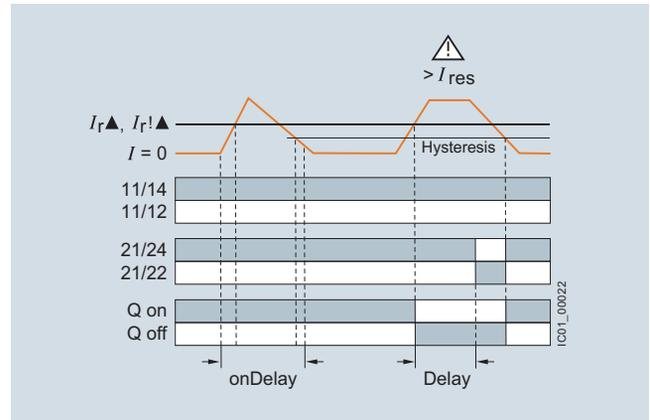

Undershooting of active current

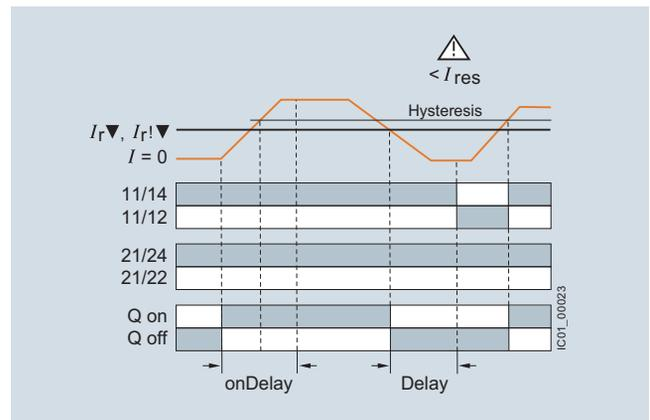

Range monitoring of active current

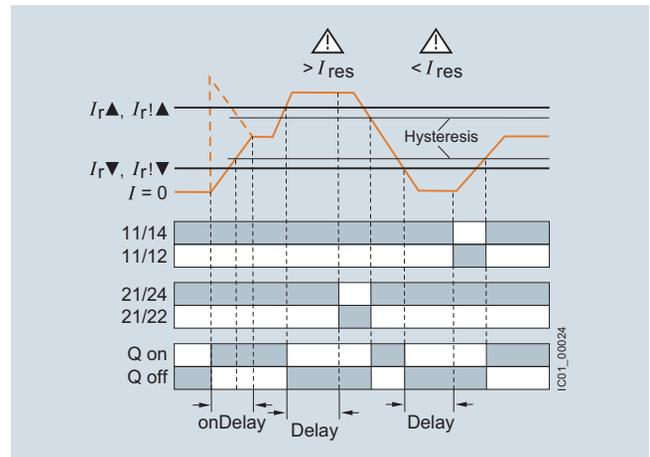

With the closed-circuit principle selected

Overshooting of power factor

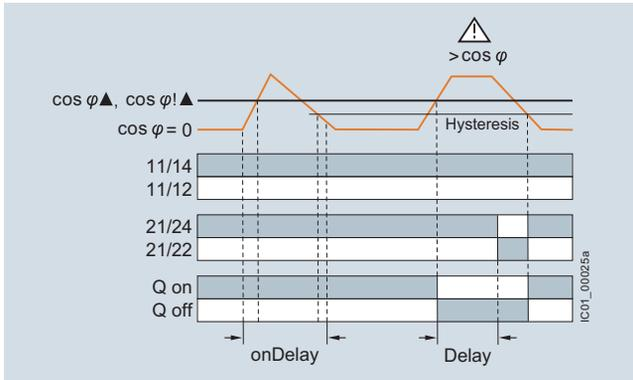

Range monitoring of power factor

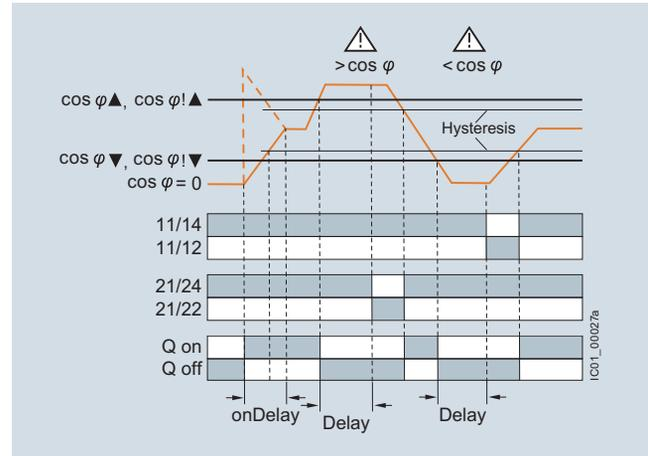

Undershooting of power factor

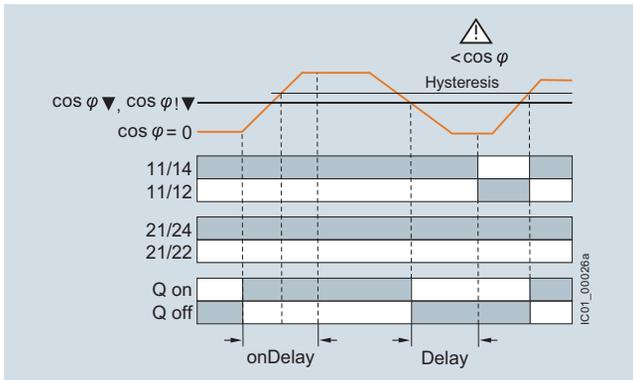

Type	3UG4841	
General technical specifications		
Rated insulation voltage U_i	V	690
Pollution degree 2 Overvoltage category III according to IEC 60664-1		
Rated impulse withstand voltage U_{imp}	kV	6
Control circuit		
Number of CO contacts for auxiliary contacts		2
Load capacity of the output relay		
• Thermal current I_{th}	A	5
Rated operational current I_e at		
• AC-15/24 ... 400 V	A	3
• DC-13 at		
- 24 V	A	1
- 125 V	A	0.2
- 250 V	A	0.1
Minimum contact load at 17 V DC	mA	5

3UG48 Monitoring Relays for Stand-Alone Installation for IO-Link

Power factor and active current monitoring

Selection and ordering data

- For monitoring the power factor and the active current I_{res} (p.f. $\times I$)
- Suitable for single- and three-phase currents
- Adjustable via IO-Link and locally, with illuminated LCD
- Power supply with 24 V DC via IO-Link or external auxiliary voltage
- Overshoot, undershoot or range monitoring adjustable
- Upper and lower limit values can be adjusted separately
- Permanent display of actual value and tripping state
- 1 CO contact each for undershoot and overshoot, 1 semiconductor output (in SIO mode)

PU (UNIT, SET, M) = 1
 PKG* = 1 UNIT



3UG4841-1CA40



3UG4841-2CA40

Measuring range		Voltage range of the measuring voltage ¹⁾ 50/60 Hz AC	Hysteresis		ON-delay time adjustable onDel	Tripping delay time separately adjustable U▲Del/ U▼Del, φ▲Del/ φ▼Del	SD	Screw terminals		SD	Spring-type terminals	
For power factor	For active current I_{res}		Adjustable for power factor	Adjustable for active current I_{res}				Article No.	Price per PU		Article No.	Price per PU
P.f.	A	V	P.f.	A	s	s	d					
Monitoring of power factor and active current for overshooting or undershooting												
0.1 ... 0.99	0.2 ... 10	90 ... 690	0.1 ... 0.2	0.1 ... 3	0 ... 999.9	0 ... 999.9	2	3UG4841-1CA40	2	3UG4841-2CA40		

¹⁾ Absolute limit values.

For accessories, see page 11/108.

For AC active currents $I_{res} > 10$ A it is possible to use commercially available current transformers, e.g. Siemens 4NC current transformers, as accessories, see Catalog LV 10.

Overview



SIRIUS 3UG4825 monitoring relay

The 3UG4825 residual-current monitoring relays are used in conjunction with the 3UL23 residual-current transformers for monitoring plants in which higher residual currents are increasingly expected due to ambient conditions. Monitoring encompasses pure AC residual currents or AC residual currents with a pulsating DC fault current component (transformer type A in accordance with DIN VDE 0100-530/IEC TR 60755).

Benefits

- High measuring accuracy of $\pm 7.5\%$
- Permanent self-monitoring
- Parameterization of the devices locally or via IO-Link possible
- Variable threshold values for warning and disconnection
- Freely configurable delay times and RESET response
- Display and transmission of actual value and status messages to controller
- High level of flexibility and space saving through installation of the transformer inside or outside the control cabinet
- Width 22.5 mm
- All versions with removable terminals
- All versions with screw or spring-type terminals

Application

Monitoring of plants in which residual currents can occur, e.g. due to dust deposits or moisture, porous cables and leads, or capacitive residual currents.

Technical specifications

3UG4825 monitoring relays

The main conductor, and any neutral conductor to which a load is connected, are routed through the opening of the annular ring core of a residual-current transformer. A secondary winding is placed around this annular strip-wound core to which the monitoring relay is connected.

If operation of a plant is fault-free, the sum of the inflowing and outward currents equals zero. No current is then induced in the secondary winding of the residual-current transformer.

However, if an insulation fault occurs downstream of the residual current operated circuit breaker, the sum of the inflowing currents is greater than that of the outward currents. The differential current – the residual current – induces a secondary current in the secondary winding of the transformer. This current is evaluated in the monitoring relay and is used on the one hand to display the actual residual current and on the other, to switch the relay if the set warning or tripping threshold is overshoot.

If the measured residual current exceeds the set warning value, the associated changeover contact instantly changes the switching state and an indication appears on the display.

If the measured residual current exceeds the set tripping value, the set delay time begins and the associated relay symbol flashes. On expiry of this time, the associated changeover contact changes the switching state.

ON-delay time for motor start

To be able to start a drive when a residual current is detected, the output relays switch to the OK state for an adjustable ON-delay time depending on the selected open-circuit principle or closed-circuit principle.

The changeover contacts do not react if the set threshold values are overshoot during this period.

With the closed-circuit principle selected

Residual current monitoring with Auto RESET (Memory = no)

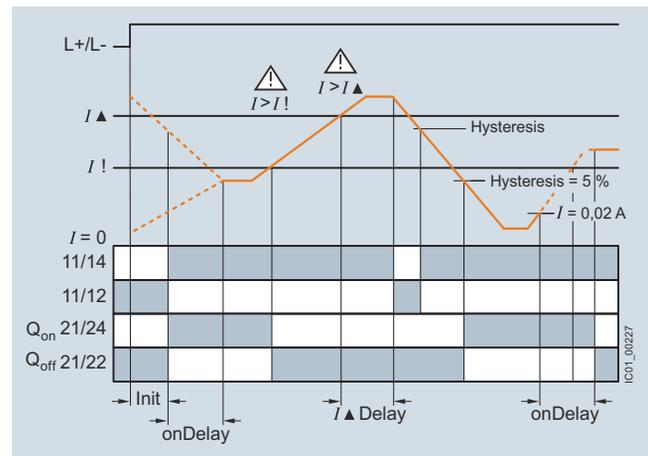

If the device is set to Auto RESET, the relay switches back to the OK state for the tripping value once the value falls below the set hysteresis threshold and the display stops flashing.

The associated relay changes its switching state if the value falls below the fixed hysteresis value of 5% of the warning value.

Any overshoots are therefore not stored.

Residual-current monitoring relays

Residual current monitoring with Manual RESET (Memory = yes)

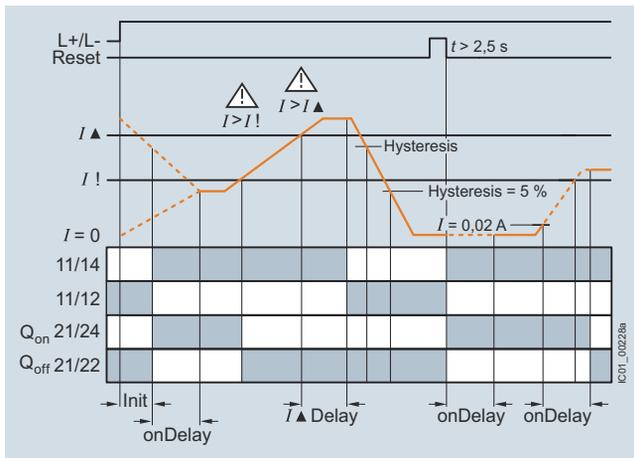

If Manual RESET is selected in the menu, the output relays remain in their current switching state and the current measured value and the symbol for overshooting continues to flash, even when the measured residual current returns to a permissible value. This stored fault status can be reset by simultaneously pressing the UP▲ and DOWN▼ keys for > 2 seconds, or by switching the supply voltage off and back on again.

Note:

The neutral conductor must not be grounded downstream of the summation current transformer as this may impair the function of the residual-current monitoring device.

Type	3UG4825-1CA40, 3UG4825-2CA40	
General data		
Insulation voltage for overvoltage category III to IEC 60664 for pollution degree 3 rated value	V	300
Impulse withstand voltage, rated value U_{imp}	kV	4
Control circuit		
Number of CO contacts for auxiliary contacts		2
Thermal current of the non-solid-state contact blocks, maximum	A	5
Current carrying capacity of the output relay		
• At AC-15 at 250 V at 50/60 Hz	A	3
• At DC-13		
- At 24 V	A	1
- At 125 V	A	0.2
- At 250 V	A	0.1
Operational current at 17 V, minimum	mA	5

Selection and ordering data

- For monitoring residual currents from 0.03 to 40 A, from 16 to 400 Hz
- For 3UL23 residual-current transformers with feed-through opening from 35 to 210 mm
- Permanent self-monitoring
- Certified in accordance with IEC 60947, functionality corresponds to IEC 62020
- Digitally adjustable, with illuminated LCD
- Permanent display of actual value and tripping state
- Separately adjustable limit value and warning threshold
- 1 changeover contact each for warning threshold and tripping threshold

PU (UNIT, SET, M) = 1
PS* = 1 unit



3UG4825-1CA40



3UG4825-2CA40

Measurable current	Adjustable response value current	Switching hysteresis	Adjustable ON-delay time	Control supply voltage At DC rated value	SD	Screw terminals 	SD	Spring-type terminals 	
A	A	%	s	V	d	Article No.	Price per PU	Article No.	Price per PU
0.01 ... 43	0.03 ... 40	0 ... 50	0 ... 999.9	24	2	3UG4825-1CA40		3UG4825-2CA40	

For accessories, see page 11/108.

For 3UL23 residual-current transformers and accessories for 3UL23, see page 11/71.

Overview

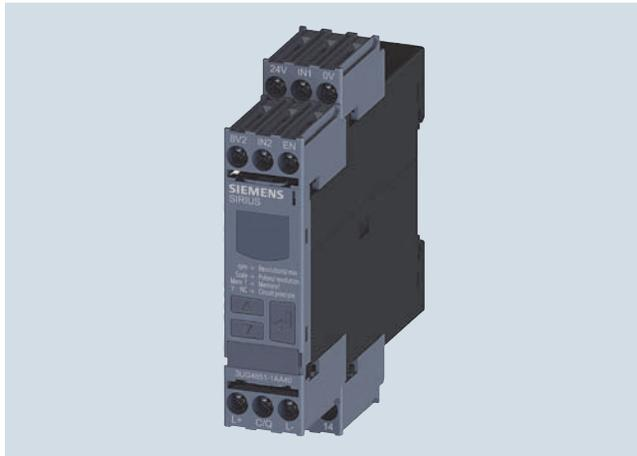

SIRIUS 3UG4851 monitoring relay

3UG4851 monitoring relays are used in combination with a sensor to monitor drives for overspeed and/or underspeed.

Furthermore, the monitoring relays are ideal for all functions where a continuous pulse signal needs to be monitored (e.g. belt travel monitoring, completeness monitoring, passing monitoring, clock-time monitoring).

Benefits

- Variably adjustable to overshoot, undershoot or range monitoring
- Freely configurable delay times and RESET response
- Display and transmission of actual value and fault type to controller
- Use of up to 10 sensors per rotation for extremely slowly rotating motors
- 2- or 3-wire sensors and sensors with a mechanical switching output or semiconductor output can be connected
- Auxiliary voltage for sensor integrated
- All versions with removable terminals
- All versions with screw or spring-type terminals

Application

- Slip or tear of a belt drive
- Overload monitoring
- Transport monitoring for completeness

Technical specifications

3UG4851 monitoring relays

The speed monitoring relay operates according to the principle of period duration measurement.

In the monitoring relay, the time between two successive rising edges of the pulse encoder is measured and compared to the minimum and/or maximum permissible period duration calculated from the set limit values for the speed.

Thus, the period duration measurement recognizes any deviation in speed after just two pulses, even at very low speeds or in the case of extended pulse gaps.

By using up to ten pulse encoders evenly distributed around the circumference, it is possible to shorten the period duration, and in turn the response time. By taking into account the number of sensors in the monitoring relay, the speed continues to be indicated in rpm.

ON-delay time for motor start

To be able to start a motor drive, and depending on whether the open-circuit or closed-circuit principle is selected, the output relay switches to the GO state during the ON-delay time, even if the speed is still below the set value.

The ON-delay time is started by either switching on the auxiliary voltage or, if the auxiliary voltage is already applied, by actuating the respective NC contact (e.g. auxiliary contact).

Speed monitoring with Auto RESET (Memory = no)

If the device is set to Auto RESET, the output relay switches to the GO state, once the adjustable hysteresis threshold is reached in the range of 1 to 99.9 rpm and the flashing stops. Any overshoots or undershoots are therefore not stored.

Speed monitoring with Manual RESET (Memory = yes)

If Manual RESET is selected in the menu, the output relay remains in its current switching state and the current measured value and the symbol for overshooting/undershooting continue to flash, even when the speed returns to a permissible value. This stored fault status can be reset by simultaneously pressing the UP▲ and DOWN▼ keys for > 2.5 s or by connecting the RESET device terminal to 24 V DC.

With Manual RESET through IO-Link it is possible in addition to set whether error signals are to be deleted when the control supply voltage is switched off and on (as remote RESET) or whether the signals are to be permanently saved even in a voltage failure, with confirmation possible only through local RESET or via IO-Link.

Speed monitoring

With the closed-circuit principle selected

Range monitoring without enable input

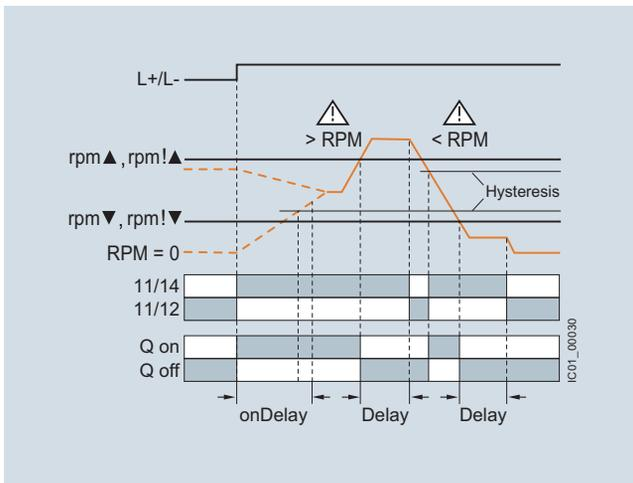

Range monitoring with enable input

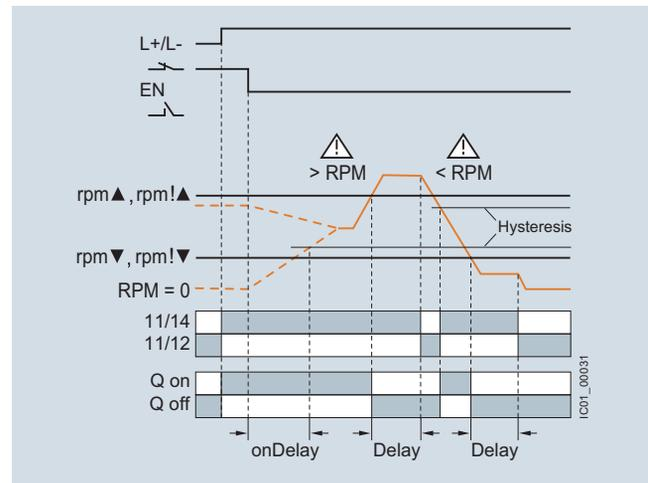

Type	3UG4851	
General technical specifications		
Rated insulation voltage U_i	V	300
Pollution degree 2 Overvoltage category III acc. to VDE 0110		
Rated impulse withstand voltage U_{imp}	kV	4
Measuring circuit		
Sensor supply		
• For 3-wire sensor (24 V/0 V)	mA	Max. 50
• For 2-wire NAMUR sensor (8V2)	mA	Max. 8.2
Signal input		
• IN1	k Ω	16, 3-wire sensor, pnp operation
• IN2	k Ω	1, floating contact, 2-wire NAMUR sensor
Voltage level		
• For level 1 at IN1	V	4.5 ... 30
• For level 0 at IN1	V	0 ... 1
Current level		
• For level 1 at IN2	mA	> 2.1
• For level 0 at IN2	mA	< 1.2
Minimum pulse duration of signal	ms	5
Minimum interval between 2 pulses	ms	5
Control circuit		
Number of CO contacts for auxiliary contacts		1
Load capacity of the output relay		
Thermal current I_{th}	A	5
Rated operational current I_o at		
• AC-15/24 ... 250 V	A	3
• DC-13 at		
- 24 V	A	1
- 125 V	A	0.2
- 250 V	A	0.1
Minimum contact load at 17 V DC	mA	5

3UG48 Monitoring Relays for Stand-Alone Installation for IO-Link

Speed monitoring

Selection and ordering data

- For speed monitoring in revolutions per minute (rpm)
- Two- or three-wire sensor with mechanical or electronic switching output can be connected
- Two-wire NAMUR sensor can be connected
- Sensor supply 24 V DC/50 mA integrated
- Input frequency 0.1 to 2 200 pulses per minute (0.0017 to 36.7 Hz)
- With or without enable signal for the drive to be monitored
- Adjustable via IO-Link and locally, with illuminated LCD
- Power supply with 24 V DC via IO-Link or external auxiliary voltage
- Overshoot, undershoot or range monitoring adjustable
- Number of pulses per revolution can be adjusted
- Upper and lower limit values can be adjusted separately
- Auto, manual or remote RESET options after tripping
- Permanent display of actual value and tripping state
- 1 CO contact, 1 semiconductor output (in SIO mode)

PU (UNIT, SET, M) = 1
 PKG* = 1 UNIT



3UG4851-1AA40



3UG4851-2AA40

Measuring range	Adjustable hysteresis	ON-delay time adjustable onDel	Tripping delay time separately adjustable rpm▲Del/rpm▼Del	Pulses per revolution	SD	Screw terminals 	SD	Spring-type terminals 		
rpm	rpm	s	s		d	Article No.	Price per PU	d	Article No.	Price per PU
Speed monitoring for overshooting and undershooting										
0.1 ... 2 200	OFF 1 ... 99.9	0 ... 999.9	0 ... 999.9	1 ... 10	2	3UG4851-1AA40	2	3UG4851-2AA40		

For accessories, see page 11/108.

Selection and ordering data

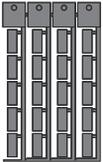
	Use	Version	SD	Article No.	Price per PU	PU (UNIT, SET, M)	PS*
Blank labels							
 <p>3RT2900-1SB20</p>	For 3UG48	Unit labeling plates For SIRIUS devices 20 mm x 7 mm, titanium gray	20	3RT2900-1SB20		100	340 units
	For 3UG48	Adhesive labels for SIRIUS devices <ul style="list-style-type: none"> • 19 mm x 6 mm, pastel turquoise • 19 mm x 6 mm, zinc yellow 	15	3RT1900-1SB60		100	3 060 units
			15	3RT1900-1SD60		100	3 060 units
Push-in lugs and covers							
 <p>3RP1903</p> <p>3RP1902</p>	For 3UG48	Push-in lugs For screw fixing, 2 units are required for each device	5	3RP1903		1	10 units
	For 3UG48	Sealable covers For securing against unauthorized adjustment of setting knobs	5	3RP1902		1	5 units
Tools for opening spring-type terminals							
 <p>3RA2908-1A</p>	For auxiliary circuit connections	Screwdrivers For all SIRIUS devices with spring-type terminals 3.0 mm x 0.5 mm, length approx. 200 mm, titanium gray/black, partially insulated	2	Spring-type terminals 		1	1 unit
				3RA2908-1A			

Overview



SIRIUS 3UG546 DC load monitoring relays

More information

Homepage, see www.usa.siemens.com/relays

Industry Mall, see <https://mall.industry.siemens.com/mall/en/WWW/Catalog/Products/10355238?tree=CatalogTree>

The SIRIUS 3UG546 DC load monitoring relays are suitable for monitoring motors, batteries, and other DC equipment. The devices monitor the DC current, voltage, and actual power for overshooting or undershooting of set limit values in one or two channels. The relays have a CO contact output for alarms and operate on the closed-circuit principle (NC).

The devices are parameterized via PROFINET, and transfer the measured values and diagnostic messages to a controller. Besides providing detailed fault diagnostics, the integrated energy counters, operating hours counters, and operating cycle counters can also be read out and reset.

When metering energy consumption, the SIRIUS 3UG546 DC load monitoring relays distinguish the direction of current flow and can thus, for example, separately sense the quantities of energy stored in or drawn from a battery.

Features	3UG5461-1AA40, 3UG5462-1AA40
DC monitoring	
Monitoring the DC current for undershoot	✓
Monitoring the DC current for overshoot	✓
Range monitoring	✓
Voltage monitoring	
Monitoring the voltage for undershoot	✓
Monitoring the voltage for overshoot	✓
Range monitoring	✓
Power monitoring	
Monitoring the power for undershoot	✓
Monitoring the power for overshoot	✓
Range monitoring	✓
Delay times	
ON-delay	✓
Tripping delay	✓
Operating hours counter	
Monitoring for overshoot	✓
Operating cycles counter	
Monitoring for overshoot	✓
Energy recovery counter	
Monitoring for overshoot	✓
Energy consumption counter	
Monitoring for overshoot	✓
PROFINET IO functions	
Ethernet services	✓
Port diagnostics	✓
Min. update time	2 ms
Resetting of communication parameters to factory settings	✓
PROFINET RT (real-time communication)	✓
Firmware update via PROFINET IO	✓
I&M identification data 0 to 3	✓

✓ Available

Article No. scheme

Product versions	Article number
Monitoring relays	3UG546 □ - 1 A A 4 0
Current measuring range	1
2 x 8 A/1 x 16 A	2
1 x 63 A	
Example	3UG546 1 - 1 A A 4 0

Note:

The Article No. scheme shows an overview of product versions for better understanding of the logic behind the article numbers.

For your orders, please use the article numbers quoted in the selection and ordering data.

Benefits

- Wide voltage measuring range of up to 800 V
- Detection and monitoring of current, voltage and power in a single device
- Detailed fault diagnostics
- Energy metering with distinction of direction of current flow
- Communication and visualization via PROFINET and thus quick and easy integration for visualizing plant energy values
- Integration in the TIA Portal
- Customary screw terminals for quick and reliable wiring
- Device replacement without renewed wiring thanks to removable terminals

Application

- Exhaustive discharge protection on battery-operated vehicles
- Acquisition of energy flows, incl. energy recovery, e.g. for robots
- DC line monitoring
- DC heaters
- Lighting systems
- Energy management
- Condition monitoring

Technical specifications

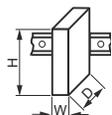
More information			
Technical specifications, see https://support.industry.siemens.com/cs/ww/en/ps/25412/td		Equipment Manual, see https://support.industry.siemens.com/cs/ww/en/ps/25412/man FAQs, see https://support.industry.siemens.com/cs/ww/en/ps/25412/faq	
Article number		3UG5461-1AA40	3UG5462-1AA40
General technical specifications:			
Width x height x depth	mm	22.5 × 100 × 141.6	45 × 100 × 141.6
			
Type of electrical separation		Protective separation	
Electrical endurance (operating cycles) for relay outputs, maximum		100 000, 0.5 A, 125 V AC, for resistive load up to 40 °C	
Mechanical endurance (operating cycles), typical		10 000 000	
Power loss, maximum	W	3	
Adjustable response value current 1	A	-8 ... +8	-63 ... +63
Adjustable response value current 2	A	-8 ... +8	--
Adjustable ON-delay time			
• On starting	s	0 ... 999	
• On upper or lower limit violation	s	0 ... 999	
Adjustable voltage range	V	0 ... +800	
Minimum supply voltage failure buffering time	ms	10	
Reaction time, maximum	ms	100	
Degree of protection		IP20	--
• On front		--	IP20
• Of the terminal		--	IP20
Type of mounting		Any	
• Mounting position		Any	
Installation altitude at height above sea level, maximum	m	2 000	
Ambient temperature			
• During operation	°C	-25 ... +60	
• During storage	°C	-40 ... +80	
Relative temperature-related measurement deviation	%	0.5	
Number of ports at the interface 1		1	
Product function			
• Operating cycles counter		Yes	
• Operating hours counter		Yes	
• Removable terminal for main circuit		Yes	
• Removable terminal for auxiliary and control circuit		Yes	No
• Auto RESET		Yes	
• Manual RESET		Yes	
• Overvoltage detection DC		Yes	
• Overcurrent detection DC		Yes	
• Undervoltage detection DC		Yes	
• Undercurrent detection DC		Yes	

SIRIUS 3UG546 DC Load Monitoring Relays

DC load monitoring **NEW**

Article number	3UG5461-1AA40	3UG5462-1AA40
Measuring circuit:		
Relative measuring accuracy		
• Relative to the measured value	%	2
• Relative to the full-scale value	%	2
Number of CO contacts for auxiliary contacts		1
Control circuit:		
Current-carrying capacity of the output relay		
• At DC-13 at 24 V	A	1
Thermal current of the non-solid-state contact blocks, maximum	A	1
Type of voltage for monitoring		DC
Type of current for monitoring		DC
Supply voltage type		DC
Supply voltage 1 at DC, rated value	V	24
Supply voltage:		
Operating range factor of the control supply voltage, rated value		
• At DC		0.85 ... 1.15

Article number	3UG5461-1AA40	3UG5462-1AA40
Type of electrical connection	 Screw terminals	
Connectable conductor cross-section for auxiliary contacts		
• Solid	mm ²	1 x (0.5 ... 4), 2 x (0.5 ... 2.5)
• Finely stranded with end sleeve	mm ²	1 x (0.5 ... 4), 2 x (0.5 ... 1.5)
• For AWG cables		1 x (20 ... 12), 2 x (20 ... 14)
Connectable conductor cross-section for main contacts		
• Solid	mm ²	1 x (0.5 ... 4), 2 x (0.5 ... 2.5)
• Finely stranded with end sleeve	mm ²	1 x (0.5 ... 4), 2 x (0.5 ... 2.5)
• Stranded	mm ²	1 x (0.5 ... 4), 2 x (0.5 ... 2.5)
• For AWG cables		1 x (20 ... 12), 2 x (20 ... 14)
		2 x (1 ... 16), 1 x (1 ... 16)
		2 x (1 ... 25), 1 x (1 ... 35)
		2 x (1 ... 16), 1 x (1 ... 16)
		1 x (18 ... 1), 2 x (18 ... 2)

The SIRIUS 3UG546 DC load monitoring relays monitor a DC load current circuit for undershooting or overshooting of set limit values in one or two channels. Current, voltage, and power can be monitored separately. When the relays measure the current, they also detect the direction of current and have separate counters for measuring energy consumption and energy recovery.

The devices count the operating cycles and the operating hours of the connected loads as well as the operating cycles of the internal relay. All counters can be monitored for settable limit values and the counter statuses can be reset (with the exception of the operating cycle counter of the internal relay).

The SIRIUS 3UG546 DC load monitoring relays are parameterized exclusively via a PROFINET interface. All measured values and counter values as well as other diagnostics data are transmitted to a controller via PROFINET. The relays can also be operated without PROFINET. If communication fails, the monitoring function continues to be reliably executed. The internal relay, which is switched as a signaling output that responds when a set limit value is undershot or overshoot, responds to detected system faults.

All monitored counter values and measured values can be additionally assigned a warning limit, which generates an alarm via PROFINET when the set value is undershot or overshoot. Violations of the set limit values are also signaled as an alarm via PROFINET.

The devices are supplied via an external 24 V DC voltage source.

The integral counters for operating hours and operating cycles support operators in requirement-oriented plant maintenance. The operating hours counter outputs the time during which a measurable current flows. The properties of the insulation material of the motor windings, for example, deteriorate during operation due to the thermal load. The operating hours serve as an indicator of upcoming maintenance or replacement of machine parts and system components.

The operating cycles counter is incremented by one each time a breaking operation of the monitored load is detected (transition from current flow to no measurable current flow). The number of operating cycles serves as an indicator of upcoming maintenance or replacement of contact blocks. Arcs in breaking operations cause high loads and wear in particular in DC current circuits.

SIRIUS 3UG546 DC Load Monitoring Relays

DC load monitoring **NEW**

With the closed-circuit principle selected upon application of the control supply voltage

Monitoring for overshooting and undershooting of a measured value including parameterized warning limit/current flow in one direction only/Automatic RESET

Monitoring for overshooting of a measured value including parameterized warning limit/Manual RESET

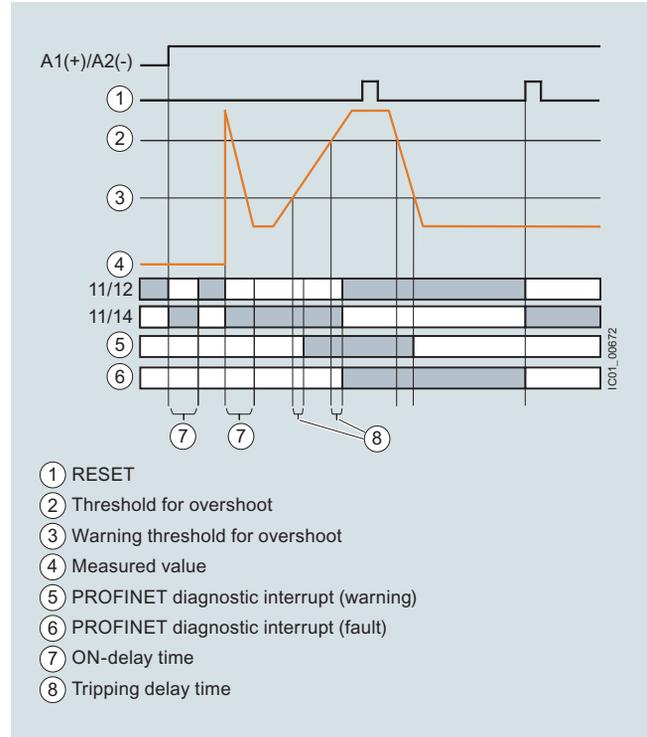
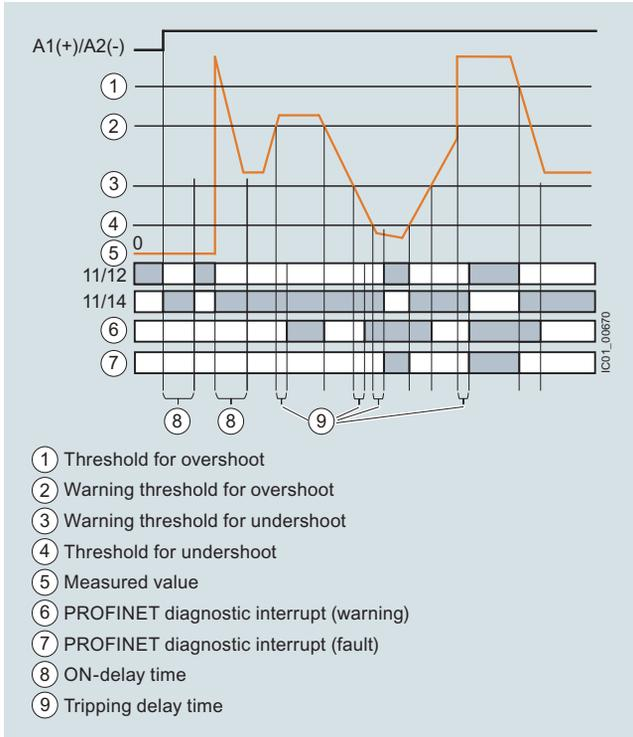

Monitoring for overshooting and undershooting of a measured value including parameterized warning limit/current flow in both directions (energy consumption and energy recovery)/ Automatic RESET

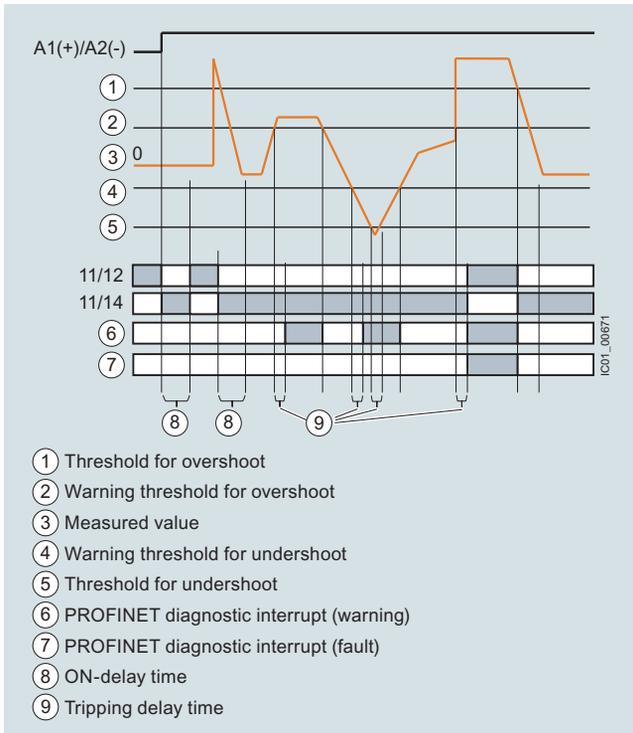

Selection and ordering data



3UG5461-1AA40



3UG5462-1AA40

Current measuring range	Width	SD	Screw terminals	Price per PU	PU (UNIT, SET, M)	PS*
A	mm	d	Article No.			
DC load monitoring						
2 x 8/1 x 16	22.5	20	3UG5461-1AA40		1	1 unit
1 x 63	45	20	3UG5462-1AA40		1	1 unit

Accessories

Version	SD	Article No.	Price per PU	PU (UNIT, SET, M)	PS*
	d				

Terminals for SIRIUS devices in the industrial standard mounting rail enclosure



3ZY1122-1BA00

Removable terminals

- 2-pole, up to 1 x 4 mm² or 2 x 2.5 mm²

Screw terminals

2	3ZY1122-1BA00	1	6 units
---	----------------------	---	---------

Accessories for enclosures



3ZY1311-0AA00

Push-in lugs

For wall mounting

3ZY1311-0AA00

2		1	10 units
---	--	---	----------



3ZY1440-1AA00

Coding pins

For removable terminals of SIRIUS devices in the industrial standard mounting rail enclosure; enable the mechanical coding of terminals

3ZY1440-1AA00

2		1	12 units
---	--	---	----------



3ZY1450-1AB00

Hinged cover

Replacement cover, without terminal labeling, titanium gray

- 22.5 mm wide

3ZY1450-1AB00

2		1	5 units
---	--	---	---------

Overview



SIRIUS 3RQ3 coupling relays

SIRIUS 3RQ3 coupling relays in narrow design are used for coupling control signals from and to a controller, and they are available in different versions:

- Coupling relays with relay output (not plug-in)
- Coupling relays with plug-in relays
- Coupling relays with semiconductor output (not plug-in)

Coupling relays with relay output (not plug-in)

AC and DC operation

IEC/EN 60947-5-1

The input and output coupling relays differ with regard to the positioning of the terminals and the LEDs.

Coupling relays with plug-in relays

AC and DC operation

IEC 60947-1

The coupling relays are plug-in, so the relay can be replaced quickly at the end of its service life without detaching the wiring.

Coupling relays with semiconductor output (not plug-in)

AC and DC operation

IEC 60947-1, EN 60664-1 and EN 50005;
coupling relays with semiconductor output: EN 60747-5;
programmable controllers: IEC 61131-2

The input and output coupling relays differ with regard to the positioning of the terminals and the LEDs.

The coupling relays with semiconductor output have extremely high contact reliability, so they are especially suitable for electronic systems.

For test purposes, versions are available with manual-0-automatic switches.

Article No. scheme

Product versions		Article number	
Coupling relays with relay output (not plug-in)		3RQ30 □ 8 – □ A □ 0 □	
Design and type of output	Output coupler, without manual/automatic switch	1	
	Input coupler	3	
Type of electrical connection	Screw terminals	1	
	Spring-type terminals (push-in)	2	
Control supply voltage	24 V AC/DC		B
	115 V AC/DC		E
	230 V AC/DC		F
Material of switching contacts	e.g.		
	0 = AgSnO2		□
	1 = AgSnO2 hard gold-plated		□
Example		3RQ30 1 8 – 1 A B 0 1	

Product versions		Article number	
Coupling relays with relay output (not plug-in)		3RQ30 1 8 – 2 A □ 0 8 – 0 A A 0	
Railway version with extended operating range 0.7 ... 1.2 x U _s			
Control supply voltage	24 V DC		M
	110 V DC		N
Example		3RQ30 1 8 – 2 A M 0 8 – 0 A A 0	

Product versions		Article number	
Coupling relays with plug-in relays		3RQ31 1 8 – □ A □ 0 □	
Type of electrical connection	Screw terminals	1	
	Spring-type terminals (push-in)	2	
Control supply voltage	24 V AC/DC		B
	115 V AC/DC		E
	230 V AC/DC		F
	24 V DC		M
Material of switching contacts	AgSnO2		0
	AgSnO2 hard gold-plated		1
Example		3RQ31 1 8 – 1 A B 0 1	

Product versions		Article number		Control supply voltage	Switching voltage of the semiconductor output	
Coupling relays with semiconductor output (not plug-in)		3RQ30 □ □ – □ S □ □ 0				
	Current carrying capacity of the semiconductor output					
Output coupler	• Without manual/automatic switch	1 mA ... 0.5 A	3RQ30 5 0 – □ S M 5 0	11 ... 30 V DC	10 ... 60 V DC	
		5 mA ... 2 A	3RQ30 5 2 – □ S M 3 0	11 ... 30 V DC	10 ... 30 V DC	
		1 mA ... 2 A	3RQ30 5 2 – □ S M 4 0	11 ... 30 V DC	10 ... 60 V DC	
		5 mA ... 2 A	3RQ30 5 2 – □ S M 5 0	11 ... 30 V DC	20 ... 264 V AC	
		1 mA ... 3 A	3RQ30 5 3 – □ S G 3 0	110 ... 230 V AC/DC	10 ... 30 V DC	
	• With manual/automatic switch	5 mA ... 5 A	3RQ30 5 5 – □ S M 3 0	11 ... 30 V DC	10 ... 30 V DC	
		5 mA ... 5 A	3RQ30 6 5 – □ S M 3 0	11 ... 30 V DC	10 ... 30 V DC	
		Input coupler	10 mA ... 0.5 A	3RQ30 7 0 – □ S B 3 0	11 ... 30 V AC/DC	10 ... 30 V DC
				3RQ30 7 0 – □ S G 3 0	110 ... 230 V AC/DC	10 ... 30 V DC
		Type of electrical connection	Screw terminals	1		
Spring-type terminals (push-in)	2					
Example		3RQ30 7 0 – 1 S B 3 0				

Note:

These Article No. schemes show an overview of product versions for better understanding of the logic behind the article numbers.

For your orders, please use the article numbers quoted in the selection and ordering data.

Benefits**General**

- All versions with screw terminals or spring-type terminals (push-in technology)
- TOP wiring with spring-type terminals (push-in) for quick and reliable wiring
- Low space requirements in the control cabinet thanks to a consistent width of 6.2 mm
- Reduced inventory due to fewer variants
- Clearly visible functional state of the coupling relay by green LED
- Integrated reverse polarity protection and EMC arc-suppression diode
- Standardized accessories across the entire 3RQ3 series
- Universal bridging option using connecting combs for all terminals
- Galvanic isolation plate for isolating different voltages for neighboring units
- Clip-on labels available as set for individual labeling

Coupling relays with relay output (not plug-in)

- Relays fixed in enclosure for increased contact reliability
- Device variants with hard gold-plated contacts, hence high contact reliability at low currents

Coupling relays with plug-in relays

- Fast replacement of the relays with existing wiring
- Shorter installation times thanks to certified complete units
- Individual relays available as spare parts
- Device variants with hard gold-plated contacts, hence high contact reliability at low currents

Coupling relays with semiconductor output (not plug-in)

- Long service life since there is no mechanical wear
- High switching frequency thanks to short make-break times
- Vibration-resistant
- No contact bounce
- Extremely high contact reliability
- Noise-free switching
- Low control power required
- Switching of DC and capacitive loads

Application

- Electrical separation between the input and output circuit
- Adjustment of different signal levels
- Signal amplification

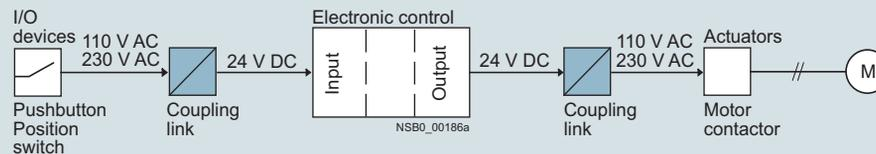

Application example motor controller

Technical specifications

More information

Technical specifications, see
<https://support.industry.siemens.com/cs/ww/en/ps/16198/td>
 FAQs, see <https://support.industry.siemens.com/cs/ww/en/ps/16198/faq>

Operating instructions, see
<https://support.industry.siemens.com/cs/ww/en/ps/16198/man>

Coupling relays with relay output (not plug-in)

Article number	3RQ30.8- .AB00	3RQ30.8- .AB01	3RQ30.8- .AE00	3RQ30.8- .AE01	3RQ30.8- .AF00	3RQ30.8- .AF01	3RQ3018- 2AM08-0AA0	3RQ3018- 2AN08-0AA0
----------------	-------------------	-------------------	-------------------	-------------------	-------------------	-------------------	------------------------	------------------------

General technical specifications

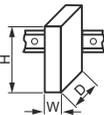
Width x height x depth		mm	6.2 x 93 x 72.5					
Insulation voltage for overvoltage category III acc. to IEC 60664 for pollution degree 3	V	300						
Max. permissible voltage for protective separation between control circuit and auxiliary circuit	V	300						
Ambient temperature								
• During operation	°C	-25 ... +60		-40 ... +70				
• During storage	°C	-40 ... +85						
Degree of protection	IP20							
Version of the fuse link required for short-circuit protection of the auxiliary switch	Fuse gG: 4 A							
Operational current of the auxiliary contacts								
• At AC-15								
- At 24 V	A	3						
- At 250 V	A	3						
• At DC-13								
- At 24 V	A	1						
- At 125 V	A	0.2						
- At 250 V	A	0.1						
Contact reliability of the auxiliary contacts (one contact failure per 100 million)		17 V, 5 mA	5 V, 1 mA	17 V, 5 mA	5 V, 1 mA	17 V, 5 mA	5 V, 1 mA	17 V, 5 mA
Mechanical endurance (operating cycles) typical	10 000 000							
Electrical endurance (operating cycles) for AC-15 at 230 V typical	100 000							
Operating range factor of the control supply voltage, rated value								
• At AC								
- At 50 Hz		0.8 ... 1.25		0.8 ... 1.1			--	
- At 60 Hz		0.8 ... 1.25		0.8 ... 1.1			--	
• At DC		0.8 ... 1.25		0.8 ... 1.1			0.7 ... 1.25	
Active power input	W	0.3	0.5	1			0.3	0.6
Thermal current	A	6						

Coupling Relays

Coupling Relays – Narrow Design

3RQ3

Coupling relays with plug-in relay

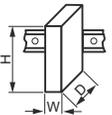
Article number	3RQ3118-.AB00	3RQ3118-.AB01	3RQ3118-.AE00	3RQ3118-.AE01	3RQ3118-.AF00	3RQ3118-.AF01	3RQ3118-.AM00	3RQ3118-.AM01	
General technical specifications									
Width x height x depth			mm	6.2 x 93 x 76					
Insulation voltage for overvoltage category III acc. to IEC 60664 for pollution degree 3	V	300							
Max. permissible voltage for protective separation between control circuit and auxiliary circuit	V	300							
Ambient temperature									
• During operation	°C	-25 ... +60							
• During storage	°C	-40 ... +85							
Degree of protection	IP20								
Version of the fuse link required for short-circuit protection of the auxiliary switch	Fuse gG: 4 A								
Operational current of the auxiliary contacts									
• At AC-15									
- At 24 V	A	3							
- At 250 V	A	3							
• At DC-13									
- At 24 V	A	1							
- At 125 V	A	0.2							
- At 250 V	A	0.1							
Contact reliability of the auxiliary contacts (one contact failure per 100 million)		17 V, 5 mA	5 V, 1 mA	17 V, 5 mA	5 V, 1 mA	17 V, 5 mA	5 V, 1 mA	17 V, 5 mA	5 V, 1 mA
Mechanical endurance (operating cycles) typical	10 000 000								
Electrical endurance (operating cycles) for AC-15 at 230 V typical	100 000								
Operating range factor of the control supply voltage, rated value									
• At AC									
- At 50 Hz		0.8 ... 1.25		0.8 ... 1.1				--	
- At 60 Hz		0.8 ... 1.25		0.8 ... 1.1				--	
• At DC		0.8 ... 1.25		0.8 ... 1.1			0.8 ... 1.25		
Active power input	W	0.3		0.5		1		0.3	
Thermal current	A	6							

Coupling relays with semiconductor output (not plug-in)

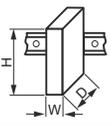
Article number	3RQ3050- .SM50	3RQ3052- .SM30	3RQ3052- .SM40	3RQ3052- .SM50	3RQ3053- .SG30	3RQ3055- .SM30	3RQ3065- .SM30	3RQ3070- .SB30	3RQ3070- .SG30	
General technical specifications										
Width x height x depth	mm 6.2 x 93 x 72.5						6.2 x 93 x 75		6.2 x 93 x 72.5	
										
Insulation voltage for overvoltage category III acc. to IEC 60664 for pollution degree 3	V	50			300		50		--	
Ambient temperature										
• During operation	°C	-25 ... +60								
• During storage	°C	-40 ... +85								
Degree of protection		IP20								
Switching voltage of the semiconductor output										
• At AC	V	--	20 ... 264			--				
• At DC	V	10 ... 60	10 ... 30	10 ... 60	--	10 ... 30				
Current carrying capacity of the semiconductor output										
• At AC		--	5 mA ... 2 A			--				
• At DC		1 mA ... 0.5 A	5 mA ... 2 A	1 mA ... 2 A	--	1 mA ... 3 A	5 mA ... 5 A	10 mA ... 0.5 A		
Operating range factor of the control supply voltage, rated value										
• At AC										
- At 50 Hz		--	1 ... 1			--	1 ... 1			
- At 60 Hz		--	1 ... 1			--	1 ... 1			
• At DC		1 ... 1								
Active power input	W	0.3	0.25		0.3	0.5				
Thermal current	A	0.5	2	3		5	0.5			
Article number	3RQ3...-1....					3RQ3...-2....				
Type of electrical connection for auxiliary and control circuits	 Screw terminals					 Spring-type terminals (push-in)				
Type of connectable conductor cross-sections										
• Solid	1x (0.25 ... 2.5) mm ²									
• Finely stranded										
- Without end sleeves	--					1x (0.25 ... 2.5) mm ²				
- With end sleeves	1x (0.25 ... 1.5) mm ²									
• Solid for AWG cables	1x (20 ... 14)									

Selection and ordering data

Type of voltage	Control supply voltage			Number of CO contacts for auxiliary contacts	Material of switching contacts	SD	Article No.	Price per PU	PU (UNIT, SET, M)	PS*
	At AC		At DC							
	At 50 Hz	At 60 Hz	V							

Coupling relays with relay output (not plug-in)

Output coupling links

AC/DC	24	24	24	1	AgSnO2	2	3RQ3018-□AB00		1	5 units
					AgSnO2 hard gold-plated	2	3RQ3018-□AB01			
	115	115	115	1	AgSnO2	2	3RQ3018-□AE00		1	5 units
	230	230	230	1	AgSnO2	2	3RQ3018-□AF00		1	5 units
DC	--	--	24	1	AgSnO2	2	3RQ3018-2AM08-0AA0		1	5 units
			110	1	AgSnO2	2	3RQ3018-2AN08-0AA0		1	5 units

Input coupling links

AC/DC	24	24	24	1	AgSnO2	2	3RQ3038-□AB00		1	5 units
					AgSnO2 hard gold-plated	2	3RQ3038-□AB01			
	115	115	115	1	AgSnO2	2	3RQ3038-□AE00		1	5 units
	230	230	230	1	AgSnO2	2	3RQ3038-□AF00		1	5 units
DC	--	--	24	1	AgSnO2	2	3RQ3038-□AM00		1	5 units
			110	1	AgSnO2 hard gold-plated	2	3RQ3038-□AF01		1	5 units

Coupling relays with plug-in relay

Output coupling links

AC/DC	24	24	24	1	AgSnO2	2	3RQ3118-□AB00		1	5 units
					AgSnO2 hard gold-plated	2	3RQ3118-□AB01			
	115	115	115	1	AgSnO2	2	3RQ3118-□AE00		1	5 units
	230	230	230	1	AgSnO2	2	3RQ3118-□AF00		1	5 units
DC	--	--	24	1	AgSnO2	2	3RQ3118-□AM00		1	5 units
			110	1	AgSnO2 hard gold-plated	2	3RQ3118-□AM01		1	5 units

3RQ3018-2....
3RQ3038-2....
3RQ3118-2....

Type of electrical connection

- Screw terminals
- Spring-type terminals (push-in)

1

2

Type of voltage	Control supply voltage			Current carrying capacity of the semiconductor output		Operating mode selectable via switch position	SD	Article No.	Price per PU	PU (UNIT, SET, M)	PS*
	At AC		At DC	At AC	At DC						
	At 50 Hz	At 60 Hz	V	A	A						

Coupling relays with semiconductor output (not plug-in)

Output coupling links

DC	--	--	11 ... 30 V	--	1 mA ... 0.5 A	--	2	3RQ3050-□SM50		1	5 units
					5 mA ... 2 A	--	2	3RQ3052-□SM30			
					1 mA ... 2 A	--	2	3RQ3052-□SM40			
					5 mA ... 2 A	--	2	3RQ3052-□SM50			
					5 mA ... 5 A	--	2	3RQ3055-□SM30			
					Manual/Off/Automatic	--	2	3RQ3065-□SM30			
AC/DC	110 ... 230 V	110 ... 230 V	110 ... 230 V	--	1 mA ... 3 A	--	2	3RQ3053-□SG30		1	5 units

Input coupling links

AC/DC	11 ... 30 V	11 ... 30 V	11 ... 30 V	--	10 mA ... 0.5 A	--	2	3RQ3070-□SB30		1	5 units
	110 ... 230 V	110 ... 230 V	110 ... 230 V	--	10 mA ... 0.5 A	--	2	3RQ3070-□SG30		1	5 units

Type of electrical connection

- Screw terminals
- Spring-type terminals (push-in)

1

2

Accessories

Version	SD	Article No.	Price per PU	PU (UNIT, SET, M)	PS*
Galvanic isolation plates					
 3RQ3900-0A	d	For electrical separation of different potentials when devices of different types are installed side by side 3RQ3900-0A		1	10 units
Connecting combs					
 3RQ3901-0B		For linking the same potentials, current carrying capacity for infeed max. 6 A • 2-pole • 4-pole • 8-pole • 16-pole		1	10 units
	2	3RQ3901-0A		1	10 units
	2	3RQ3901-0B		1	10 units
	2	3RQ3901-0C		1	10 units
	2	3RQ3901-0D		1	10 units
Clip-on labels¹⁾					
 3RQ3902-0A		For terminal and equipment labeling, white • 5 x 5 mm • 6 x 12 mm		100	2 000 units
	2	3RQ3902-0A		100	2 000 units
	2	3RQ3902-0B		100	1 200 units
Tools for opening spring-type terminals					
 3RA2908-1A		Screwdriver For all SIRIUS devices with spring-type terminals; 3,0 mm x 0.5 mm, length approx. 200 mm, titanium gray/black, partially insulated		1	1 unit
	2	Spring-type terminals (push-in) 3RA2908-1A			

¹⁾ PC labeling system for individual inscription of unit labeling plates available from Conta-Clip Verbindungstechnik GmbH (see page 16/16).

Coupling relays with plug-in relay	Control supply voltage	Material of switching contacts	Number of CO contacts for auxiliary contacts	SD	Article No.	Price per PU	PU (UNIT, SET, M)	PS*
Type	V			d				
Replacement modules for 3RQ3118 coupling relays with plug-in relay								
3RQ3118-.AM00	24 DC	AgSnO2	1	2	3TX7014-7BM00		1	15 units
3RQ3118-.AM01		AgSnO2 hard gold-plated		2	3TX7014-7BM02		1	15 units
3RQ3118-.AB00	24 AC/DC	AgSnO2	1	2	3TX7014-7BM00		1	15 units
3RQ3118-.AB01		AgSnO2 hard gold-plated		2	3TX7014-7BM02		1	15 units
3RQ3118-.AE00	115 AC/DC	AgSnO2	1	2	3TX7014-7BP00		1	15 units
3RQ3118-.AF00	230 AC/DC	AgSnO2						
3RQ3118-.AE01	115 AC/DC	AgSnO2 hard gold-plated	1	2	3TX7014-7BP02		1	15 units
3RQ3118-.AF01	230 AC/DC	AgSnO2 hard gold-plated						

Overview



SIRIUS 3RQ2 coupling relays, screw terminals, 3 changeover contacts

More information

Homepage, see www.usa.siemens.com/relays

Industry Mall, see www.siemens.com/product?3RQ2

For the conversion tool, e.g. from 3RS18 to 3RQ2, see www.siemens.com/sirius/conversion-tool

3RQ2 coupling relays in their 22.5 mm industrial enclosure serve to couple control signals to and from a controller and replace the 3RS18 coupling relays. The 3RQ2 has an impressively high-quality industrial enclosure finished in modern titanium gray so that it fits in visually with the SIRIUS series of relays.

The series consists of devices with up to three changeover contacts with screw or spring-type terminals (push-in) and, with its wide voltage range from 24 to 240 V AC/DC, is a genuine highlight in the coupling relay market.

Thanks to terminal assignment that is identical to the previous version, existing products can easily be converted.

The reduced variety of components simplifies product selection and standardization.

Numerous accessories are available for the 3RQ2 coupling relays, for example replacement terminals, push-in lugs for wall mounting and coding pins.

Article No. scheme

Product versions		Article number			
Coupling relays, standard		3RQ2000 – □ □ □ 0 □			
Connection methods	Screw terminals	1			
	Spring-type terminals (push-in)	2			
Outputs	1 CO contact		A		
	2 CO contacts		B		
	3 CO contacts		C		
Rated control supply voltage	24 ... 240 V AC/DC		W		
Material of switching contacts	0 = AgSnO2				0
	1 = AgNi +Au				1
Example		3RQ2000 – 1 C W 0 1			

Note:

The Article No. scheme shows an overview of product versions for better understanding of the logic behind the article numbers.

For your orders, please use the article numbers quoted in the selection and ordering data.

Benefits

- Permanent wiring thanks to removable terminals in screw or spring-type technology (push-in)
- Replacement of individual terminals minimizes wiring effort
- A product for all voltages from 24 to 240 V AC/DC
- Reduced costs thanks to fewer versions
- Especially high contact reliability even at low currents thanks to versions with hard gold-plated contacts
- International standards and certifications including CE, UL/CSA, EAC and confirmations for rail, and more

Application

- Electrical separation between the input and output circuit
- Adjustment of different signal levels
- Signal amplification
- Contact multiplication

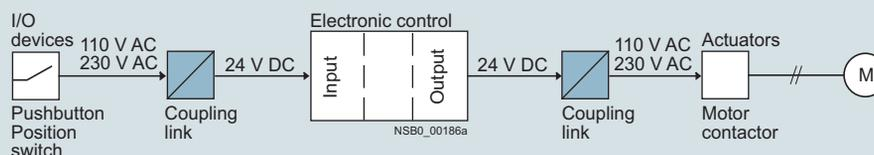

Application example motor controller

Technical specifications

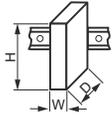
More information		
Technical specifications, see https://support.industry.siemens.com/cs/ww/en/ps/25158/td	Operating instructions, see https://support.industry.siemens.com/cs/ww/en/ps/25158/man	
Type	3RQ2000-.AW00 3RQ2000-.BW00 3RQ2000-.CW00	3RQ2000-.CW01
General data		
Dimensions (W x H x D)	 mm	22.5 x 100 x 90
Insulation voltage for overvoltage category III acc. to IEC 60664 for pollution degree 3	V	300
Max. permissible voltage for protective separation between control circuit and auxiliary circuit acc. to IEC 60947-1	V	300
Ambient temperature		
• During operation	°C	-25 ... +60
• During storage	°C	-40 ... +80
Degree of protection		IP20
Control circuit		
Control supply voltage	V	24 ... 240 AC/DC; 50/60 Hz
Operating range factor of control supply voltage		0.7 ... 1.1
Load circuit		
Thermal current of the non-solid-state contact blocks, maximum	A	5
Current carrying capacity of the output relay		
• At AC-15 at 250 V	A	3
• At DC-13 at 24 V	A	1
• At DC-13 at 125 V	A	0.2
• At DC-13 at 250 V	A	0.1
Mechanical endurance (operating cycles) typical		10 000 000
Electrical endurance (operating cycles) for AC-15 at 230 V, typical		100 000
Material of switching contacts		AgSnO2 AgNi + Au
Article number	3RQ2000-1	3RQ2000-2
Type of electrical connection	 Screw terminals	 Spring-type terminals (push-in)
Type of connectable conductor cross-sections		
• Solid	mm ²	1x (0.5 ... 4.0 mm ²), 2x (0.5 ... 2.5 mm ²)
• Finely stranded with end sleeve	mm ²	1x (0.5 ... 4 mm ²), 2x (0.5 ... 1.5 mm ²)
• Solid for AWG cables	AWG	1x (20 ... 12), 2x (20 ... 14)
Tightening torque	Nm	0.6 ... 0.8 --

Coupling Relays

Coupling Relays with Industrial Enclosure

SIRIUS 3RQ2 **NEW**

Selection and ordering data

PU (UNIT, SET, M) = 1
PS* = 1 UNIT

	Control supply voltage		Number of CO contacts for auxiliary contacts	Material of switching contacts	SD	Screw terminals 		Spring-type terminals (push-in) 	
	at AC at 50 Hz	At DC				Article No.	Price per PU	Article No.	Price per PU
	V	V	W		d				
Coupling relays in industrial enclosure, 22.5 mm									
 3RQ2000-1CW00	24 ... 240	24 ... 240	1	AgSnO2	2	3RQ2000-1AW00	2	3RQ2000-2AW00	
			2	AgSnO2	2	3RQ2000-1BW00	2	3RQ2000-2BW00	
			3	AgSnO2	2	3RQ2000-1CW00	2	3RQ2000-2CW00	
			3	AgNi + Au	2	3RQ2000-1CW01	2	3RQ2000-2CW01	

Accessories

More information

Operating instructions, see <https://support.industry.siemens.com/cs/ww/en/ps/25158/man>

Conversion tool, e.g. from 3RS18 to 3RQ2, see www.siemens.com/sirius/conversion-tool

Version	SD	Article No.	Price per PU	PU (UNIT, SET, M)	PS*
	d				

Terminals for SIRIUS devices in the industrial standard mounting rail enclosure

 3ZY1122-1BA00	Removable terminals		Screw terminals 		PU	PS*
	• 2-pole, up to 1 x 4 mm ² or 2 x 2.5 mm ²	2	3ZY1122-1BA00	1		
	• 2-pole, up to 1 x 4 mm ² or 2 x 1.5 mm ²	2	Spring-type terminals (push-in) 	1	6 units	
		2	3ZY1122-2BA00	1	6 units	

Accessories for enclosures

 3ZY1450-1AB00	Hinged cover replacement cover, without terminal labeling, titanium gray, 22.5 mm wide	2	3ZY1450-1AB00	1	5 units
 3ZY1311-0AA00	Push-in lugs For wall mounting	2	3ZY1311-0AA00	1	10 units
 3ZY1440-1AA00	Coding pins For removable terminals of SIRIUS devices in the industrial standard mounting rail enclosure; they enable the mechanical coding of terminals	2	3ZY1440-1AA00	1	12 units

Tools for opening spring-type terminals

 3RA2908-1A	Screwdrivers For all SIRIUS devices with spring-type terminals 3.0 mm x 0.5 mm, length approx. 200 mm, titanium gray/black, partially insulated	2	Spring-type terminals (push-in) 	1	1 unit
			3RA2908-1A		

More information**Code conversion table**

SIRIUS 3RS18 coupling relays				Comparison type SIRIUS 3RQ2 coupling relays			
Screw terminals	Spring-type terminals	Version	Contacts	Screw terminals	Spring-type terminals (push-in)	Version	Contacts
3RS1800-1AQ00	3RS1800-2AQ00	24 V AC/DC; 110 ... 120 V AC	1 CO contact	3RQ2000-1AW00	3RQ2000-2AW00	24 ... 240 V AC/DC	1 CO contact
3RS1800-1AP00	3RS1800-2AP00	24 V AC/DC; 220 ... 240 V AC					
3RS1800-1BW00	3RS1800-2BW00	24 ... 240 V AC/DC	2 CO contacts	3RQ2000-1BW00	3RQ2000-2BW00	24 ... 240 V AC/DC	2 CO contacts
3RS1800-1BQ00	3RS1800-2BQ00	24 V AC/DC; 110 ... 120 V AC					
3RS1800-1BP00	3RS1800-2BP00	24 V AC/DC; 220 ... 240 V AC					
3RS1800-1HW00	3RS1800-2HW00	24 ... 240 V AC/DC	3 CO contacts	3RQ2000-1CW00	3RQ2000-2CW00	24 ... 240 V AC/DC	3 CO contacts
3RS1800-1HQ00	3RS1800-2HQ00	24 V AC/DC; 110 ... 120 V AC					
3RS1800-1HP00	3RS1800-2HP00	24 V AC/DC; 220 ... 240 V AC					
3RS1800-1HW01	3RS1800-2HW01	24 ... 240 V AC/DC	3 CO contacts, hard gold-plated	3RQ2000-1CW01	3RQ2000-2CW01	24 ... 240 V AC/DC	3 CO contacts, hard gold-plated
3RS1800-1HQ01	3RS1800-2HQ01	24 V AC/DC; 110 ... 120 V AC					
3RS1800-1HP01	3RS1800-2HP01	24 V AC/DC; 220 ... 240 V AC					

Overview



SIRIUS 3RS70 signal converters

More information

Homepage, see www.usa.siemens.com/relays
 Industry Mall, see www.siemens.com/product?3RS70
 For the conversion tool, e.g. from 3RS17 to 3RS70, see www.siemens.com/sirius/conversion-tool

Signal converters perform the coupling function for analog signals on both the input side and the output side. They are indispensable when processing analog values with electronic controls. Under harsh industrial conditions in particular, it is often necessary to transmit analog signals over long distances. Electrical separation is then needed as a result of the different power supplies. The resistance of the wiring causes potential differences and losses which must be prevented.

Electromagnetic disturbance and overvoltages can affect the signals on the input side in particular or even destroy the analog modules. All terminals of the 3RS70 signal converters are safe up to a voltage of 30 V DC and protected against switching poles. Short-circuit protection is an especially important function for the outputs.

The devices are EMC-tested according to

- IEC 61000-6-4 (generic standard for emitted interference)
- IEC 61000-6-2 (generic standard for interference immunity)

The analog signals comply with

- IEC 60381-1/2

Article No. scheme

Product versions		Article number								
Signal converters		3RS70	<input type="checkbox"/>	<input type="checkbox"/>	-	<input type="checkbox"/>	<input type="checkbox"/>	<input type="checkbox"/>	<input type="checkbox"/>	0 0 0
Product function/type of input signal	Single-range converters, active	0 0								3-way separation, input 0 ... 10 V
		0 2								3-way separation, input 0 ... 20 mA,
		0 3								3-way separation, input 4 ... 20 mA,
	Switchable multi-range converters, active	0 5								3-way separation, 3 standard signals can be switched 0 ... 10 V, 0/4 ... 20 mA
	Switchable universal converters, active	0 6								3-way separation, 16 signals can be switched
	Single-range converters, passive	2 0								2-way separation, 4 ... 20 mA
	Switchable multi-range converters, active	2 5								3-way separation, with manual/automatic switch and setting potentiometer
Connection type	Screw terminals								1	
	Spring-type terminals (push-in)								2	
Type of output signal	0 ... 10 V									A
	0 ... 20 mA									C
	4 ... 20 mA									D
	Loop power isolator 4 ... 20 mA									E
	3 standard signals can be switched									F
	4 frequencies can be switched									K
Supply voltage	24 V AC/DC									E
	None									T
	24 ... 240 V AC/DC									W
Example		3RS70	0 0	-	1	A	E	0 0		

Note:

The Article No. scheme shows an overview of product versions for better understanding of the logic behind the article numbers.

For your orders, please use the article numbers quoted in the selection and ordering data.

Benefits

- Narrow width
- Easy-to-set universal converters
- Converters with frequency output
- All ranges are fully calibrated
- Universal family of devices – the perfect solution for every application
- Integrated manual/automatic switch with a setpoint generator
- Outputs are short-circuit-proof
- Up to 30 V – protected against damage caused by wiring errors

Application

- Signal converters are used in analog signal processing for
- Electrical separation
 - Conversion of normalized and non-normalized signals
 - Amplification and impedance adaptation
 - Conversion to a frequency for processing by a digital input
 - Overvoltage and EMC protection
 - Short-circuit protection of the outputs

3RS7025 manual/automatic converter

For special applications in which analog signals have to be simulated, or during plant commissioning when the actual process value is not yet available, the 3RS7025 devices feature an adjustable potentiometer for manual setpoint selection and a manual/automatic switch.

The potentiometer for the 3RS7025 devices is used to simulate analog output signals when the changeover switch is set to "Manual" and the control supply voltage is applied, without the need for an analog input signal. The scale ranges from 0 ... 100%.

Example: When it is set for an output of 4 ... 20 mA, the left stop on the potentiometer represents an output current of 4 mA and the right stop represents an output current of 20 mA. In the "Auto" switch position, the output signal follows the input signal proportionally regardless of the potentiometer setting.

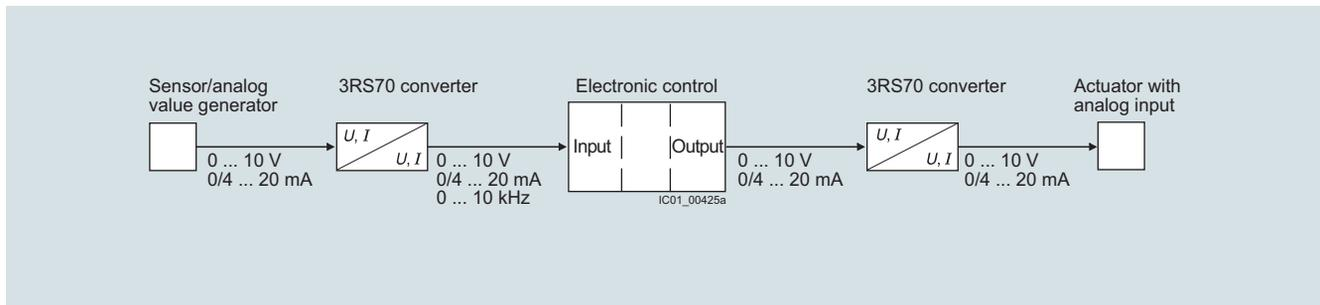

Application example of analog signal processing

Technical specifications

More information

Technical specifications, see
<https://support.industry.siemens.com/cs/ww/en/ps/16691/td>

Circuit diagrams, see
<https://support.industry.siemens.com/cs/ww/en/view/109475738>

Operating instructions, see
<https://support.industry.siemens.com/cs/ww/en/view/109475738>

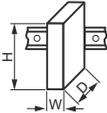
Article number	3RS7000-.AE00	3RS7002-.AE00, 3RS7003-.AE00	3RS7000-.CE00, 3RS7000-.DE00	3RS7002-.CE00, 3RS7002-.DE00, 3RS7003-.CE00, 3RS7003-.DE00	3RS7020-.ET00
Product designation Product version	Single-range converters, active				Single-range converters, passive
General data:					
Width x height x depth	 mm				6.2 x 93 x 71
Ambient temperature					
• During operation	°C	-25 ... +60			
• During storage	°C	-40 ... +80			
Relative humidity during operation	%	10 ... 95			
Insulation voltage for overvoltage category III to IEC 60664 for pollution degree 3 rated value	V	50			
Active power input	W	0.29			
Degree of protection		IP20			
Input:					
Input voltage					
• Max.	V	30			
Input impedance					
• Of current input, maximum	Ω	--	100	--	100
• Of voltage input, minimum	kΩ	330	--	330	--
Output:					
Load					
• Maximum at current output	Ω	--	500		1 000
• Minimum at voltage output	kΩ	2	--		--
Relative measuring accuracy	%	0.1			
Short-circuit-proof		Yes			
					No

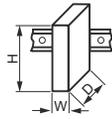
Article number		3RS7005-.FE00	3RS7005-.KE00	3RS7005-.FW00	3RS7005-.KW00	3RS7025-.FE00	3RS7025-.FW00
Product designation Product version		Switchable multi-range converters, active				Switchable multi-range converters, active, with manual/automatic switch and setting potentiometer	
General data:							
Width x height x depth	 mm	6.2 x 93 x 72.5		17.5 x 93 x 72.5		17.5 x 93 x 75	
Ambient temperature							
• During operation	°C	-25 ... +60					
• During storage	°C	-40 ... +80					
Relative humidity during operation	%	10 ... 95					
Insulation voltage for overvoltage category III to IEC 60664 for pollution degree 3 rated value	V	50		300		50 300	
Active power input	W	0.29		0.5 0.34		0.5	
Degree of protection		IP20					
Input:							
Input voltage							
• Max.	V	30					
Input impedance							
• Of current input, maximum	Ω	100					
• Of voltage input, minimum	kΩ	330					
Output:							
Load							
• Maximum at current output	Ω	500		500		500	
• Minimum at voltage output	kΩ	2		2		2	
Relative measuring accuracy	%	0.1					
Short-circuit-proof		Yes					

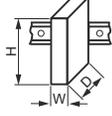
Article number	3RS7006-FE00	3RS7006-FW00
Product designation Product version	Switchable universal converters, active	
General data:		
Width x height x depth	 mm	17.5 × 93 × 72.5
Ambient temperature		
• During operation	°C	-25 ... +60
• During storage	°C	-40 ... +80
Relative humidity during operation	%	10 ... 95
Insulation voltage for overvoltage category III to IEC 60664 for pollution degree 3 rated value	V	50
Active power input	W	0.5
Degree of protection	IP20	
Input:		
Input voltage		
• Max.	V	30
Input impedance		
• Of current input, maximum	Ω	100
• Of voltage input, minimum	kΩ	330
Output:		
Load		
• Maximum at current output	Ω	500
• Minimum at voltage output	kΩ	2
Relative measuring accuracy	%	0.1
Short-circuit-proof	Yes	

Article number	3RS70..-1....	3RS70..-2....
Type of electrical connection	 Screw terminals	 Spring-type terminals (push-in)
Type of connectable conductor cross-sections		
• Solid	1x (0.25 ... 2.5 mm ²)	1x (0.25 ... 2.5 mm ²)
• Finely stranded	--	1x (0.25 ... 2.5 mm ²)
- Without end sleeves	1x (0.25 ... 1.5 mm ²)	1x (0.25 ... 1.5 mm ²)
- With end sleeves	1x (20 ... 14)	1x (20 ... 14)
• Solid for AWG cables		

Selection and ordering data

Signal type At the input	At the output	Supply voltage	Width mm	SD d	Article No.	Price per PU	PU (UNIT, SET, M)	PS*
Single-range converters								
<i>Passive</i>								
Type of electrical isolation, 2-way								
4 ... 20 mA	4 ... 20 mA	--	6.2	2	3RS7020-□ET00		1	1 unit
Single-range converters								
<i>Active</i>								
Type of electrical isolation, 3-way								
0 ... 10 V	0 ... 10 V	24 V AC/DC	6.2	2	3RS7000-□AE00		1	1 unit
0 ... 20 mA	0 ... 10 V	24 V AC/DC	6.2	2	3RS7002-□AE00		1	1 unit
4 ... 20 mA	0 ... 10 V	24 V AC/DC	6.2	2	3RS7003-□AE00		1	1 unit
0 ... 10 V	0 ... 20 mA	24 V AC/DC	6.2	2	3RS7000-□CE00		1	1 unit
0 ... 20 mA	0 ... 20 mA	24 V AC/DC	6.2	2	3RS7002-□CE00		1	1 unit
4 ... 20 mA	0 ... 20 mA	24 V AC/DC	6.2	2	3RS7003-□CE00		1	1 unit
0 ... 10 V	4 ... 20 mA	24 V AC/DC	6.2	2	3RS7000-□DE00		1	1 unit
0 ... 20 mA	4 ... 20 mA	24 V AC/DC	6.2	2	3RS7002-□DE00		1	1 unit
4 ... 20 mA	4 ... 20 mA	24 V AC/DC	6.2	2	3RS7003-□DE00		1	1 unit
Multi-range converters								
<i>Active, switchable</i>								
Type of electrical isolation, 3-way								
0 ... 10 V, 0 ... 20 mA, 4 ... 20 mA	0 ... 10 V, 0 ... 20 mA, 4 ... 20 mA	24 V AC/DC 24 ... 240 V AC/DC	6.2 17.5	2	3RS7005-□FE00 3RS7005-□FW00		1	1 unit
		24 V AC/DC	6.2	2	3RS7005-□KE00		1	1 unit
		24 ... 240 V AC/DC	17.5	2	3RS7005-□KW00		1	1 unit
		0 ... 50 Hz 0 ... 100 Hz 0 ... 1 kHz 0 ... 10 kHz						
Multi-range converters								
<i>Active, with manual/automatic switch and setting potentiometer</i>								
Type of electrical isolation, 3-way								
0 ... 10 V, 0 ... 20 mA, 4 ... 20 mA	0 ... 10 V, 0 ... 20 mA, 4 ... 20 mA	24 V AC/DC 24 ... 240 V AC/DC	17.5	2	3RS7025-□FE00 3RS7025-□FW00		1	1 unit
Universal converters								
<i>Active, switchable</i>								
Type of electrical isolation, 3-way								
0 ... 60 mV, 0 ... 100 mV, 0 ... 300 mV, 0 ... 500 mV, 0 ... 1 V, 0 ... 2 V, 0 ... 5 V, 0 ... 10 V, 0 ... 20 V, 2 ... 10 V, 0 ... 5 mA, 0 ... 10 mA, 0 ... 20 mA, 4 ... 20 mA, -5 ... +5 mA, -20 ... +20 mA	0 ... 10 V, 0 ... 20 mA, 4 ... 20 mA	24 V AC/DC 24 ... 240 V AC/DC	17.5	2	3RS7006-□FE00 3RS7006-□FW00		1	1 unit
Type of electrical connection								
<ul style="list-style-type: none"> • Screw terminals • Spring-type terminals (push-in) 								



3RS7000-1AE00



3RS7000-2AE00



3RS7005-1FW00



3RS7006-1FE00

Accessories

Version	SD	Article No.	Price per PU	PU (UNIT, SET, M)	PS*
Galvanic isolation plates					
		Galvanic isolation plates For electrical separation of different potentials when devices of different types are installed side by side		1	10 units
3RQ3900-0A	2	3RQ3900-0A			
Connecting combs					
		Connecting combs For linking the same potentials, current carrying capacity for infeed max. 6 A			
3RQ3901-0B	2	3RQ3901-0A		1	10 units
	2	3RQ3901-0B		1	10 units
	2	3RQ3901-0C		1	10 units
	2	3RQ3901-0D		1	10 units
Clip-on labels					
		Clip-on labels For terminal marking and equipment labeling, white			
	2	3RQ3902-0A		100	2 000 units
Tools for opening spring-type terminals					
		Screwdrivers For all SIRIUS devices with spring-type terminals; 3.0 mm x 0.5 mm; length approx. 200 mm, titanium gray/black, partially insulated			
3RA2908-1A	2	3RA2908-1A	Spring-type terminals (push-in) 	1	1 unit

Function Relays, Interfaces and Converters

Coupling Relays and Interfaces

3TG10 power relays

Overview

Version

The 3TG10 contactors with 4 main contacts are available with screw-type terminals or with 6.3 mm to 0.8 mm tab connectors. The designs with screw-type terminals are suitable for use in any climate and safe from touch to DIN VDE 0106 Part 100.

The 3TG10 contactors have a compact design. Their overall width is 36 mm.

Application

They are suitable for use in household appliances as well as for distribution boards in offices and residential buildings, owing to their hum-free construction. They can further be used in all areas where there is only a limited amount of space available, e.g. in air conditioners, heating systems, pumps and fans - basically in all simple electrical controls.

AC and DC operation

EN 60 947-4-1
(VDE 0660 Part 102).

Surge suppression

The 3TG10 contactors are fitted with an integrated protective circuit for damping opening surges.

Overload and short-circuit protection

The 3UA7 overload relay can be used for overload protection (see NS E catalogue, available in German). This applies both for contactor mounting and for mounting as a single unit.

The data for short-circuit protection of the contactors without using an overload relay are provided in the technical data.

Selection and ordering data

Ratings Utilization category			Main contacts	Rated control supply voltage U_c	Order No.	List Price \$	Weight approx.	Pack
AC-1 maximum resistive load	Horsepower ratings of three-phase loads at 50 Hz 400 V	AC-3 maximum inductive current	Design 				kg	Units
A	kW	A	NO NC					

With screw connections, 4-pin for screwing and snapping onto 35 mm standard mounting rail · hum-free

• AC operation

	3TG10 ...0	20	5	8.4	4 -	230 V, 45–450 Hz 110 V, 45–450 Hz 24 V, 45–450 Hz	3TG10 10-0AL2 3TG10 10-0AG2 3TG10 10-0AC2	0.15	10
					3 1	230 V, 45–450 Hz 110 V, 45–450 Hz 24 V, 45–450 Hz	3TG10 01-0AL2 3TG10 01-0AG2 3TG10 01-0AC2	0.15	10

• DC operation

	20	5	8.4	4 -	DC 24 V	3TG10 10-0BB4 3TG10 01-0BB4	0.15	10
				3 1	DC 24 V			

With tab connectors 6.3 x 0.8 mm, 4-pin for screwing and snapping onto 35 mm standard mounting rail · hum-free

• AC operation

	3TG10 ...-1	16	5	8.4	4 -	230 V, 45–450 Hz 110 V, 45–450 Hz 24 V, 45–450 Hz	3TG10 10-1AL2 3TG10 10-1AG2 3TG10 10-1AC2	0.14	10
					3 1	230 V, 45–450 Hz 110 V, 45–450 Hz 24 V, 45–450 Hz	3TG10 01-1AL2 3TG10 01-1AG2 3TG10 01-1AC2	0.14	10

• DC operation

	16	5	8.4	4 -	DC 24 V	3TG10 10-1BB4 3TG10 01-1BB4	0.14	10
				3 1	DC 24 V			

1) The links for paralleling can be reduced by one pole. The rated operational currents are valid for each pole. The links for paralleling are insulated.

Function Relays, Interfaces and Converters

Coupling Relays and Interfaces

3TG10 power relays

Technical data					
General data					
Mechanical endurance	operating cycles				3 mill.
Electrical endurance at I_e	operating cycles	AC-1 AC-3			0.1 million 0.4 million
Rated insulation voltage U_i (pollution degree 3)			V		400
Rated impulse withstand voltage U_{imp}			kV		4
Safe isolation acc. to DIN VDE 0106 Part 101 and A1 (draft 2/89) between coil and contacts			V		up to 300
Permissible ambient temperature	in operation ¹⁾		°C		-25 ... +55
	when stored		°C		-50 ... +80
Degree of protection acc. to IEC 60 947-1 and IEC 60 529 (VDE 0470 Part 1)					IP 00, coil system IP 20
Power consumption of the coils (with coil in cold state and $1.0 \times U_s$)	AC operation 45 – 450 Hz		VA		4.4
	p.f.				0.9 (hum-free)
	DC operation		W		4
Coil voltage tolerance					0.85 to $1.1 \times U_s$
Operating times (break-time = opening time + arcing time)				AC operation	DC operation
	Closing	closing time	NO ms	10 ... 50	11 ... 50
		opening time	NC ms	5 ... 45	5 ... 45
	Opening	opening time	NO ms	20 ... 30	19 ... 35
		closing time	NC ms	20 ... 30	21 ... 39
	Arcing time		ms	10 to 15	
Shock resistance					
rectangular pulse	AC and DC operation		g/ms		5.1/5 and 3.5/10
sine pulse	AC and DC operation		g/ms		7.9/5 and 5.2/10
Operating frequency z in operating cycles per hour					
Rated operation	No-load op. frequency		1/h		10000
	for AC-1		1/h		1000
	for AC-2		1/h		500
	for AC-3		1/h		1000
Short-circuit protection					
Fuse links					
Utilisation category gL/gG	NH	Type 3NA			
	DIAZED	Type 5SB			
	NEOZED	Type 5SE			
acc. to IEC 60 947-4-1 (DIN VDE 0660 Part 102)	Type of coordination "1"		A		25
	Type of coordination "2"		A		10
Miniature circuit-breaker	C-characteristic		A		10
Load ratings with AC					
AC-1 utilisation category, switching resistive load					
Rated operational current I_e at 55 °C to 400 V ¹⁾					
with screw connection			A		20
with tab connector			A		16
Ratings U_e of three-phase loads p.f. = 1			V		400
with screw connection			kW		13
with tab connector			kW		10
Minimum conductor cross-section with $I_{e \text{ load}}$			mm ²		2.5

1) If the three main conducting paths are loaded with 20 A and $I > 10$ A for the fourth conducting

path: the permissible ambient temperature is 40 °C.

Function Relays, Interfaces and Converters

Coupling Relays and Interfaces

3TG10 power relays

Technical data										
Load ratings with AC										
AC-2 and AC-3 utilisation categories										
Rated operational currents I_e up to 400 V	A	8.4								
Ratings of motors with slipping or squirrel-cage rotor at 50 Hz and 60 Hz and at 400 V	kW	4								
AC-5a utilisation category (permissible supply impedance: $\geq 0.5 \Omega$)										
Switching gas discharge lamps per main conducting path at 50 Hz 230 V										
		Uncorrected			Lead-lag					
Rating per lamp	W	18	36	58	18	36	58			
Rated operational current per lamp	A	0.37	0.43	0.67	2 x 0.11	2 x 0.21	2 x 0.32			
Number of lamps	unit	43	37	24	2 x 81	2 x 42	2 x 28			
Switching gas discharge lamps with correction, electronic ballast per main conducting path at 50 Hz 230 V										
		Parallel correction			Electr. ballast, 1 lamp		Electr. ballast, 2 lamps			
Rating per lamp	W	18	36	58	18	36	58	18	36	58
Capacitor	μF	4.5	4.5	7	6.8	6.8	10	10	10	22
Rated operational current per lamp	A	0.11	0.21	0.32	0.10	0.18	0.27	0.18	0.35	0.52
Number of lamps	unit	15	15	10	39	39	26	2 x 26	2 x 26	2 x 1
AC-5b utilisation category, switching incandescent lamps per main conducting path at 50 Hz 230 V										
	kW	1.6								
Load ratings with DC										
DC-1 utilisation category, switching resistive load ($\frac{L}{R} \leq 1 \text{ ms}$)										
Rated operational current I_e										
		Conducting paths connected in series		1	2	3	4			
		up to 24 V	A	16	16	18	20			
		60 V	A	6	16	18	20			
		110 V	A	2	6	16	20			
		220 V/240 V	A	0.8	1.6	6	20			
DC-3 and DC-5 utilisation categories, shunt and series motors ($\frac{L}{R} \leq 15 \text{ ms}$)										
Rated operational current I_e										
		Conducting paths connected in series		1	2	3	4			
		up to 24 V	A	10	16	16	18			
		60 V	A	0.5	5	16	16			
		110 V	A	0.15	0.35	10	10			
		220 V/240 V	A	–	–	1.75	2			
Conductor cross-sections for designs										
with screw connections										
Screw connection		M3								
Finely stranded with end sleeve (DIN 46 228, style A/D/C)	mm ²	2 x (0.75 to 2.5)								
Solid	mm ²	2 x (1 to 2.5)								
	mm ²	1 x 4								
with tab connectors										
Finely stranded		6.3 to 1	mm ²	0.5 to 1						
When using push-on contact acc. to DIN 46 245/46 247		6.3 to 2.5	mm ²	1 to 2.5						
Ⓢ and Ⓜ ratings (screw connection)										
Rated insulation voltage										
	AC	V	600							
Conventional thermal current										
	Free air and enclosed	A	20							
Maximum horsepower ratings (Ⓢ and Ⓜ-approved values)										
Ratings of three-phase motors at 60 Hz										
				1-phase	3-phase					
	at 115 V	hp		1/2	–					
	200 V	hp		1	3					
	230 V	hp		1 1/2	3					
	460 V/575 V	hp		–	5					
	600 V	hp		–	5					

Function Relays, Interfaces and Converters

Coupling Relays and Interfaces

3TG10 power relays

Accessories

For contactor	Design	Order No.	List Price \$	Weight approx.	Pack
Type	Max. rated operational currents $I_{th}/AC-1$ (at 55 °C) of contactors A	Max. conductor cross-sections mm ²	PG 101	kg	Units

Links for paralleling (star jumpers)

• 3-pole without terminal ¹⁾²⁾					
3TG10	16 Star jumpers can be reduced by one pole	–	3RT1 916-4BA31	0.004	1
• 3-pole with terminal ¹⁾³⁾					
3TG10	40	25	3RT1 916-4BB31	0.013	1
• 4-pole with terminal ¹⁾⁴⁾					
3TG10	50	25	3RT1 916-4BB41	0.02	1

Circuit diagrams

Position of terminals

3TG10 10
1 NO

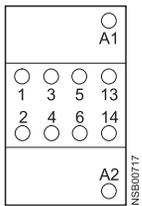

3TG10 01
1 NC

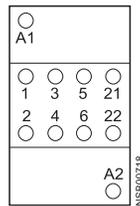

Internal circuit diagram

3TG10 10
1 NO
Ident. 10E

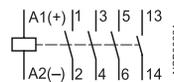

3TG10 01
1 NC
01E

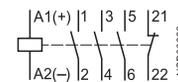

Dimension drawings

AC and DC operation

3TG10 ..-0..
with screw connections

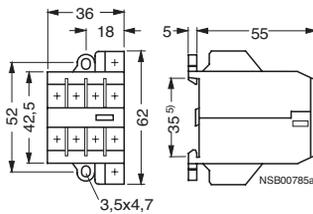

3TG10 ..-1..
with tab connectors

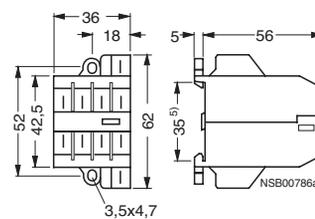

Accessories for 3TG10

3RT19 16-4BB41 links for paralleling, 4-pole, with terminal

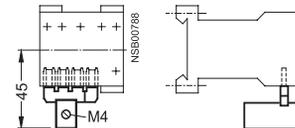

The links for paralleling can be reduced by one pole.

- 1) The links for paralleling can be reduced by one pole. The rated operational currents are valid for each pole. The links for paralleling are insulated.
- 2) Replacement type for 3TX44 90-2C.
- 3) Replacement type for 3TX44 90-2A.
- 4) Replacement type for 3TX44 90-2B.
- 5) Can be snapped onto 35 mm standard mounting rails.

Coupling Relays and Interfaces

3TX71 and LZS plug-in relays

Selection and ordering data

Siemens offers two lines of plug-in style relays to meet your industrial needs – **3TX71** and **LZS**.



3TX71 relays are available as open power, enclosed power and plug-in style relays. The plug-in family includes basic, premium and bifurcated styles, screw terminals only, and must be ordered as individual components; the selection guide shows which base and accessories belong with which relay. Basic style relays are the most economical and are equipped with a mechanical flag indicator only. Premium style relays offer LED and mechanical flag indication, push-to-test and a latching function for testing without power to the coil. Premium Bifurcated style relays are ideal for low minimum holding current requirements on the contacts (3mA vs. 100mA).



LZS plug-in relays can be ordered as complete units or as individual components and are available with screw or push-in terminals. Complete unit order numbers include the relay, base, LED (with surge suppression in 24VDC version) and retainer/ejector clip and are available with changeover contacts (1CO to 4CO) and coil voltages from 12VDC to 230VAC. PT & MT versions have a push-to-test and a latching function for testing without power to the coil. RT versions are miniature, only 15mm wide and feature 1CO or 2CO contacts. MT versions are 11-pin octal base relays, with 3CO contacts with or without LED and components must be ordered individually.

Square Base (Narrow)

Contacts	Contact Rating (A)	Coil Voltage	Basic Relay	Premium Relay	Uses Socket 3TX7144-	Uses Clip 3TX7144-	Socket Access Set
SPDT	15	12VDC	3TX7110-5BB03C	3TX7110-5JB03	4E7	1L7	B
		24 VDC	3TX7110-5BC03C	3TX7110-5JC03	4E7	1L7	B
		24 VAC	3TX7110-5BC13C	3TX7110-5JC13	4E7	1L7	B
		120 VAC	3TX7110-5BF13C	3TX7110-5JF13	4E7	1L7	B
		240 VAC	—	3TX7110-5JG13	4E7	1L7	B



Square Base (Standard)

Contacts	Contact Rating (A)	Coil Voltage	Basic Relay	Premium Relay	Uses Socket 3TX7144-	Uses Clip 3TX7144-	Socket Access Set
DPDT	12	24 VDC	3TX7111-3DC03C	3TX7111-3LC03	4E5	1L11	B
		24 VAC	3TX7111-3DC13C	3TX7111-3LC13	4E5	1L11	B
		120 VAC	3TX7111-3DF13C	3TX7111-3LF13	4E5	1L11	B
DPDT	15	12 VDC	3TX7114-5DB03C	3TX7114-5LB03	4E6	1L11	B
		24VDC	3TX7114-5DC03C	3TX7114-5LC03	4E6	1L11	B
		24VAC	3TX7114-5DC13C	3TX7114-5LC13	4E6	1L11	B
		120 VAC	3TX7114-5DF13C	3TX7114-5LF13	4E6	1L11	B
		240 VAC	—	3TX7114-5LH13	4E6	1L11	B
DPDT	10	12 VDC	3TX7115-5DB03C	—	4E4	1L12	A
		24VDC	3TX7115-5DC03C	3TX7115-5LC03	4E4	1L12	A
		24VAC	3TX7115-5DC13C	3TX7115-5LC13	4E4	1L12	A
		120 VAC	3TX7115-5DF13C	3TX7115-5LF13	4E4	1L12	A



Option	Basic	Premium
Mechanical Flag	✓	✓
Push To Test		✓
Lock Down Door		✓
LED		✓

Note: See page 11/139 for socket accessories.

Coupling Relays and Interfaces

3TX71 plug-in relays

Selection and ordering data



Square Base (Standard)

Contacts	Contact Rating (A)	Coil Voltage	Basic Relay	Premium Relay	Premium Bifurcated	Uses Socket 3TX7144-	Uses Clip 3TX7144-	Socket Access Set
3PDT	15	24VDC	3TX7116-5FC03C	3TX7116-5NC03	—	4E8	1L9	A
		24VAC	3TX7116-5FC13C	3TX7116-5NC13	—	4E8	1L9	A
		120 VAC	3TX7116-5FF13C	3TX7116-5NF13	—	4E8	1L9	A
3PDT	10	24VDC	3TX7115-5FC03C	3TX7115-5NC03	—	4E4	1L12	A
		120 VAC	3TX7115-5FF13C	3TX7115-5NF13	—	4E4	1L12	A
4PDT	6A for Basic and Premium and 3A for Bifurcated	24VDC	3TX7111-3HC03C	3TX7111-3PC03	3TX7111-5PC03B	4E5	1L11	B
		24VAC	3TX7111-3HC13C	3TX7111-3PC13	3TX7111-5PC13B	4E5	1L11	B
		120 VAC	3TX7111-3HF13C	3TX7111-3PF13	3TX7111-5PF13B	4E5	1L11	B
		240 VAC	—	3TX7111-3PG13	—	4E5	1L11	B
4PDT	15	24VDC	3TX7117-5HC03C	3TX7117-5PC03	—	4E9	1L10	A
		24VAC	3TX7117-5HC13C	3TX7117-5PC13	—	4E9	1L10	A
		120 VAC	3TX7117-5HF13C	3TX7117-5PF13	—	4E9	1L10	A

Option	Basic	Premium	Premium Bifurcated
Mechanical Flag	✓	✓	✓
Push To Test		✓	✓
Lock Down Door		✓	✓
LED		✓	✓

Note: See page 11/139 for socket accessories.

Function Relays, Interfaces and Converters

Coupling Relays and Interfaces

3TX71 plug-in relays

Selection and ordering data



Standard Octal Base

Contacts	Contact Rating (A)	Coil Voltage	Basic Relay	Premium Relay	Uses Socket 3TX7144-	Uses Clip 3TX7144-	Socket Access Set
DPDT	10	12 VDC	3TX7112-1DB03C	3TX7112-1LB03	4E2	1L14	A
		24VDC	3TX7112-1DC03C	3TX7112-1LC03	4E2	1L14	A
		24VAC	3TX7112-1DC13C	3TX7112-1LC13	4E2	1L14	A
		120 VAC	3TX7112-1DF13C	3TX7112-1LF13	4E2	1L14	A
		240 VAC	3TX7112-1DG13C	3TX7112-1LG13	4E2	1L14	A
3PDT	10	24VDC	3TX7112-1FC03C	3TX7112-1NC03	4E3	1L14	A
		24VAC	3TX7112-1FC13C	3TX7112-1NC13	4E3	1L14	A
		120 VAC	3TX7112-1FF13C	3TX7112-1NF13	4E3	1L14	A
		240 VAC	—	3TX7112-1NG13	4E3	1L14	A



Hermetically Sealed

Contacts	Contact Rating (A)	Coil Voltage	Basic Relay	Uses Socket 3TX7144-	Uses Clip 3TX7144-	Socket Access Set
DPDT	12	24 VDC	3TX7127-5HC00	4E2	1L12	A
4PDT	3	24VDC	3TX7127-3HC00	4E5	1L11	B
		24VAC	3TX7127-3HC10	4E5	1L11	B
		120 VAC	3TX7127-3HF10	4E5	1L11	B
4PDT	5	12 VDC	3TX7127-3HB03	4E5	1L11	B
		24VDC	3TX7127-3HC03	4E5	1L11	B
		120 VAC	3TX7127-3HF13	4E5	1L11	B

Socket Accessories

Access. Series	MOV	MOV	R/C	R/C	Diode
	24VAC/DC	120VAC/DC	6-24VAC/DC	110-240VAC/DC	6-250VDC
A	3TX7144-H1	3TX7144-H20	3TX7144-H4	3TX7144-H5	3TX7144-H6
B	3TX7144-H9	3TX7144-H17	—	—	3TX7144-H12

Note: See socket accessories above.

Selection and ordering data

Open Power Relays

Contacts	Contact Rating (A)	Coil Voltage	Basic Relay	Metal Cover 7144-
SPST NO-DM	40	24VAC	3TX7130-0AC13	1M0
SPST NO-DM		120 VAC	3TX7130-0AF13	1M0
SPST NO-DM		240 VAC	3TX7130-0AH13	1M0
SPST NC-DM	40	120 VAC	3TX7130-0QF13	1M0
SPDT		24 VAC	3TX7130-0BC13	1M0
SPDT		120 VAC	3TX7130-0BF13	1M0
SPDT		240 VAC	3TX7130-0BH13	1M0
SPDT	40	277 VAC	3TX7130-0BS13	1M0
DPDT		24 VAC	3TX7130-0DC13	1M0
		120 VAC	3TX7130-0DF13	1M0
		240 VAC	3TX7130-0DH13	1M0
		277 VAC	3TX7130-0DS13	1M0
		12 VDC	3TX7130-0DB03	1M0
		24 VDC	3TX7130-0DC03	1M0
	48 VDC	3TX7130-0DD03	1M0	
DPST NO	40	110 VDC	3TX7130-0DF03	1M0
		24 VAC	3TX7130-0CC13	1M0
		120 VAC	3TX7130-0CF13	1M0
		240 VAC	3TX7130-0CH13	1M0
		12 VDC	3TX7130-0CB03	1M0
DPDT (Mag Blowout)	40	24 VDC	3TX7130-0CC03	1M0
		48 VDC	3TX7130-0CD03	1M0
		120 VAC	3TX7130-0RF13	1M0
		12 VDC	3TX7130-0RB03	1M0
		24 VDC	3TX7130-0RC03	1M0
		48 VDC	3TX7130-0RD03	1M0
		110 VDC	3TX7130-0RF03	1M0



Enclosed Power Relays

Contacts	Contact Rating (A)	Coil Voltage	Basic Relay
DPST-NO	30	24VAC	3TX7131-4CC13
		120 VAC	3TX7131-4CF13
		230 VAC	3TX7131-4CH13
DPDT	30 NO/ 3 NC	12 VDC	3TX7131-4DB03
		24 VDC	3TX7131-4DC03
		24VAC	3TX7131-4DC13
		120 VAC	3TX7131-4DF13
		230 VAC	3TX7131-4DH13



Note: See page 11/139 for socket accessories.

Function Relays, Interfaces and Converters

Coupling Relays and Interfaces

3TX71 plug-in relays

General specifications

Contact Characteristics		Units	3TX7110		3TX7111			
Number and Type of Contacts			SPDT	SPDT	DPDT	DPDT	4PDT	4PDT
Contact Material			Silver Alloy	Silver Alloy	Silver Alloy	Silver Alloy	Silver Alloy	Silver Alloy
Thermal (Carrying) Current	A	15	3 (Bifurcated)	12	3 (Bifurcated)	6	3 (Bifurcated)	3 (Bifurcated)
Maximum Switching Voltage	V	300	300	300	300	300	300	300
Switching Current at Voltage	Resistive	15A @240V	3A @240V	—	3A @240V	6A @240V	3A @240V	3A @240V
	Resistive	15A @120V	—	12A @120V	3A @120V	6A @120V	3A @120V	3A @120V
	Resistive	15A @ 28	—	12A @ 28	3A @ 30	6A @ 28	3A @ 30	3A @ 30
	HP	1/2 @ 120VAC	—	1/3 @ 120VAC	1/16 @ 120VAC	1/3 @ 120VAC	1/16 @ 120VAC	1/16 @ 120VAC
	HP	1 @ 240VAC	—	—	—	1 @ 240VAC	—	—
Pilot Duty		B300	—	B300	—	B300	—	—
Minimum Switching Requirement	mA	100 @ 5VDC (.5W)	3 @ 17VDC (.4W)	100 @ 5VDC (.5W)	3 @ 17VDC (.4W)	100 @ 5VDC (.5W)	3 @ 17VDC (.4W)	3 @ 17VDC (.4W)
Coil Characteristics								
Voltage Range	AC	V	6...240	6...240	6...240	6...240	6...240	6...240
	DC	V	6...125	6...125	6...125	6...125	6...125	6...125
Operating Range	AC	%	85 to 110	85 to 110	85 to 110	85 to 110	85 to 110	85 to 110
	DC	%	80 to 110	80 to 110	80 to 110	80 to 110	80 to 110	80 to 110
Average Consumption	AC	VA	0.9	0.9	1.2	1.2	1.2	1.2
	DC	W	0.7	0.7	0.9	0.9	0.9	0.9
Drop-out Voltage Threshold	AC	%	15	15	15	15	15	15
	DC	%	10	10	10	10	10	10
Performance Characteristics								
Electrical Life (UL508)	Operations @ Rated Current	(Resistive)	100,000	100,000	200,000	200,000	200,000	200,000
Mechanical Life	Unpowered		10,000,000	10,000,000	10,000,000	10,000,000	10,000,000	10,000,000
Operating Time (response time)		ms	20	20	20	20	20	20
Dielectric Strength	Between Coil and Contact	V(rms)	2500	2500	2500	2500	2500	2500
	Between Poles	V(rms)	1500	1500	1500	1500	1500	1500
	Between Contacts	V(rms)	1500	1500	1500	1500	1500	1500
Environment								
Product Certifications	Standard Version		UL,RoHS	UL,RoHS	UL,RoHS	UL,RoHS	UL,RoHS	UL,RoHS
Ambient Air Temperature around the Device	Storage	°C	-40...+85	-40...+85	-40...+85	-40...+85	-40...+85	-40...+85
	Operational	°C	-40...+55	-40...+55	-40...+55	-40...+55	-40...+55	-40...+55
Vibration Resistance	Operational	g-n	3, 10 - 55 Hz	3, 10 - 55 Hz	3, 10 - 55 Hz	3, 10 - 55 Hz	3, 10 - 55 Hz	3, 10 - 55 Hz
Shock Resistance		g-n	10	10	10	10	10	10
Degree of Protection			IP40	IP40	IP40	IP40	IP40	IP40
Weight		grams	29	29	36	36	36	36

Contact Characteristics		Units	3TX7112	3TX7114	3TX7115	3TX7116	3TX7117	
Number and Type of Contacts			DPDT	3PDT	DPDT	DPDT	3PDT	4PDT
Contact Material			Silver Alloy	Silver Alloy	Silver Alloy	Silver Alloy	Silver Alloy	Silver Alloy
Thermal (Carrying) Current	A	10	10	15	10	10	15	15
Maximum Switching Voltage	V	300	300	300	300	300	300	300
Switching Current at Voltage	Resistive	10A @240V	10A @240V	12A @277V	10A @277V	10A @277V	12A @277V	12A @277V
	Resistive	10A @120V	10A @120V	15A @120V	10A @120V	10A @120V	15A @120V	15A @120V
	Resistive	10A @ 28	10A @ 28	12A @ 28	10A @ 28	10A @ 28	12A @ 28	12A @ 28
	HP	1/3 @ 120VAC	1/3 @ 120VAC	1/2 @ 120VAC	1/3 @ 120VAC	1/3 @ 120VAC	1/2 @ 120VAC	1/2 @ 120VAC
	HP	1/2 @ 240VAC	1/2 @ 240VAC	1 @ 240VAC	1/2 @ 240VAC	1/2 @ 240VAC	3/4 @ 240VAC	3/4 @ 240VAC
Pilot Duty		B300	B300	B300	B300	B300	B300	B300
Minimum Switching Requirement	mA	100 @ 5VDC (.5W)	100 @ 5VDC (.5W)	100 @ 5VDC (.5W)	100 @ 5VDC (.5W)	100 @ 5VDC (.5W)	100 @ 5VDC (.5W)	100 @ 5VDC (.5W)
Coil Characteristics								
Voltage Range	AC	V	6...240	6...240	6...240	6...240	6...240	6...240
	DC	V	6...125	6...125	6...125	6...125	6...125	6...125
Operating Range	AC	%	85 to 110	85 to 110	85 to 110	85 to 110	85 to 110	85 to 110
	DC	%	80 to 110	80 to 110	80 to 110	80 to 110	80 to 110	80 to 110
Average Consumption	AC	VA	1.2	1.2	1.2	1.2	1.5	1.5
	DC	W	0.9	0.9	0.9	0.9	1.4	1.5
Drop-out Voltage Threshold	AC	%	15	15	15	15	15	15
	DC	%	10	10	10	10	10	10
Performance Characteristics								
Electrical Life (UL508)	Operations @ Rated Current	(Resistive)	200,000	200,000	100,000	100,000	100,000	200,000
Mechanical Life	Unpowered		10,000,000	10,000,000	10,000,000	10,000,000	10,000,000	10,000,000
Operating Time (response time)		ms	20	20	20	20	20	20
Dielectric Strength	Between Coil and Contact	V(rms)	2500	2500	2500	2500	2500	2500
	Between Poles	V(rms)	1500	1500	1500	1500	2500	2500
	Between Contacts	V(rms)	1500	1500	1500	1500	1500	2500
Environment								
Product Certifications	Standard Version		UL,RoHS	UL,RoHS	UL,RoHS	UL,RoHS	UL,RoHS	UL,RoHS
Ambient Air Temperature around the Device	Storage	°C	-40...+85	-40...+85	-40...+85	-40...+85	-40...+85	-40...+85
	Operational	°C	-40...+55	-40...+55	-40...+55	-40...+55	-40...+55	-40...+55
Vibration Resistance	Operational	g-n	3, 10 - 55 Hz	3, 10 - 55 Hz	3, 10 - 55 Hz	3, 10 - 55 Hz	3, 10 - 55 Hz	3, 10 - 55 Hz
Shock Resistance		g-n	10	10	10	10	10	10
Degree of Protection			IP40	IP40	IP40	IP40	IP40	IP40
Weight		grams	89	89	36	88	88	60

Function Relays, Interfaces and Converters

Coupling Relays and Interfaces

3TX71 plug-in relays

General specifications

Contact Characteristics			Units	3TX7127			3TX7130
Number and Type of Contacts				DPDT	4PDT	4PDT	All
Contact Material				Silver Alloy	Fine Silver	Silver Alloy	Silver Alloy
Thermal (Carrying) Current			A	12	3	5	40
Maximum Switching Voltage			V	300	300	300	600
Switching Current at Voltage			Resistive	12A @240V	3A @240V	12A @240V	40A @277V
			Resistive	12A @120V	3A @120V	—	—
			Resistive	12A @ 28	3A @ 30	—	40A @ 28
			HP	1/3 @ 120VAC	1/16 @ 120VAC	—	—
			HP	1/2 @ 240VAC	1/10 @ 240VAC	—	—
Pilot Duty				B300	—	—	—
Minimum Switching Requirement			mA	100 @ 5VDC (.5W)	10 @ 5VDC (.5W)	100 @ 5VDC (.5W)	1000 @ 12VAC/DC
Coil Characteristics							
Voltage Range		AC	V	6...240	6...240	6...240	6...600
		DC	V	6...125	6...125	6...125	6...600
Operating Range		AC	%	85 to 110	85 to 110	85 to 110	85 to 110
		DC	%	80 to 110	80 to 110	80 to 110	80 to 110
Average Consumption		AC	VA	1.2	1.2	1.2	10
		DC	W	0.9	0.9	0.9	4
Drop-out Voltage Threshold		AC	%	15	15	15	10
		DC	%	10	10	10	10
Performance Characteristics							
Electrical Life (UL508)		Operations @ Rated Current	(Resistive)	100,000	100,000	100,000	100,000
Mechanical Life		Unpowered		10,000,000	10,000,000	10,000,000	1,000,000
Operating Time (response time)			ms	20	20	20	30
Dielectric Strength		Between Coil and Contact	V(rms)	1,500	1240	1240	2200
		Between Poles	V(rms)	1,500	1240	1240	2200
		Between Contacts	V(rms)	1500	500	500	1500
Environment							
Product Certifications		Standard Version		UL,RoHS	UL,RoHS	UL,RoHS	UL
Ambient Air Temperature around the Device		Storage	°C	-40...+85	-40...+85	-40...+85	-40...+85
		Operational	°C	-40...+55	-40...+70	-40...+70	-40...+70
Vibration Resistance		Operational	g-n	3, 10 - 55 Hz	3, 10 - 55 Hz	3, 10 - 55 Hz	3, 10 - 55 Hz
Shock Resistance			g-n	10	10	10	—
Degree of Protection				IP67	IP67	IP67	Open
Weight			grams	130	45	45	227 to 312

Contact Characteristics			Units	3TX7131			3TX7132
Number and Type of Contacts				DPST-NO	DPDT	DPDT	SPDT
Contact Material				Silver Alloy	Silver Alloy	Silver Alloy	Silver Alloy
Thermal (Carrying) Current			A	30	30 DPDT-NO	3 DPDT-NC	30 SPDT-NO
Maximum Switching Voltage			V	600	300	300	300
Switching Current at Voltage			Resistive	20A @300V	30A @277V	3A @277V	30A @277V
			Resistive	—	—	—	—
			Resistive	20A @ 28	20A @ 28	3A @ 28	10A @ 28
			HP	1/3 @ 120VAC	1 @ 120VAC	—	1 @ 120VAC
			HP	1/2 @ 600VAC	3 @ 240VAC	—	2 @ 240VAC
Pilot Duty				—	—	—	—
Minimum Switching Requirement			mA	500 @ 12VAC/DC	500 @ 12VAC/DC	500 @ 12VAC/DC	1000 @ 12VAC/5VDC
Coil Characteristics							
Voltage Range		AC	V	12...240	12...240	12...240	12...277
		DC	V	6...110	6...110	6...110	5...110
Operating Range		AC	%	85 to 120	85 to 120	85 to 120	85 to 120
		DC	%	75 to 120	75 to 120	75 to 120	75 to 120
Average Consumption		AC	VA	4	4	4	2.8
		DC	W	1.7	1.7	1.7	1
Drop-out Voltage Threshold		AC	%	10	10	10	10
		DC	%	10	10	10	10
Performance Characteristics							
Electrical Life (UL508)		Operations @ Rated Current	(Resistive)	100,000	100,000	100,000	100,000
Mechanical Life		Unpowered		5,000,000	5,000,000	5,000,000	10,000,000
Operating Time (response time)			ms	15	15	15	15
Dielectric Strength		Between Coil and Contact	V(rms)	4000	4000	4000	2500
		Between Poles	V(rms)	2000	2000	2000	1500
		Between Contacts	V(rms)	1500	1500	1500	1500
Environment							
Product Certifications		Standard Version		UL	UL	UL	UL
Ambient Air Temperature around the Device		Storage	°C	-40...+85	-40...+85	-40...+85	-40...+85
		Operational	°C	-40...+55	-40...+55	-40...+55	-40...+55
Vibration Resistance		Operational	g-n	3, 10 - 55 Hz	3, 10 - 55 Hz	3, 10 - 55 Hz	3, 10 - 55 Hz
Shock Resistance			g-n	10	10	10	10
Degree of Protection				—	—	—	—
Weight			grams	86	86	86	33

Function Relays, Interfaces and Converters

Coupling Relays and Interfaces

3TX71 plug-in relays

Circuit diagrams

3TX7110

SPDT

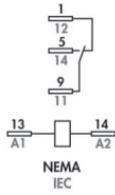

3TX7111

DPDT

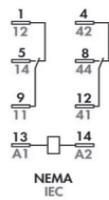

3TX7111

4PDT

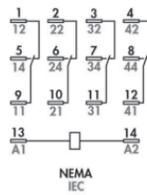

3TX7112

DPDT

AC COIL CIRCUIT

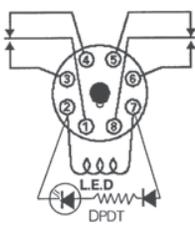

3TX7112

3PDT

AC COIL CIRCUIT

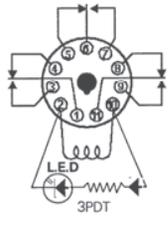

3TX7112-1L, -1D

DPDT

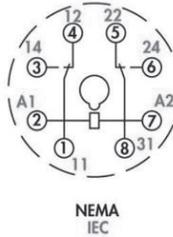

3TX7112-1N, -1F

3PDT

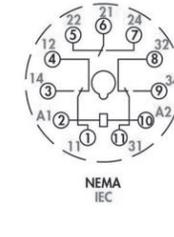

DC COIL CIRCUIT

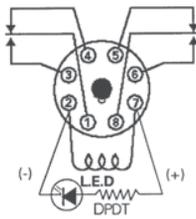

DC COIL CIRCUIT

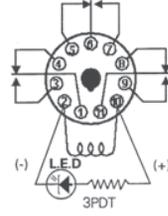

3TX7114

DPDT

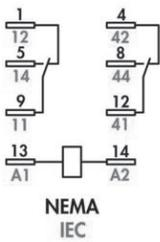

3TX7115

DPDT

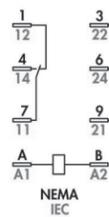

3TX7115

3PDT

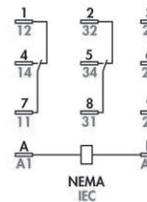

Function Relays, Interfaces and Converters

Coupling Relays and Interfaces

3TX71 plug-in

Circuit diagrams

3TX7116

3PDT

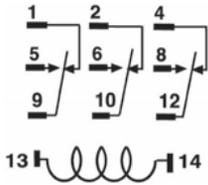

3TX7117

4PDT

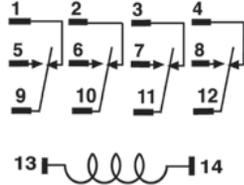

3TX7127

4PDT

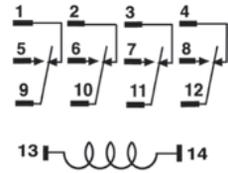

3TX7127 (DPDT)

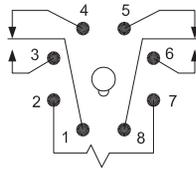

3TX7127 (3PDT)

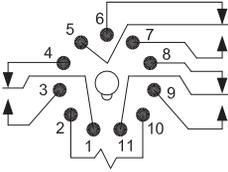

3TX7130

SPST-NO



3TX7130

SPDT

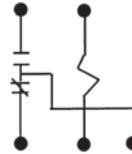

3TX7130

DPST-NO

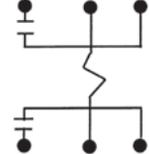

3TX7130

SPST-NC



3TX7130

DPDT

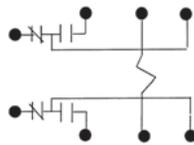

3TX7130 (DPDT)

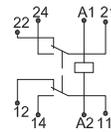

3TX7131 (DPST-NO) (AC)

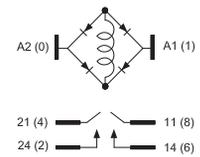

Function Relays, Interfaces and Converters

Coupling Relays and Interfaces

3TX71 plug-in relays

Circuit diagrams

3TX7131 (DPST-NO) (DC)

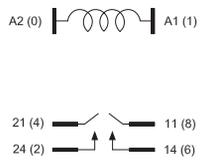

3TX7131 (DPDT) (AC)

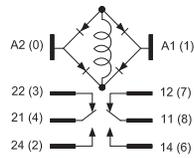

3TX7131 (DPDT) (DC)

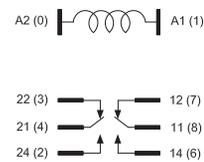

Function Relays, Interfaces and Converters

Coupling Relays and Interfaces

3TX71 plug-in relays

Dimension drawings

3TX7110 SPDT

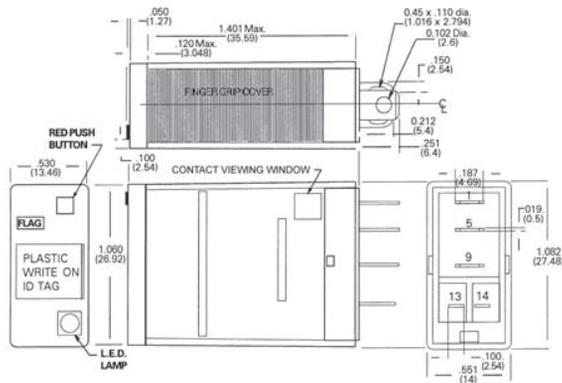

3TX7111 DPDT

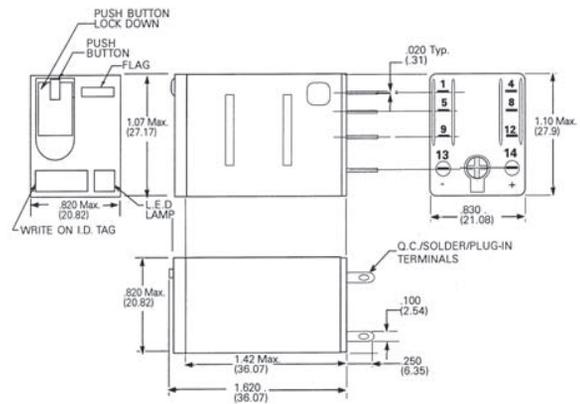

3TX7111 4PDT

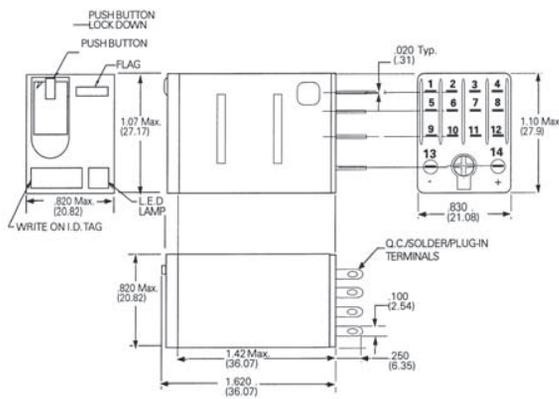

3TX7112 DPDT

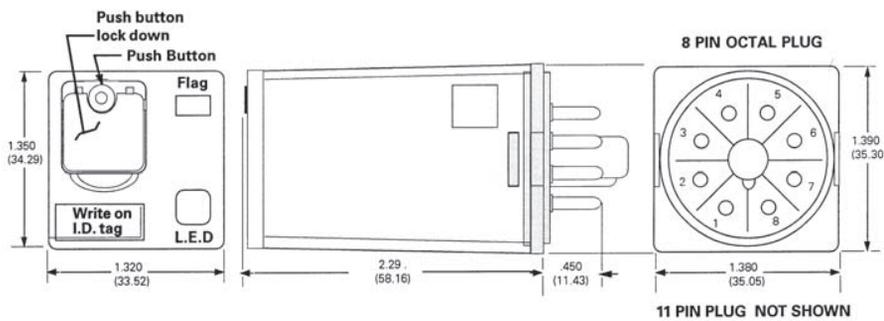

Function Relays, Interfaces and Converters

Coupling Relays and Interfaces

3TX71 plug-in relays

Dimension drawings

3TX7114 DPDT

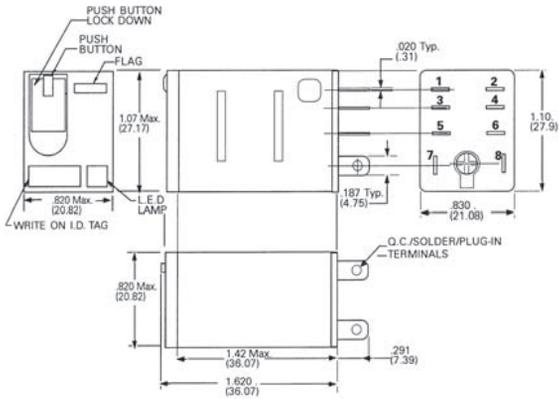

3TX7115 (DPDT) (clear cover)

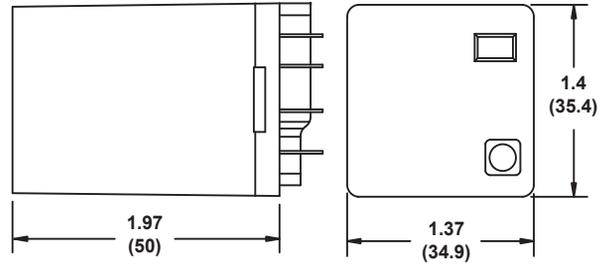

3TX7115 (DPDT) (full feature)

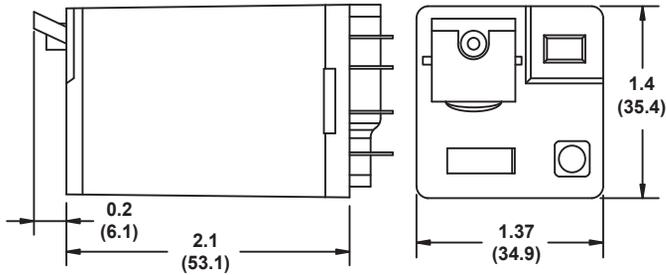

3TX7115 3PDT

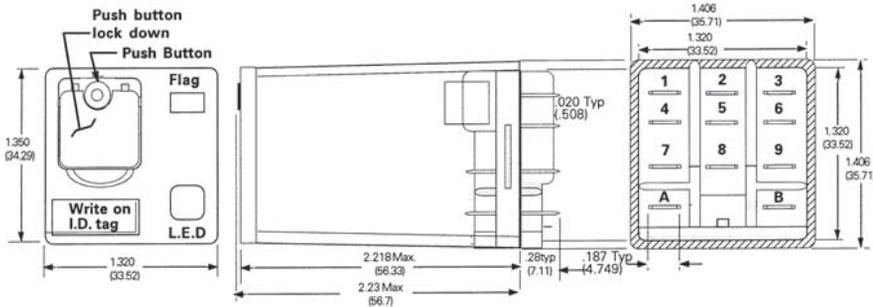

3TX7116 3PDT

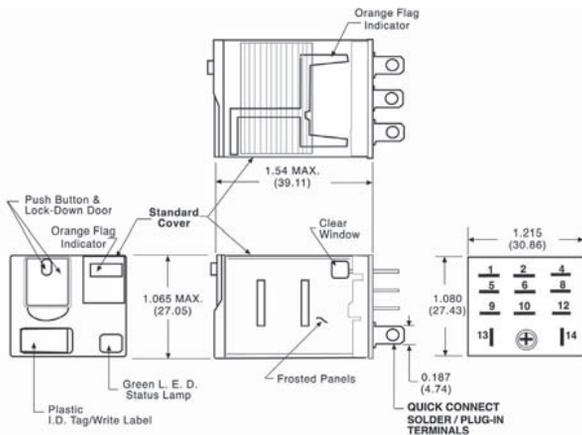

3TX7117 4PDT

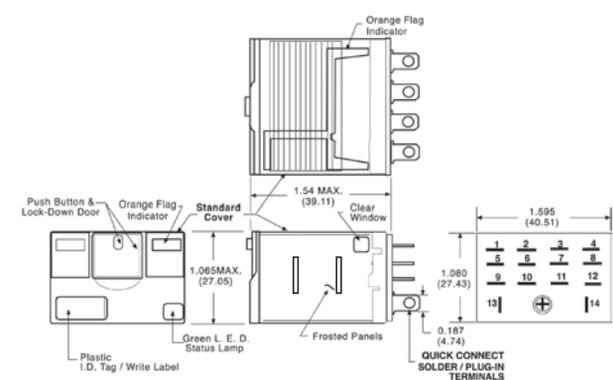

Function Relays, Interfaces and Converters

Coupling Relays and Interfaces

3TX71 plug-in relays

Dimension drawings

3TX7127 (DPDT)

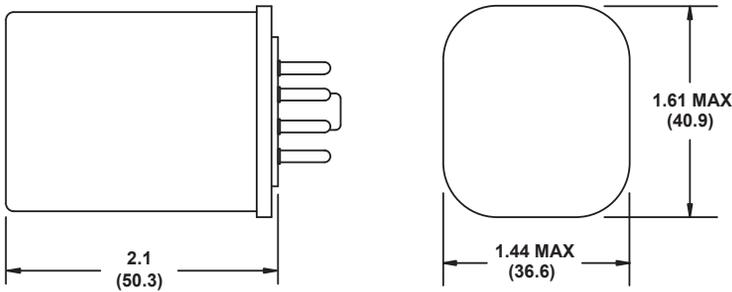

3TX7127 3PDT

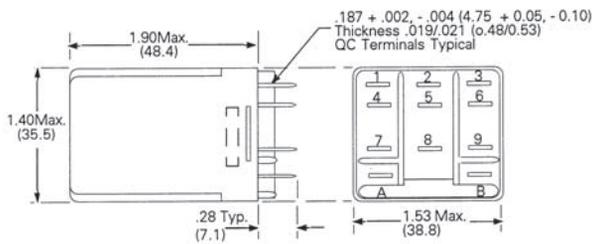

3TX7127 4PDT

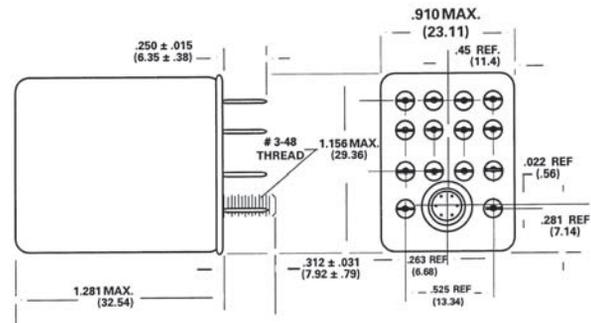

3TX7130 SPST NC

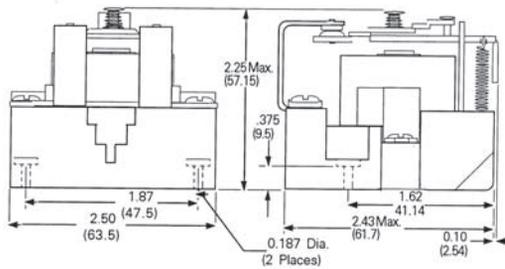

3TX7130 SPST NO

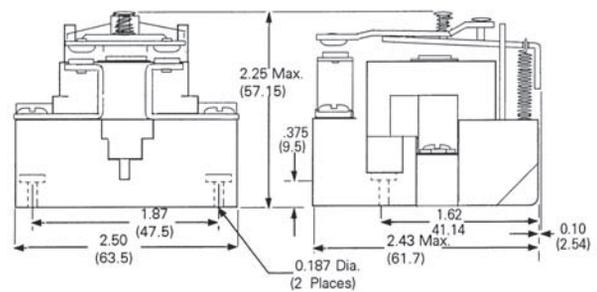

Function Relays, Interfaces and Converters

Coupling Relays and Interfaces

3TX71 plug-in relays

Dimension drawings

3TX7130 SPDT

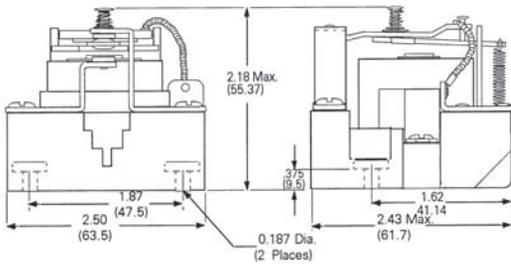

3TX7130 DPST NO

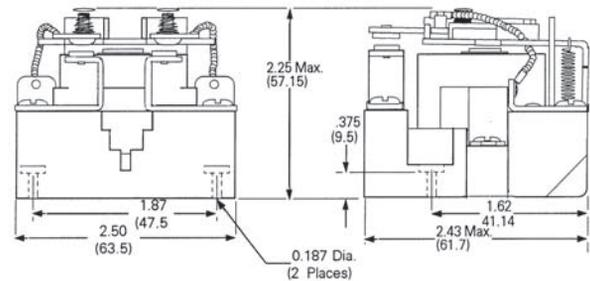

3TX7130 DPDT

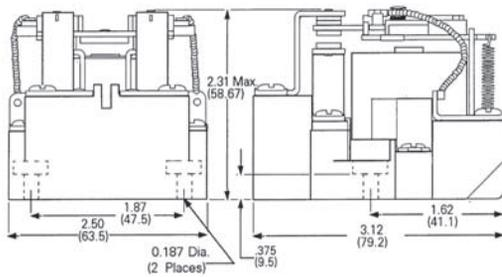

3TX7130 DPDT with magnetic blowout

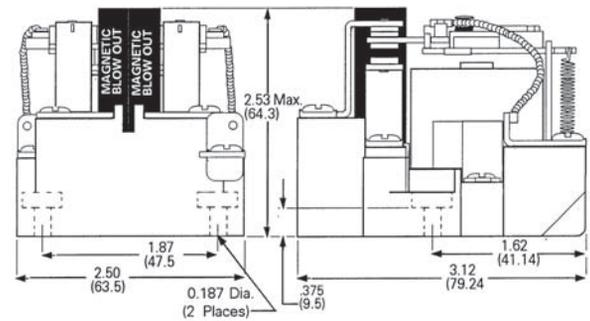

3TX7131 (DPST-NO)

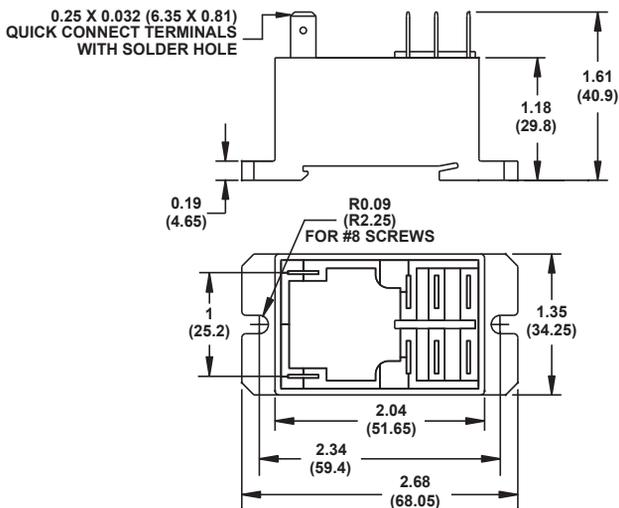

3TX7131 (DPDT)

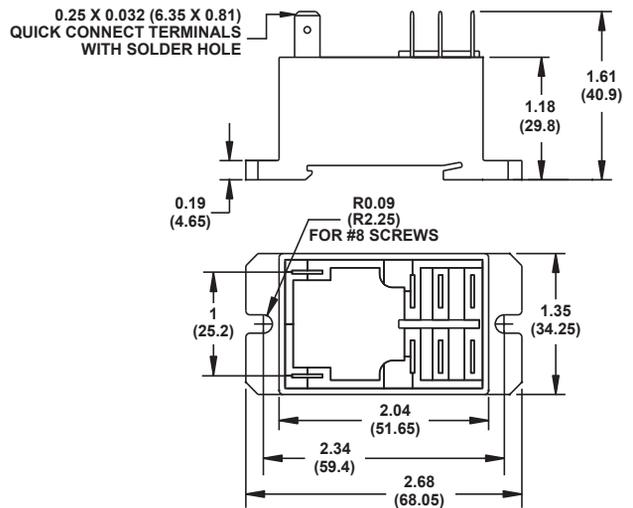

Function Relays, Interfaces and Converters

Coupling Relays and Interfaces

3TX71 plug-in relays

Dimension drawings

3TX7144-4E4

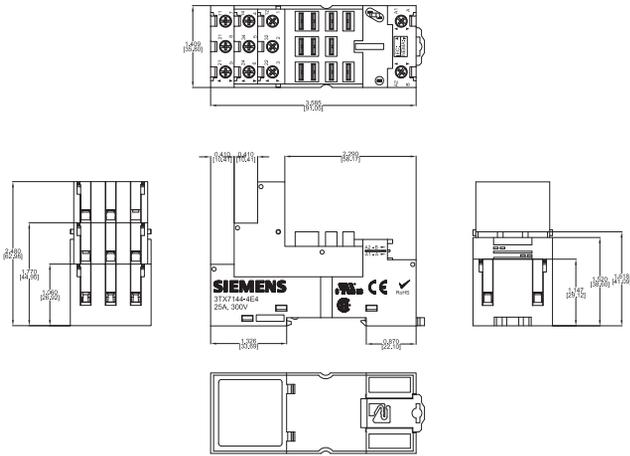

3TX7144-4E5

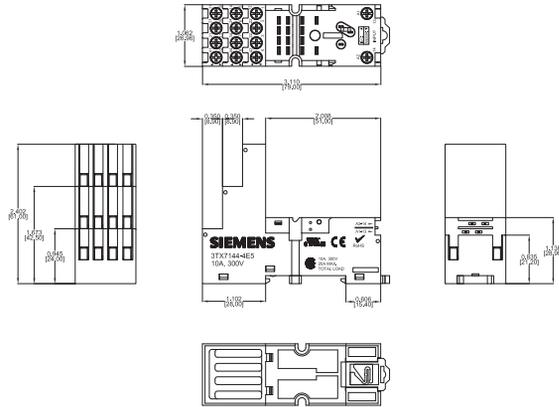

3TX7144-4E6

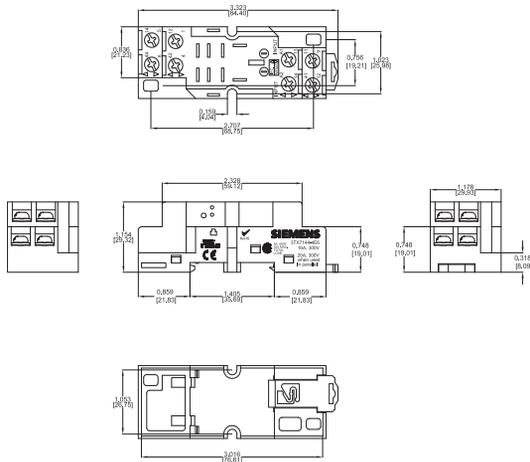

3TX7144-4E7

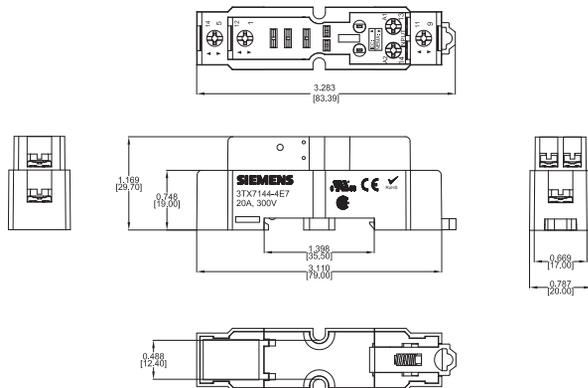

3TX7144-4E8

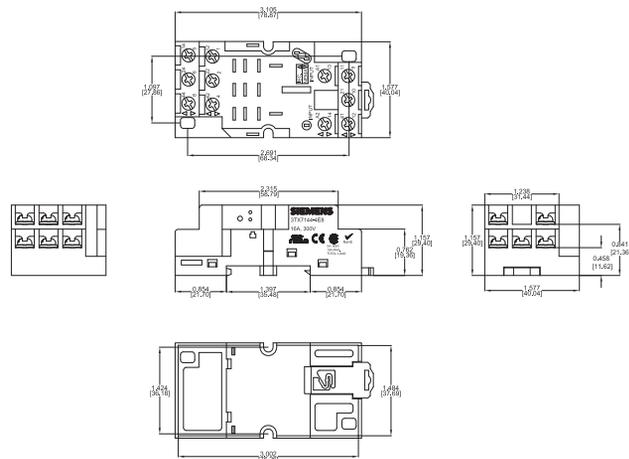

3TX7144-4E9

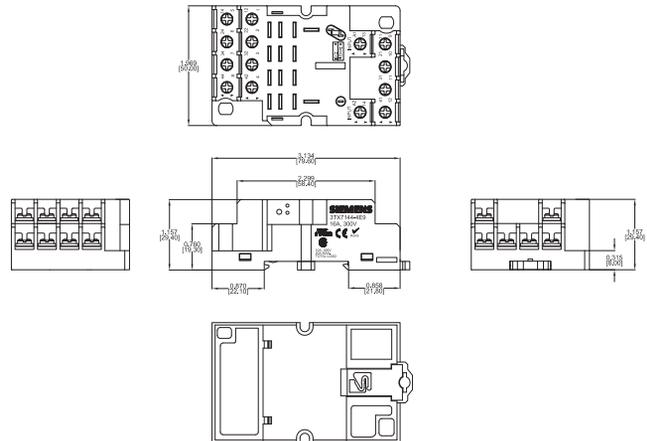

Selection and ordering data

Version	Rated control supply voltage U_s (at AC: 50/60 Hz)	Contacts, number of CO contacts	Width mm	SD d	Article No.	Price per PU	PU (UNIT, SET, M)	PS*
---------	--	---------------------------------	----------	------	-------------	--------------	-------------------	-----

Complete units, 3CO and 4CO contacts, PT series



LZS:PT3A5L24

Complete units with plug-in base					Screw terminals 			
For snap-on mounting onto DINrail Comprising:								
<ul style="list-style-type: none"> • Plug-in relays • Standard plug-in base with screw terminals • LED module (24 V DC version: LED module with freewheel diode) • Fixing/ejection brackets • Labels 								
3 CO contacts	24 DC	3	28	2	LZS:PT3A5L24		1	5 units
	24 AC				LZS:PT3A5R24			
	115 AC				LZS:PT3A5S15			
	230 AC				LZS:PT3A5T30			
4 CO contacts	24 DC	4	28	2	LZS:PT5A5L24		1	5 units
	24 AC				LZS:PT5A5R24			
	115 AC				LZS:PT5A5S15			
	230 AC				LZS:PT5A5T30			

Complete units with plug-in base With logical separation								
For snap-on mounting onto DIN rail Comprising:								
<ul style="list-style-type: none"> • Plug-in relays • Plug-in base with logical separation and screw terminals • LED module (24 V DC version: LED module with freewheel diode) • Fixing/ejection brackets • Labels 								
4 CO contacts	24 DC	4	28	2	LZS:PT5B5L24		1	5 units
	24 AC				LZS:PT5B5R24			
	115 AC				LZS:PT5B5S15			
	230 AC				LZS:PT5B5T30			

Complete units, 2CO and 4CO contacts, PT series



LZS:PT5D5L24

Complete units with plug-in base With logical separation					Push-in terminals 			
For snap-on mounting onto DIN rail Comprising:								
<ul style="list-style-type: none"> • Plug-in relays • Plug-in base with logical separation and push-in terminals • LED module (24 V DC version: LED module with freewheel diode) • Fixing/ejection brackets • Labels 								
2 CO contacts	24 DC	2	28	2	LZS:PT2D5L24		1	5 units
	230 AC				LZS:PT2D5T30			
4 CO contacts	24 DC	4	28	2	LZS:PT5D5L24		1	5 units
	24 AC				LZS:PT5D5R24			
	115 AC				LZS:PT5D5S15			
	230 AC				LZS:PT5D5T30			

Note:

Logical separation: The terminals for the contacts and the terminals for the coil are arranged on separate levels, e.g. above for contacts and below for the coil. Logical separation is not necessarily protective separation.

Protective separation: Protective separation prevents voltage of one circuit affecting another circuit with sufficient protection (IEC 61140).

Version	Rated control supply voltage U_s at 50/60 Hz AC	Contacts, number of CO contacts	Width	SD	Article No.	Price per PU	PU (UNIT, SET, M)	PS*
	V		mm	d				

Individual modules for customer assembly, PT series



LZX:PT370024

Mini industrial relays

- With push-to-test and mechanical flag, without LED¹⁾

24 DC	2	22.5	▶	LZX:PT270024	1	1 unit
	3			LZX:PT370024		
	4			LZX:PT570024		
24 AC	2	22.5	▶	LZX:PT270524	1	1 unit
	3			LZX:PT370524		
	4			LZX:PT570524		
115 AC	2	22.5	▶	LZX:PT270615	1	1 unit
	3			LZX:PT370615		
	4			LZX:PT570615		
230 AC	2	22.5	▶	LZX:PT270730	1	1 unit
	3			LZX:PT370730		
	4			LZX:PT570730		

- With hard gold-plating

24 DC 230 AC	4	22.5	▶	LZX:PT580024	1	1 unit
				LZX:PT580730		

- Without push-to-test

24 DC 230 AC	4	22.5	▶	LZX:PT520024	1	1 unit
				LZX:PT520730		

Plug-in bases for PT relays

Standard plug-in bases
For mounting onto DIN rail



LZS:PT78740

				Screw terminals 		
--	2	28	▶	LZS:PT78720	1	1 unit
	3			LZS:PT78730		
	4			LZS:PT78740		

Plug-in bases with logical separation

For mounting onto DIN rail



LZS:PT78722

--	2	28	▶	LZS:PT78722	1	1 unit
	4			LZS:PT78742		

Plug-in bases with logical separation

For mounting onto DIN rail



LZS:PT7874P

				Push-in terminals 		
--	2	28	▶	LZS:PT7872P	1	1 unit
	4			LZS:PT7874P		

¹⁾ The push-to-test is designed to be non-latching. If the push-to-test is pressed further until 90° has been reached, two small lugs break off and the push-to-test can be latched in position.

Note:

Logical separation: The terminals for the contacts and the terminals for the coil are arranged on separate levels, e.g. above for contacts and below for the coil. Logical separation is not necessarily protective separation.

Protective separation: Protective separation prevents voltage of one circuit affecting another circuit with sufficient protection (IEC 61140).

Version	Rated control supply voltage U_c at 50/60 Hz AC	Contacts, number of CO contacts	Width	SD	Article No.	Price per PU	PU (UNIT, SET, M)	PS*
	V		mm	d				

Individual modules for customer assembly, PT series

More individual modules								
LED modules								
• Red								
LZS:PTML0024	- With freewheel diode	24 DC	--	12.5	▶	LZS:PTML0024	1	1 unit
	- Without freewheel diode	24 AC/DC	--	12.5	▶	LZS:PTML0524	1	1 unit
		110 ... 230 AC/DC	--	12.5	▶	LZS:PTML0730	1	1 unit
• Green								
LZS:PTMG0024	- With freewheel diode	24 DC	--	12.5	▶	LZS:PTMG0024	1	1 unit
	- Without freewheel diode	24 AC/DC	--	12.5	▶	LZS:PTMG0524	1	1 unit
		110 ... 230 AC/DC	--	12.5	▶	LZS:PTMG0730	1	1 unit
Fixing/ejection brackets for PT base with logical separation								
LZS:PT17021	Screw terminals and plug-in terminals (push-in)	--	--	26	▶	LZS:PT17021	100	10 units
Fixing/ejection brackets for standard plug-in base without logical separation								
LZS:PT17024	Screw terminals	--	--	26	▶	LZS:PT17024	100	10 units
Labels								
LZS:PT17040		--	--	26	▶	LZS:PT17040	100	10 units
RC elements								
LZS:PTMU0524	6 ... 60 AC	--	--	26	▶	LZS:PTMU0524	1	1 unit
	110 ... 230 AC	--	--	26	▶	LZS:PTMU0730	1	1 unit
Freewheel diodes with connection to A1								
LZS:PTMT00A0	6 ... 230 DC	--	--	26	▶	LZS:PTMT00A0	1	1 unit
Connecting cables, 24-pole								
LZS:PTMU0730	Current carrying capacity 12 A, with supply cable, blue	--	--	--	2	3TX7004-8BA00	1	1 unit
Connecting combs for PT screw base								
3TX7004-8BA00	6-pole, 10 A current carrying capacity, natural-colored	--	--	--	5	LZS:PT170R6	1	10 units
		--	--	--	5	LZS:PT170R6	1	10 units
Connecting brackets for PT push-in base								
	2-pole, 10 A current carrying capacity, natural-colored	--	--	--	5	LZS:PT170P1	1	10 units

Individual modules for customer assembly, MT series, octal base

Industrial relays, 3CO								
Industrial relays with push-to-test								
LZX:MT326024	Without LED	24 DC	3	35.5	2	LZX:MT321024	1	1 unit
	With LED	24 DC	3	35.5	2	LZX:MT323024	1	1 unit
	Without LED	24 AC	3	35.5	2	LZX:MT326024	1	1 unit
	With LED	24 AC	3	35.5	15	LZX:MT328024	1	1 unit
	Without LED	115 AC	3	35.5	15	LZX:MT326115	1	1 unit
	With LED	115 AC	3	35.5	15	LZX:MT328115	1	1 unit
	Without LED	230 AC	3	35.5	2	LZX:MT326230	1	1 unit
	With LED	230 AC	3	35.5	2	LZX:MT328230	1	1 unit
Plug-in bases								
LZS:MT78750	For mounting onto DIN rail	--	--	38	▶	Screw terminals 		
		--	--	38	▶	LZS:MT78750	1	1 unit
Fixing brackets								
		--	--	38	▶	LZS:MT28800	1	1 unit

Note:

Logical separation: The terminals for the contacts and the terminals for the coil are arranged on separate levels, e.g. above for contacts and below for the coil. Logical separation is not necessarily protective separation.

Protective separation: Protective separation prevents voltage of one circuit affecting another circuit with sufficient protection (IEC 61140).

Version	Rated control supply voltage U_s at 50/60 Hz AC	Contacts, number of CO contacts	Width mm	SD d	Article No.	Price per PU	PU (UNIT, SET, M)	PS*	
Complete units, 1CO and 2CO, 5 mm pinning, RT series									
 LZS:RT4A4T30	Complete units with standard plug-in base For snap-on mounting onto DIN rail Comprising:				Screw terminals 				
	<ul style="list-style-type: none"> • Plug-in relays • Standard plug-in base with screw terminals • LED module (24 V DC version: LED module with freewheel diode) • Fixing/ejection brackets • Labels 								
	1 CO contact	24 DC 24 AC 115 AC 230 AC	1	15.5	2	LZS:RT3A4L24 LZS:RT3A4R24 LZS:RT3A4S15 LZS:RT3A4T30		1	5 units
					2			1	5 units
					2			1	5 units
					2			1	5 units
	2 CO contacts	24 DC 24 AC 115 AC 230 AC	2	15.5	2	LZS:RT4A4L24 LZS:RT4A4R24 LZS:RT4A4S15 LZS:RT4A4T30		1	5 units
					2			1	5 units
 LZS:RT4B4T30	Complete units with plug-in base With logical separation For snap-on mounting onto DIN rail Comprising:								
	<ul style="list-style-type: none"> • Plug-in relays • Plug-in base with logical separation and screw terminals • LED module (24 V DC version: LED module with freewheel diode) • Fixing/ejection brackets • Labels 								
	1 CO contact	24 DC 24 AC 115 AC 230 AC	1	15.5	2	LZS:RT3B4L24 LZS:RT3B4R24 LZS:RT3B4S15 LZS:RT3B4T30		1	5 units
					2			1	5 units
					2			1	5 units
					2			1	5 units
	2 CO contacts	24 DC 24 AC 115 AC 230 AC	2	15.5	2	LZS:RT4B4L24 LZS:RT4B4R24 LZS:RT4B4S15 LZS:RT4B4T30		1	5 units
					2			1	5 units
 LZS:RT3D4L24	Complete units with plug-in base With logical separation For snap-on mounting onto DIN rail Comprising:				Push-in terminals 				
	<ul style="list-style-type: none"> • Plug-in relays • Plug-in base with logical separation and push-in terminals • LED module (24 V DC version: LED module with freewheel diode) • Fixing/ejection brackets • Labels 								
	1 CO contact	24 DC 24 AC 115 AC 230 AC	1	15.5	2	LZS:RT3D4L24 LZS:RT3D4R24 LZS:RT3D4S15 LZS:RT3D4T30		1	5 units
					2			1	5 units
					2			1	5 units
					2			1	5 units
	2 CO contacts	24 DC 24 AC 115 AC 230 AC	2	15.5	2	LZS:RT4D4L24 LZS:RT4D4R24 LZS:RT4D4S15 LZS:RT4D4T30		1	5 units
					2			1	5 units

Note:

Logical separation: The terminals for the contacts and the terminals for the coil are arranged on separate levels, e.g. above for contacts and below for the coil. Logical separation is not necessarily protective separation.

Protective separation: Protective separation prevents voltage of one circuit affecting another circuit with sufficient protection (IEC 61140).

Version	Rated control supply voltage U_c at 50/60 Hz AC	Contacts, number of CO contacts	Width	SD	Article No.	Price per PU	PU (UNIT, SET, M)	PS*
	V		mm	d				

Individual modules for customer assembly, RT series

Print relays, 1CO and 2CO, 5 mm pinning									
	Print relays With hard gold-plating Version with 1 CO contact	24 DC	1	12.7	▶	LZX:RT315024 LZX:RT315730	1	1 unit	
		230 AC			15		1	1 unit	
	Print relays Version with 1 CO contact	24 DC	1	12.7	▶	LZX:RT314024 LZX:RT314524 LZX:RT314615 LZX:RT314730	1	1 unit	
		24 AC			15		1	1 unit	
		115 AC			15		1	1 unit	
		230 AC			▶		1	1 unit	
							▶	1	1 unit
	Print relays Version with 2 CO contacts	12 DC	2	12.7	5	LZX:RT424012 LZX:RT424024 LZX:RT424524 LZX:RT424615 LZX:RT424730	1	1 unit	
		24 DC			▶		1	1 unit	
		24 AC			▶		1	1 unit	
		115 AC			▶		1	1 unit	
		230 AC			▶		1	1 unit	
	Standard plug-in bases For mounting onto DIN rail	--	--	15.5	▶	Screw terminals 			
							LZX:RT78725	1	1 unit
	Plug-in bases with logical separation For mounting onto DIN rail	--	--	15.5	▶	Push-in terminals 			
							LZX:RT78726	1	1 unit
	Plug-in bases with logical separation For mounting onto DIN rail	--	--	15.5	▶	Push-in terminals 			
							LZX:RT7872P	1	1 unit
	LED modules • Red	With freewheel diode	24 DC	--	▶	LZS:PTML0024 LZS:PTML0524 LZS:PTML0730	1	1 unit	
		Without freewheel diode	24 AC/DC	--	▶		1	1 unit	
			110 ... 230 AC/DC	--	▶		1	1 unit	
	LED modules • Green	With freewheel diode	24 DC	--	▶	LZS:PTMG0024 LZS:PTMG0524 LZS:PTMG0730	1	1 unit	
		Without freewheel diode	24 AC/DC	--	▶		1	1 unit	
			110 ... 230 AC/DC	--	▶		1	1 unit	
	Fixing/ejection brackets for RT base	--	--	15.5	▶	LZS:RT17016	100	10 units	
	Labels	--	--	15.5	▶	LZS:RT17040	100	10 units	
	RC elements	6 ... 60 AC	--	15.5	▶	LZS:PTMU0524 LZS:PTMU0730	1	1 unit	
		110 ... 230 AC			▶		1	1 unit	
	Freewheel diodes with connection to A1	6 ... 230 DC	--	15.5	▶	LZS:PTMT00A0	1	1 unit	
	Connecting cables, 24-pole Current carrying capacity 12 A, with supply cable, blue	--	--	--	2	3TX7004-8BA00	1	1 unit	
	Connecting combs for RT screw base 8-pole, 10 A current carrying capacity, natural-colored	--	--	--	▶	LZS:RT170R8	1	10 units	
	Connecting brackets for push-in base 2-pole, 10 A current carrying capacity, natural-colored	--	--	--	5	LZS:RT170P1	100	10 units	

Technical specifications

More information

Technical specifications, see
<https://support.industry.siemens.com/cs/ww/en/ps/16204/td>

Manuals, see
<https://support.industry.siemens.com/cs/ww/en/ps/16204/man>

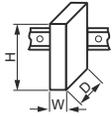
Relay type	LZX:RT print relay, 8-pin, (12.7 mm) 1 CO / 2 CO				LZX:PT industrial relay, 8-, 11- and 14-pin, (22.5 mm) 2 CO / 3 CO / 4 CO					
General data										
Dimensions (W x H x D)										
• LZS:RT.A4 / LZS:PT.A5		mm	15.5 x 78 x 71					28 x 74 x 72		
• LZS:RT.B4 / LZS:PT.B5		mm	15.5 x 77 x 71					28 x 77 x 79		
• LZS:RT.D4 / LZS:PT.D5		mm	15.5 x 98 x 71					28 x 98 x 79		
Rated control supply voltage U_s¹⁾	V		24 DC	24 AC	115 AC	230 AC	24 DC	24 AC	115 AC	230 AC
Rated insulation voltage U_i (Pollution degree 3)	V		250							
Overvoltage category Acc. to IEC 60664-1			III							
Protective separation Between coil and contacts Acc. to IEC 60947-1, Appendix N			Up to 250 V (with plug-in base LZS:RT78726) No (for complete units with standard base)				No			
Degree of protection			IP67				IP50			
• Relays			IP67				IP50			
• Bases			IP20							
Permissible ambient temperature										
• During operation	°C		-40 ... +70							
• During storage	°C		-40 ... +80							
Conductor cross-sections										
Connection type			 Screw terminals							
• Solid	mm ²		2 x 2.5							
• Finely stranded with end sleeve	mm ²		2 x 1.5							
• Corresponding opening tool			Screwdriver, size 3.0 ... 3.5 mm x 0.5 mm (3RA2908-1A)							
Connection type			 Push-in terminals							
• Solid	mm ²		1 x (0.75 ... 1.5), 2 x (0.75 ... 1.0), 2 x 1.5							
• Finely stranded without end sleeve	mm ²		1 x (0.75 ... 1.5), 2 x (0.75 ... 1.0), 2 x 1.5							
• Finely stranded with end sleeve	mm ²		1 x (0.75 ... 1.0), 2 x 0.75, 1 x 1.5							

¹⁾ AC voltages, 50 Hz; for 60 Hz operation, the lower response value must be increased by 10%; the power loss will decrease slightly.

Relay type		LZX:RT print relay, 8-pin, (12.7 mm) 1 CO / 2 CO				LZX:PT industrial relay, 8-, 11- and 14-pin, (22.5 mm) 2 CO / 3 CO / 4 CO			
Rated control supply voltage U_s ¹⁾	V	24 DC	24 AC	115 AC	230 AC	24 DC	24 AC	115 AC	230 AC
Control side									
Operating range factor		0.9 ... 1.4	0.9 ... 1.1			0.9 ... 1.4	0.9 ... 1.1		
Power consumption at U_s									
• AC	VA	--	0.75			--	1		
• DC	W	0.4	--			0.75	--		
Release voltage	V	2.4	7.2	34.5	69	3.6	7.2	34.5	69
Protection circuit		Freewheel diode for complete unit	--			Freewheel diode in LED module	--		
Load side									
Switching voltage AC/DC	V	24 ... 250							
Rated currents²⁾									
• Conventional thermal current I_{th}									
- 1 CO contact	A	16				--			
- 2 CO contacts	A	6				12			
- 3 CO contacts	A	--				10			
- 4 CO contacts	A	--				6			
• Rated operational current I_e /AC-15 acc. to utilization categories (IEC 60947-5-1)	A	RT3 (1 CO contact): 6 RT4 (2 CO contacts): 2.5				PT2 (2 CO contacts): 5 PT3 (3 CO contacts): 5 PT5 (4 CO contacts): 4 (DC coils), 2 (AC coils)			
• Rated operational current I_e DC-13 with suppressor diode acc. to utilization categories (IEC 60947-5-1)	A	2 at 24 V, 0.27 at 230 V				PT2, PT3, PT5: 4 at 24 V, 0.5 at 230 V			
Short-circuit protection									
Short-circuit test with fuse links of operational class gG with short-circuit current $I_k = 1$ kA acc. to IEC 60947-5-1									
• DIAZED, type 5SB	A	10				6			
Min. contact load (reliability: 1 ppm)		Standard 17 V, 10 mA; hard gold-plated 17 V/0.1 mA				Standard 17 V, 10 mA; hard gold-plated 20 V/1 mA			
Mechanical endurance	Operating cycles	30 x 10 ⁶	10 x 10 ⁶						
Electrical endurance (resistive load at 250 V AC)	Operating cycles	1 x 10 ⁵							

¹⁾ AC voltages, 50 Hz; for 60 Hz operation, the lower response value must be increased by 10%; the power loss will decrease slightly.

²⁾ Capacitive loads can result in micro-welding on the contacts.

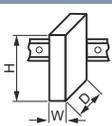
Relay type		LZS industrial relays: MT, 11-pin, octal base (35.5 mm) 3 CO contacts			
General data					
Dimensions (W x H x D)	mm	36 x 69 x 36			
					
Rated control supply voltage U_s¹⁾	V	24 DC	24 AC	115 AC	230 AC
Rated insulation voltage U_i (Pollution degree 3)	V	250			
Overvoltage category Acc. to IEC 60664-1	III				
Protective separation Between coil and contacts Acc. to IEC 60947-1, Appendix N	No				
Degree of protection of relays/bases					
• Relays	IP50				
• Bases	IP20				
Permissible ambient temperature					
• During operation	°C	-40 ... +60	-45 ... +50		
• During storage	°C	-45 ... +80			
Conductor cross-sections					
Connection type	⊕ Screw terminals				
• Solid	mm ²	2 x 2.5			
• Finely stranded with or without end sleeve	mm ²	2 x 1.5			
• Corresponding opening tool	Screwdriver, size 1 or Pozidriv 1				
Control side					
Operating range	V	18 ... 38	19.2 ... 38	92 ... 137	184 ... 264
Power consumption					
• AC	VA	--	2.3		
• DC	W	1.2	--		
Release voltage	V	2.4	9.6	46	92
Protection circuit	--				
Load side					
Switching voltage					
• AC/DC	V	24 ... 250			
Rated currents²⁾					
• Conventional thermal current I_{th}	A	10			
• Rated operational current I_e /DC-13 acc. to utilization categories (IEC 60947-5-1)	A	2 at 24 V, 0.27 at 230 V			
• Rated operational current I_e /AC-15 acc. to utilization categories (IEC 60947-5-1)	A	5 at 24 V and 230 V			
Short-circuit protection					
Short-circuit test with fuse links of operational class gG with short-circuit current $I_k = 1$ kA acc. to IEC 60947-5-1					
• DIAZED, type 5SB	A	10			
Min. contact load (reliability: 1 ppm)	12 V DC/10 mA				
Mechanical endurance	Operat- ing cycles	20 x 10 ⁶			
Electrical endurance (resistive load at 250 V AC)	Operat- ing cycles	4 x 10 ⁵			

¹⁾ AC voltages, 50 Hz; for 60 Hz operation, the lower response value must be increased by 10%; the power loss will decrease slightly.

²⁾ Capacitive loads can result in micro-welding on the contacts.