



contents

Introduction	13/4 – 13/6
SIRIUS 3SE5 mechanical position switches	
General data	13/7 – 13/13
3SE5, plastic enclosures	
– Enclosure width 31 mm according to EN 50047	13/14 – 13/19
– Enclosure width 40 mm according to EN 50041	13/20 – 13/23
– Enclosure width 50 mm 3SE5, metal enclosures	13/24 – 13/27
3SE5, metal enclosures	
– Enclosure width 31 mm according to EN 50047	13/28 – 13/31
– Enclosure width 40 mm according to EN 50041	13/32 – 13/35
– Enclosure width 56 mm	13/36 – 13/39
– Enclosure width 56 mm, XL	13/40 – 13/42
– Compact design	13/43 – 13/44
3SE5, open-type design	
– Enclosure width 30 mm	13/45
Accessories and spare parts	13/46 – 13/48
SIRIUS 3SE5, 3SE2 mechanical safety switches	
With separate actuator	
General data	13/49 – 13/50
3SE5, plastic enclosures	13/51 – 13/53
3SE5, metal enclosures	13/54 – 13/55
Accessories	13/56
3SE2, plastic enclosures	13/57
With tumbler	
General data	13/58 – 13/60
3SE5, plastic enclosures, locking force greater than 1 200 N	13/61 – 13/62
3SE5, metal enclosures, locking force greater than 2 000 N	13/63
Accessories	13/64 – 13/65
SIRIUS 3SE5, 3SE2 mechanical safety hinge switches	
General data	13/66
3SE5, plastic enclosures	13/67
3SE5, metal enclosures	13/68
3SE2, plastic enclosures	
– with integrated hinge	13/69 – 13/70
SIRIUS 3SE5 mechanical position switches for ambient temperatures down to -40 °C	
Shock and vibration test	
SIRIUS 3SE5 mechanical position switches	
– 3SE5, plastic enclosures	13/71
SIRIUS 3SE5 mechanical safety switches with tumbler	
– 3SE5, plastic enclosures	13/72
SIRIUS 3SE5 mechanical safety hinge switches	
– 3SE5, plastic enclosures	13/73
Shock and vibration test according to railway standard	
SIRIUS 3SE5 mechanical position switches	
– 3SE5, plastic enclosures	13/74 – 13/77
– 3SE5, metal enclosures	13/78 – 13/82
SIRIUS 3SE5 mechanical safety switches with separate actuator	
– 3SE5, plastic enclosures	13/83
SIRIUS 3SE5 mechanical safety switches with tumbler	
– 3SE5, plastic enclosures	13/84

Limit Switches and Safety

contents (cont.)

SIRIUS 3SF1 mechanical safety switches for AS-Interface

General data	13/85 – 13/86
3SF1, plastic enclosures	13/87 – 13/91
12/87 3SF1, metal enclosures	
With separate actuator	
General data	13/92 – 13/93
3SF1, plastic enclosures	13/94
3SF1, metal enclosures	13/95
Accessories	13/96
With tumbler	
General data	13/97
3SF1, plastic enclosures with locking force greater than 1 200 N	13/98
3SF1, metal enclosures with locking force greater than 2 000 N	13/99
Safety hinge switches	
3SF1, plastic enclosures	13/100
3SF1, metal enclosures	13/101

SIRIUS 3SE6 non-contact safety switches

Magnet	
3SE66, 3SE67 magnetically operated switches	13/102 – 13/107
RFID	
3SE63 RFID safety switches	13/108 – 13/111

3SE03 North American (NEMA) Limit Switches

Plug-in and NEMA 6P Submersible

Overview	13/114
Technical specifications, modular plug-in and NEMA Type 6P submersible	13/115
Ordering and selection data:	
Modular, plug-in metal housing	13/116
NEMA type 6P submersible, prewired cable	13/117
NEMA type 6P submersible, prewired receptacle	13/118
Modular, Plug-in and NEMA 6P submersible as components	13/119
Levers for plug-in and NEMA type 6P submersible	13/120 - 13/121
Wiring Diagrams	13/122
Dimension Diagrams	13/123 - 13/125

Metal Enclosure

Ordering and selection data	13/126 - 13/127
Specifications	13/126 - 13/127
Technical Data	13/127
Dimension drawings	13/126 - 13/127



3SE7 metal enclosures



3SK2 basic units



3RK3 modular safety system



contents (cont.)

3SE Mechanical Safety

3SE7 Cable-operated Switches

Overview, technical data and travel diagrams 13/128

Selection and ordering data 13/129 - 13/131

3SB3 Two-hand Control.

3SB3, selection and ordering data 13/132

Safety relays

SIRIUS 3SK safety relays

General data 13/133 - 13/139

Basic units

- SIRIUS 3SK1 Standard basic units 13/140

- SIRIUS 3SK1 Advanced basic units 13/141

- SIRIUS 3SK2 basic units 13/142

Expansion units

- Output expansions 13/143

- Input expansions 13/144

Accessories

13/145 - 13/147

SIRIUS 3TK28 safety relays

With special functions 13/148 - 13/149

Accessories

13/150

SIRIUS 3RK3 Modular Safety System

General data 13/151 - 13/158

3RK31 central units 13/159

3RK32, 3RK33 expansion modules 13/160

3RK35 interface modules 13/160

Accessories

13/161

SIRIUS 3RK and 3SK Safety Software

SIRIUS Safety ES 13/162 - 13/164

Overview



**3SE523.,
3SE521.,
3SF12.4**

**3SE524.,
3SF1244**

**3SE513.,
3SE511.,
3SF1114**

**3SE512.,
3SF1124**

3SE516.

**3SE5413,
3SE5423**

3SE5250

	Position switches, standard					Compact design	Open-type
Enclosure							
Plastic	✓	✓	✓	--	--	--	✓
Metal	✓	--	✓	✓	✓	✓	--
Dimensions (W x H x D) in mm	31 x 68 x 33	50 x 53 x 33	40 x 78 x 38	56 x 78 x 38	56 x 100 x 38	30 x 50 x 16 40 x 50 x 16	30 x 48.5 x 20
Degree of protection	IP65, IP66/IP67	IP66/IP67	IP66/IP67	IP66/IP67	IP66/IP67	IP66/IP67	IP10
Standards IEC 60947-5-1	Mounting and operating points acc. to EN 50047	Operating points acc. to EN 50047	Mounting and operating points acc. to EN 50041	Operating points acc. to EN 50041	Operating points acc. to EN 50041	--	Mounting and operating points acc. to EN 50047
Approvals	CE, TÜV, UL, CSA, CCC					CE, UL, CSA, CCC	CE, TÜV, UL, CSA, CCC
Contact blocks							
2 slow-action contacts	1 NO + 1 NC; 2 NC		1 NO + 1 NC; 2 NC		2 x (1 NO + 1 NC) --		1 NO + 1 NC
2 snap-action contacts	1 NO + 1 NC		1 NO + 1 NC		2 x (1 NO + 1 NC) 1 NO + 1 NC		1 NO + 1 NC
• Short stroke	1 NO + 1 NC		✓		--		✓
• With 2 x 2 mm contact gap	1 NO + 1 NC		✓		--		✓
3 slow-action contacts	1 NO + 2 NC; 2 NO + 1 NC		1 NO + 2 NC; 2 NO + 1 NC		--		1 NO + 2 NC; 2 NO + 1 NC
• With make-before-break	1 NO + 2 NC		1 NO + 2 NC		2 x (1 NO + 2 NC) --		1 NO + 2 NC
3 snap-action contacts	1 NO + 2 NC		1 NO + 2 NC		--		1 NO + 2 NC
Special features							
LED status display	✓		✓		--	--	--
Increased corrosion protection	✓		✓		✓	--	--
ASIsafe integrated	✓		✓		--	--	--
Electrical specifications							
Insulation voltage U_i	400 V		400 V			400 V	400 V
Conventional thermal current I_{th}	6 A/10 A (3-/2-pole)		6 A/10 A (3-/2-pole)			6 A	6 A
Connections							
Cable entry	1 x M20 x 1.5	2 x M20 x 1.5	1 x M20 x 1.5	3 x M20 x 1.5	3 x M20 x 1.5	--	--
M12 plug, 4-, 5- or 8-pole	✓	✓	✓	✓	✓	✓	--
Plug, 6-pole + PE	--	--	✓	✓	--	--	--
Molded cables	--	--	--	--	--	✓	--
Actuators							
Rounded plungers and roller plungers	✓		✓		✓	--	--
Roller levers and angular roller levers	✓		✓		✓	--	--
Spring rod	✓		✓		--	--	--
Twist levers and rod actuators	✓		✓		✓	--	--
Fork lever	--		✓		--	--	--
Hinge switches	--		--		--	--	--
Plungers, twist levers	--		--		✓	✓	✓
Page							
Complete units	13/14, 13/28	13/24	13/20, 13/32	13/36	13/40	13/43	13/45
Modular system	13/18, 13/30	13/26	13/22, 13/34	13/38	13/41	--	--
Ambient temperature -40 °C	13/71, 13/74	13/74	13/77	13/80	13/81	--	--
ASIsafe	13/87, 13/89	13/87	13/91	13/91	--	--	--

✓ Available -- Not available



3SE5232,
3SE5212,
3SF12.4

3SE5132,
3SE5112,
3SF11.4

3SE5232,
3SE5242,
3SF12.4

3SE5112,
3SE5122,
3SF11.4

3SE5322,
3SE5312,
3SF13.4

	Safety hinge switches		Safety switches with separate actuator		Safety switches with tumbler
Enclosure					
Plastic	✓	✓	✓	✓	✓
Metal	✓	✓	✓	✓	✓
Dimensions (W x H x D) in mm	31 x 68 x 33	40 x 78 x 38	31 x 68 x 33, 50 x 53 x 33	40 x 78 x 38, 56 x 78 x 38	54 x 185 x 44
Degree of protection	IP65, IP66/IP67	IP66/IP67	IP65, IP66/IP67	IP66/IP67	IP66/IP67, IP69K
Standards					
IEC 60947-5-1	Mounting and operating points acc. to EN 50047	Mounting and operating points acc. to EN 50041	Mounting acc. to EN 50047	Mounting acc. to EN 50041	EN ISO 14119
Approvals	CE, TÜV, UL, CSA, CCC		CE, TÜV, UL, CSA, CCC		CE, TÜV, UL, CSA, CCC
Contact blocks/outputs					
2 slow-action contacts	--	--	1 NO + 1 NC; 2 NC	--	--
2 snap-action contacts	1 NO + 1 NC	--	--	--	--
• Short stroke	--	--	--	--	--
• With 2 x 2 mm contact gap	--	--	--	--	--
3 slow-action contacts	--	--	1 NO + 2 NC	--	2 x (1 NO + 2 NC)
• With make-before-break	--	--	--	--	--
3 snap-action contacts	1 NO + 2 NC	--	--	--	--
Electronic safety outputs	--	--	--	--	--
Special features					
LED status display	✓	--	✓	--	✓
Increased corrosion protection	✓	--	✓	--	✓
ASIsafe integrated	✓	--	✓	--	✓
Electrical specifications					
Insulation voltage U_i	400 V	400 V	400 V	400 V	400 V
Conventional thermal current I_{th}	6 A/10 A (3-/2-pole)	6 A	6 A	6 A	6 A
Connections					
Cable entry	1 x M20 x 1.5	1 x M20 x 1.5	1 x M20 x 1.5, 2 x M20 x 1.5	1 x M20 x 1.5, 3 x M20 x 1.5	3 x M20 x 1.5
M12 plug, 4-, 5- or 8-pole	✓	--	✓	✓	✓
Molded cables	--	--	--	--	--
AS-Interface	--	--	✓	✓	✓
Actuators					
Plungers, twist levers	--	--	--	--	--
Separate actuators	--	--	✓	✓	✓
Hinge switches	✓	--	--	--	--
Page					
Complete units	13/67	13/67	13/51, 13/54	13/52, 13/55	13/61, 13/63
Modular system	—	—	—	—	—
ASIsafe	13/73	—	13/83	—	13/84
ATEX	13/100	13/101	13/94	13/95	13/98, 13/99

✓ Available
-- Not available

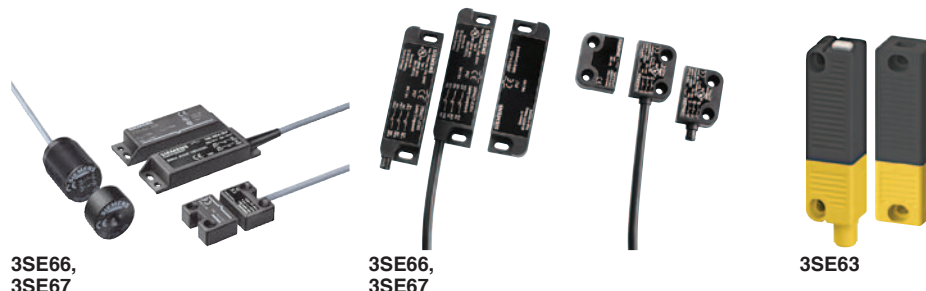

**3SE66,
3SE67**

**3SE66,
3SE67**

3SE63

	Safety switches, solenoid	Safety switches, solenoid supplementary range in new design ¹⁾	RFID safety switches ¹⁾
Enclosure			
Plastic	✓	✓	✓
Metal	--	--	--
Dimensions (W x H x D) in mm	M30; 25 x 88; 25 x 33	25 x 88; 26 x 36	25 x 91 x 22
Degree of protection	IP67	IP67	IP69K
Standards	IEC 60947-5-3 Category 4 acc. to ISO 13849-1, PL e acc. to ISO 13849-1, SIL 3 acc. to IEC 61508	IEC 60947-5-3	Category 4 acc. to ISO 13849-1, PL e acc. to ISO 13849-1, SIL 3 acc. to IEC 61508
Approvals	CE, TÜV, UL, CSA, CCC	CE, TÜV, UL, CSA	CE, TÜV, UL, CSA
Contact blocks/outputs			
Reed contacts	1 NO + 1 NC 2 NC 1 NO + 1 NC (+ 1 NC signaling contact)	1 NO + 1 NC (+ 1 NC signaling contact) 2 NC 2 NC (+ 1 NC signaling contact)	--
Special features			
LED status display	--	✓	✓
Increased corrosion protection	--	--	✓
ASIsafe integrated	--	--	--
Electrical specifications			
Insulation voltage U_i	100 V AC/DC 24 V DC	75 V DC 50 V AC	--
Conventional thermal current I_{th}	250 mA 400 mA	250 mA	--
Connections			
M8 plug, 4-pole	✓	✓	--
8 mm Ø, latching connection, plug, 6-pole	--	✓	--
M12 plug, 4-pole	✓	--	✓
Molded cables	✓	✓	--
AS-Interface	--	--	--
Actuators			
RFID	--	--	✓
Switching magnet	✓	✓	--
Page	13/102	13/102	13/108

✓ Available

-- Not available

¹⁾ CCC not required for voltages < 36 V.

Overview

More information

Homepage, see www.usa.siemens.com/limit-switches
 Industry Mall, see www.siemens.com/product?3SE
 Configurator, see www.siemens.com/sirius/configurators
 System Manual, see <https://support.industry.siemens.com/cs/ww/en/view/43920150>
 Conversion tool, see www.siemens.com/sirius/conversion-tool

The innovative SIRIUS 3SE5 position switches are modern in design, compact, modular and simple to connect. They save time and increase flexibility during installation of a whole range of switch variants. In principle it is possible to combine any enclosure with any operating mechanism, paying due consideration to the EN 50041 and EN 50047 standards where necessary.

Complete units

Popular versions of the position switches in standard enclosures are available as complete units.



3SE5 position switches with plastic and metal enclosures

Modular system

The 3SE5 series is the modular system comprising different sizes of the basic switch and an actuator which must be ordered separately. Thanks to the modular design of the switch the user can select the right solution for his application from numerous versions and install it himself in a very short time.

Simple plug-in mounting enables fast replacement of the actuator heads.



Examples of selection options in the modular system

Design

All enclosure variants have an integrated chlorinated rubber diaphragm for high functional safety in cold and aggressive environments.

Enclosure sizes

The 3SE5 switches are available in five different enclosure sizes with 2 or 3 contacts and with the XL enclosure:

- Plastic enclosures according to EN 50047, 31 mm wide, IP65, 1 cable entry
- Metal enclosures according to EN 50047, 31 mm wide, IP66/IP67, 1 cable entry
- Plastic and metal enclosures according to EN 50041, 40 mm wide, IP66/IP67, 1 cable entry
- Plastic enclosures, 50 mm wide, IP66/IP67, 2 cable entries
- Metal enclosures, 56 mm wide, IP66/IP67, 3 cable entries
- XL metal enclosures with 4 to 6 contacts, 56 mm wide, IP66/IP67, 3 cable entries

Enclosure versions

Various basic switches can be selected for the enclosures of the 3SE5 series:

- With contact blocks with two or three contacts (screw terminals) designed as slow-action or snap-action contacts; the slow-action contacts also with make-before-break
- Optional LED status display
- With mounted 4- or 5-pole M12 device plug (available for the wide enclosures as an accessory for self-assembly)
- With 6-pole device plug + PE on the metal enclosures
- Versions with increased corrosion protection
- Versions for operating temperatures down to -40 °C
- AS-Interface version with integrated ASIsafe electronics for all enclosure designs (see page 13/85).

Actuator variants

All operating mechanisms can be rotated around the axis in increments of 22.5°. The following actuator variants are available:

- Plain, rounded and roller plungers
- Roller levers and angular roller levers
- Spring rod
- Twist levers and rod actuators with twist actuator
- Fork levers with twist actuator

The actuator rollers are available with various materials and diameters.

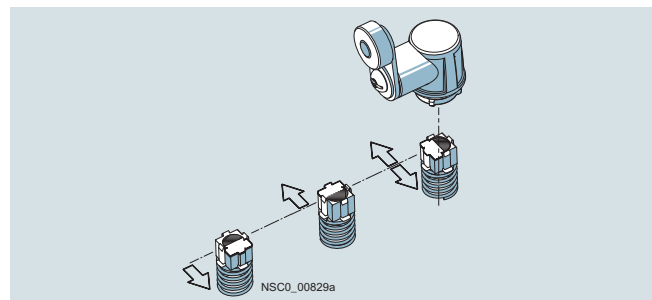

Twist actuator for twist levers and rod levers, with setting of switching direction to right, left or right/left (standard for all twist actuators except fork levers)

General data

Cover design

The mechanical position switches have a turquoise cover and the mechanical safety switches have a yellow cover.



On request the switches can be delivered ex works with a yellow cover. The cover has no effect on the mode of operation. Both versions can be used in safety applications, (see also page 13/16).

Diverse contact types

Exchangeable two- and three-pole contact blocks for all enclosure sizes



The three-pole contact block with snap-action or slow-action contacts is regularly available for all enclosure forms. The same installation space is required as for a two-pole block. The version with 1 NO + 2 NC offers, for example, more safety through redundant shutdowns (2 NC contacts) with simultaneous signaling (NO contact). The three-pole blocks are also available with make-before-break and with 2 NO + 1 NC.

Contact reliability

The contact blocks ensure an extremely high contact stability. This applies even when the devices are switching low voltages and currents, e.g. 1 mA at 5 V DC.

Positive opening ➔

The NC contacts of the switch are forced open mechanically, positively-driven and reliably by the plunger. This is referred to as "positive opening".

Mounting

Easy plug-in method for fast replacement of the actuator heads

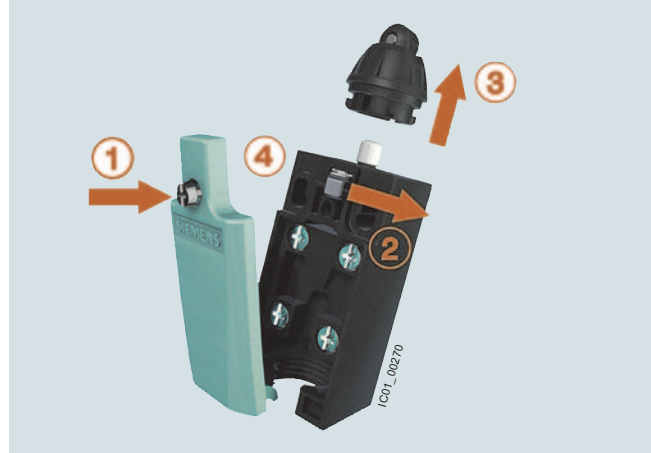

Open the cover (1)
Actuate the locking lever (2)
Replace the head (turnable by 16 x 22.5°) (3)
Lock and close the cover (4)

Quick-connect technology

For plastic enclosure with a width of 31 mm



These position switches can be wired quickly and easily as an added customer benefit. The connecting cable is first connected to the terminals of the contact block and then guided through a slit into the cable gland opening. The time saved through this new connection method is approx. 20 to 25%.

A cable gland with seal must be used with the quick-connect method.

Optional LED indicators

LED indicators are available for all enclosure sizes except for XL. The enclosures are supplied with an LED signaling indicator (1 x green + 1 x yellow). This is the first time that optical signaling equipment is also available for small standard enclosures according to EN 50047. The LEDs are implemented in 24 V DC and 230 V AC.

General data

Article No. scheme

Product versions		Article number													
SIRIUS position and safety switches		3	S	E	□	□	□	□	-	□	□	□	□	□	
Series		5													
Standard		EN 50041		1		2		3							
		EN 50047 with tumbler													
Enclosure material and width		e.g. 1 = metal, narrow										□			
Connection		Cable entry, device plug										2 4/5			
LEDs		None						0		1		2		3	
		24 V DC													
		115 V AC													
		230 V AC													
Version of contacts		e.g. C = snap-action 1 NO + 1 NC										□			
Version of operating mechanism		e.g. C02 = rounded plunger										□	□	□	
Example		3	S	E	5	1	1	2	-	0	C	C	0	2	

Note:

The Article No. scheme shows an overview of product versions for better understanding of the logic behind the article numbers.

For your orders, please use the article numbers quoted in the selection and ordering data.

Benefits

The 3SE5 position switches differ from the previous series through the following new characteristics:

- The modular design of the product range allows a number of versions with a smaller number of bearing types for enclosures and operating mechanisms.
- All actuators can be turned around the axis in increments of 22.5° (see picture, page 13/8).
- Rounded and roller plungers according to EN 50041 with 3 mm overtravel (total travel 9 mm) for greater tolerance when switching.
- All enclosure sizes – now also including the small enclosure 31 mm wide – are optionally available with an LED signaling indicator (see picture, page 13/8).
- All enclosure variants have an integrated chlorinated rubber diaphragm for high functional safety in cold and aggressive environments.
- All contact blocks are replaceable (see page 13/47).

- The three-pole contact blocks are available for all enclosure sizes (see picture, page 13/8).
- Elements with 1 NO + 2 NC slow-action contacts with make-before-break and 2 NO + 1 NC.
- The short-stroke contact block 1 NO + 1 NC improves the precision of the switching operation through a reduced actuation path.
- The contact block with 1 NO + 1 NC snap-action contacts with 2 x 2 mm contact opening is suitable for simultaneous shutdown and signaling, particularly in the elevator industry.
- XL metal enclosures for accommodating two 2- or 3-pole contact blocks.
- The plastic enclosure with a width of 31 mm has simple and fast wiring equipment which makes it possible to save approx. 20 to 25% of the time when connecting (see picture, page 13/8).

Application

With the standard position switches, mechanical positions of moving machine parts are converted into electrical signals. Through their modular and uniform design and large number of variants, the devices can comply with practically all requirements in industry.

Devices are available with enclosure versions to suit the particular ambient conditions. Different control tasks can be performed with the contact blocks best suited for the particular purpose. And many different actuator variants are available to match the mechanical configuration of the moving machine parts. Dimensions, fixing points and characteristics are largely in accordance with the EN 50041 or EN 50047 standards.

The devices are suitable for use in any climate.

Standards

IEC/EN 60947-5-1

The protective measure of "total insulation" by the molded-plastic enclosure is ensured by the use of molded-plastic screw glands.

Safety position switches

For controls according to IEC/EN 60204-1, the devices can be used as a safety position switch. They comply with the standard EN ISO 14119. A TÜV certificate is available. To secure position switches against changes in their position, keyed techniques must be employed on installation.

Safety circuits

The IEC/EN 60947-5-1 standard requires positive opening of the NC contacts. In other words, for the purposes of personal safety, the assured opening of NC contacts is expressly stipulated for the electrical equipment of machines in all safety circuits and marked in accordance with the standard IEC 60947-5-1 with the symbol ☹.

Category 2 according to EN ISO 13849-1 can be attained with 3SE5 position switches with ☹, and category 3 or 4 when using an additional position switch, if the corresponding fail-safe evaluation units are selected and correctly connected. Example: 3SK or 3TK28 safety relays or the corresponding devices from the ASIsafe, SIMATIC or SINUMERIK programs. The operating mechanisms (actuators) must also be connected to the enclosure by keyed techniques. The corresponding operating mechanisms are marked in the catalog with ☹.

General data

Contacts for every application

- Snap-action contacts: NC and NO contacts switch simultaneously – regardless of the actuating speed ($v_{min} = 0.01$ m/s) and contact erosion.
- Slow-action contacts: Difference in travel between "NC contact opens" and "NO contact closes"; the switching speed is the same as or proportional to the actuating speed ($v_{min} = 0.4$ m/s).
- Slow-action contacts with make-before-break: e.g. suitable for adding a second function to a sequence control.

Operating mechanisms for every application

Standard, rounded and roller plungers

- Operation in direction of the plunger axis or in case of roller plunger with bar at right angles to the plunger axis.
- The roller plunger is recommended for lateral actuation and relatively long overtravel.

Roller levers and angular roller levers

- For actuators made of finely ground steel in the form of cams, straight-edges (approach angle 30°) or cam disks.

Spring rod

- Can be used for undefined actuations and changing starting conditions
- Starting from any direction is possible







Twist levers and rod actuators

- For high starting speeds ($v = 1.5$ m/s)
- Variety of starting options
- Insensitive to oil, grinding dust and coarse-grained material
- Adjustment of the lever in increments of 10°
- Can be adjusted with left or right switching

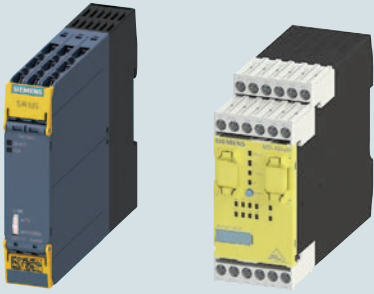
Fork lever

- Switchable in two directions
- Latching actuator
- For reciprocating movements

Monitoring with fail-safe evaluation units from the 3SK and 3RK3 series

Safe evaluation units	Maximum achievable safety level according to type of switch				
	Compact	Standard	Hinge	Separate actuator	Tumbler
 <p>3SK 3RK3</p>	 <p>3SE54</p>	 <p>3SE51/3SE52</p>	 <p>3SE51/3SE52</p>	 <p>3SE51/3SE52</p>	 <p>3SE53</p>
Use of only one position/safety switch					
Monitoring with 1 contact: 1 x NC contact	SIL 1 / PL c				
Monitoring with 2 contacts: 2 x NC contact or 1 x NC contact + 1 x NO contact	SIL 1 / PL c	SIL 2 / PL d			
Use of a second position/safety switch					
Standard switch 3SE51/3SE52	SIL 3 / PL e				
Safety switch/hinge switch 3SE51/3SE52					
Safety switch with separate actuator 3SE51/3SE52					
Safety switch with tumbler 3SE53					

Note:

Taking account of certain fault exclusions (e.g. actuator breakage), use of just one hinge switch or a switch with separate actuator with or without tumbler up to SIL 2 or PL d is possible as described in the table.

Since the machine manufacturer must provide proof of fault exclusion, the component manufacturer is unable to carry out a definitive assessment of the measures taken.

For more information, see <https://support.industry.siemens.com/cs/ww/en/view/35443942>.

The maximum achievable SIL or PL always depends on other assumptions as well. Factors to be taken into account include the DC (declaration), the CCF, and the number of actuations.

For information on the safe evaluation units and an introduction to safety systems, see page 13/133 onwards.

Technical specifications

Type		3SE51.. ¹⁾ , 3SE52.. ¹⁾	3SE541.	3SE542.
General data				
Standards		IEC/EN 60947-5-1, EN ISO 14119		
Rated insulation voltage U_i	V	400 ²⁾	400	
Degree of pollution according to IEC 60664-1		Class 3	Class 3	
Rated impulse withstand voltage U_{imp}	kV	6	4	
Rated operational voltage U_e	V	400 AC; over 300 V AC same potential only ³⁾	300 AC	
Conventional thermal current I_{th}	A	10	10	
Rated operational current I_e				
• For alternating current 50/60 Hz		I_e / AC-15	I_e / AC-15	
- At 24 V	A	6	6	
- At 120 V	A	6	6	
- At 240 V	A	6	3	
- At 400 V	A	4	--	
• For direct current		I_e / DC-13	I_e / DC-13	
- At 24 V	A	3	3	
- At 125 V	A	0.55	0.55	
- At 250 V	A	0.27	0.27	
- At 400 V	A	0.12	--	
Short-circuit protection⁴⁾				
• With DIAZED fuse links, utilization category gG	A	6	10	
• With miniature circuit breaker, C char. ($I_{K < 400A}$)	A	1	3	
Mechanical endurance				
• Basic switch		15 × 10 ⁶ operating cycles	10 × 10 ⁶ operating cycles	10 × 10 ⁶ operating cycles
• With spring rod, 3SE5...-..R..		10 × 10 ⁶ operating cycles	--	--
• With fork lever, 3SE51...-..T..		1 × 10 ⁶ operating cycles	--	--
Electrical endurance				
• With 3RH.1, 3RT contactors in size S00, S0		10 × 10 ⁶ operating cycles	500 000 operating cycles	500 000 operating cycles
• For utilization category AC-15 when switching off I_e / AC-15 at 240 V		100 000 operating cycles	100 000 operating cycles	100 000 operating cycles
• With utilization category DC-12/DC-13		For direct current depending on the loading of the switch		
Switching frequency				
With 3RH.1, 3RT contactors in size S00, S0		6 000 operating cycles/h	1 800 operating cycles/h	
Switching accuracy				
• For repeated switching, measured at the plunger of the contact block	mm	0.05	0.05	
• With twist actuators		1°	1°	
Rated data according to \mathcal{E}, \mathcal{Q} and \mathcal{N}				
• Rated voltage	V	300	300	
• Uninterrupted current	A	6	10	
• Switching capacity		Heavy duty, A 300/B 300/Q 300	A 300/Q 300	

1) Special versions, see data sheet.

2) For slow-action contacts 1 NO + 2 NC with make-before-break ("M") and 2 NO + 1 NC ("P") the following applies: 250 V.

3) For slow-action contacts 1 NO + 2 NC with make-before-break ("M") and 2 NO + 1 NC ("P") the following applies: Over 250 V AC same potential only.

4) Without any welds according to IEC 60947-5-1.

Type		3SE523.	3SE513.	3SE524.	3SE521.	3SE511.	3SE512., 3SE516.	3SE54..	3SE525.
Enclosure									
• Material		Plastic P66			Zinc die-casting			Zn/Al	--
• Width	mm	31	40	50	31	40	56	30/40	30
Degree of protection acc. to IEC 60529		IP65	IP66/IP67 ¹⁾					IP67	IP10
Ambient temperature									
• During operation	°C	-25 ... +85; -40...+85 for 3SE5*-1AJ0 and 3SE5*-1AY0 versions						-25 ... +85	-25 ... +85
• In operation, switch with LEDs	°C	-25 ... +60						--	--
• Storage, transport	°C	-40 ... +90						-40 ... +90	-40 ... +90
Mounting position		Any							
Connection									
Cable entry		1 x (M20 x 1.5)	2 x (M20 x 1.5)	1 x (M20 x 1.5)	3 x (M20 x 1.5)	--	--	--	--
Conductor cross-sections									
• Solid	mm ²	1 x (0.5 ... 1.5), 2 x (0.5 ... 0.75)							
• Finely stranded with end sleeve	mm ²	1 x (0.5 ... 1.5), 2 x (0.5 ... 0.75)							
• AWG cables, solid or stranded	AWG	1 x (AWG 20 ... 16), 2 x (AWG 20 ... 18)							
Tightening torque , contact block	Nm	0.8 ... 1.0							
Protective conductor connection inside enclosure		--			M3.5			--	--

1) For actuator heads with spring rod and rod actuators: IP65/IP67.

General data

Circuit diagrams

Enclosure widths 31, 40, 50 and 56 mm

Slow-action contacts
1 NO + 1 NC
3SE5...-B..., -R...

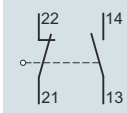

Slow-action contacts
2 NO + 1 NC
3SE5...-P...

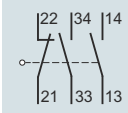

Snap-action contacts
1 NO + 1 NC
3SE5...-C..., -F..., -G..., -H..., -N...

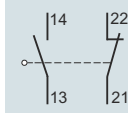

Slow-action contacts
1 NO + 2 NC
3SE5...-K..., -Q...

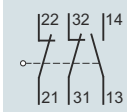

Slow-action contacts
1 NO + 2 NC with
make-before-break, 3SE5...-M...

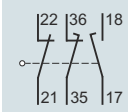

Snap-action contacts
1 NO + 2 NC
3SE5...-L...

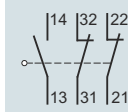

XL enclosures, width 56 mm

Slow-action contacts
2 x (1 NO + 1 NC)
3SE5162-0B...

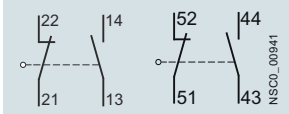

Slow-action contacts
2 x (1 NO + 2 NC) with
make-before-break, 3SE5162-0D...

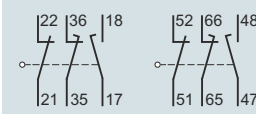

Slow-action contacts
1 NO + 2 NC with make-before-break,
1 NO + 1 NC
3SE5162-0E...

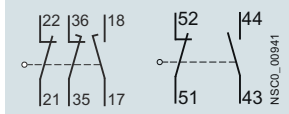

Snap-action contacts
2 x (1 NO + 1 NC)
3SE5162-0C...

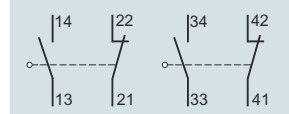

3SE5 pin assignment

M12 device plug, 4-pole
3SY3127



M12 device plugs, 5-pole
3SY3128

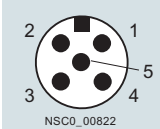

M12 device plugs, 8-pole
3SX5100-1SS08

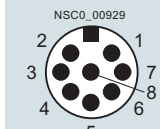

Device plugs, 6-pole + PE
3SY3131

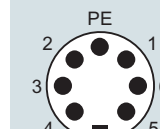

Type	Device plugs Type	Contacts Version	LEDs Version	Connections									
				Pin 1	Pin 2	Pin 3	Pin 4	Pin 5	Pin 6	Pin 7	Pin 8	PE	
M12 device plugs, 4-, 5- or 8-pole													
3SE5..4-0....-1AC4	3SY3127	1 NO + 1 NC	--	21	22	13	14	--	--	--	--	--	--
3SE5..4-0....-1AL0	3SY3128	1 NO + 1 NC	--	21	22	13	14	PE	--	--	--	--	--
3SE5..4-0....-1AE0	3SY3127	2 NC	--	21	22	31	32	--	--	--	--	--	--
3SE5..4-0....-1AE1	3SY3128	2 NC	--	21	22	31	32	PE	--	--	--	--	--
3SE5..4-1C....-1AF5	3SY3128	1 NO + 1 NC snap-action	2 LEDs	21	22	13/ LED gn	14/ LED ye	Ground LED	--	--	--	--	--
3SE5..4-1B....-1AF3	3SY3128	1 NO + 1 NC slow-action	2 LEDs	21	22	14/ LED gn	13/ LED ye	Ground LED	--	--	--	--	--
3SE5..4-1L....-1AD4	3SY3134	1 NO + 2 NC snap-action	2 LEDs	21	22	13/ LED gn	14/ LED ye	31	32	Ground LED	PE	--	--
3SE5..4-1K....-1AD4	3SY3134	1 NO + 2 NC slow-action	2 LEDs	21	22	14/ LED gn	13/ LED ye	31	32	Ground LED	PE	--	--
Device plugs, 6-pole + PE													
3SE5..5-0....-1AD0	3SY3131	1 NO + 1 NC	--	21	22	13	14	--	--	--	--	--	✓
3SE5..5-0....-1AD1	3SY3131	1 NO + 2 NC	--	21	22	13	14	31	32	--	--	--	✓
3SE5..5-C....-1AF2	3SY3131	1 NO + 1 NC snap-action	2 LEDs	21	22	13/ LED gn	14/ LED ye	--	Ground LED	--	--	--	✓
3SE5..5-B....-1AF2	3SY3131	1 NO + 1 NC slow-action	2 LEDs	21	22	14/ LED gn	13/ LED ye	--	Ground LED	--	--	--	✓
3SE5..5-L....-1AD2	3SY3131	2 NC snap-action	2 LEDs	21	22	31	32	13/ LED gn	Ground LED	--	--	--	✓
3SE5..5-K....-1AD2	3SY3131	2 NC slow-action	2 LEDs	21	22	31	32	14/ LED gn	Ground LED	--	--	--	✓

Legend: gn = green, ye = yellow

✓ Connected -- Not available

General data

Options

On the following pages you will find selection tables for complete units as well as components of the modular system.

- Complete units
- Modular system

The differences between the units are indicated in the selection and ordering data by the symbols shown on orange backgrounds.

Using the modular system you can assemble switch variants which are not available as complete units. Each complete unit can also be supplied as a module.

A basic switch for the modular system comprises an enclosure with a contact block and a cover. Among the basic switches the following versions, for example, can be selected:

- Basic enclosure with teflon plunger
- Version with increased corrosion protection
- Version with M12 device plug and/or with 2 LEDs
- Version with M12 device plug or 6-pole + PE

Complete units

Ordering example

Required:

- Position switch according to EN 50047 in a plastic enclosure
- Contact block with slow-action contacts 1 NO + 1 NC
- Angular roller lever, metal lever and plastic roller

Support functions

The 3SE5/3SF1 position and safety switches can also be ordered using an online configurator.

This also enables a complete documentation to be prepared:

- Product data sheets
- Dimension drawings
- Operating travel diagrams
- CAD data in 2D and 3D model images
- Ordering data
- Product photos

For online configurator, see www.siemens.com/sirius/configurators.

To be ordered:

Version	Complete units <input type="checkbox"/>
Article No.	

Complete units · Enclosure width 31 mm



Angular roller lever

With metal lever and plastic roller 13 mm

Slow-action contacts
1 NO + 1 NC

3SE5232-0BF10

Modular system

Ordering example 1

Required:

- Position switch according to EN 50047 in a plastic enclosure
- Contact block with slow-action contacts 1 NO + 1 NC
- Angular roller lever, metal lever and plastic roller

Ordering example 2

Required:

- Position switch according to EN 50047 in a plastic enclosure
- Contact block with slow-action contacts 1 NO + 1 NC
- Twist levers, high-grade steel lever and plastic roller

To be ordered separately:

Version	Modular system <input checked="" type="checkbox"/>
Article No.	

To be ordered separately:

Version	Modular system <input checked="" type="checkbox"/>
Article No.	

Basic switches · Enclosure width 31 mm



With teflon plunger

Slow-action contacts
1 NO + 1 NC

3SE5232-0BC05

Basic switches · Enclosure width 31 mm



With teflon plunger

Slow-action contacts
1 NO + 1 NC

3SE5232-0BC05

+

+

Operating mechanisms



Angular roller levers

Metal lever,
plastic roller

3SE5000-0AF10

Twist actuators



Twist actuators

3SE5000-0AK00



Twist levers

High-grade steel lever,
plastic roller

3SE5000-0AA31

SIRIUS 3SE5 Mechanical Position Switches

3SE5, Plastic Enclosures

Enclosure width 31 mm according to EN 50047

Selection and ordering data

Complete units for installation in control cabinets

2 contacts · Degree of protection IP40 · Cable entry by means of a locking plug with Ø 6 mm

Version	Contacts	LEDs	SD	Complete units	PU (UNIT, SET, M)	PS*
			d	Article No.	Price per PU	

Complete units¹⁾ · Enclosure width 31 mm

Control cabinet type, IP40, rounded plungers, type B, acc. to EN 50047

Flat cover

Snap-action contacts, integrated²⁾ 1 NO + 1 NC -- ⊕ 5 **3SE5232-0HC05-1AB1** 1 1 unit



3SE5232-0HC05-1AB1

With mounting plate and screws for attachment profile

Snap-action contacts, integrated²⁾ 1 NO + 1 NC -- ⊕ 5 **3SE5232-0HC05-1AB2** 1 1 unit



3SE5232-0HC05-1AB2

Standard cover

Snap-action contacts, integrated²⁾ 1 NO + 1 NC -- ⊕ 5 **3SE5232-0HC05-1AB3** 1 1 unit



3SE5232-0HC05-1AB3

With mounting plate and screws for attachment profile

Snap-action contacts, integrated²⁾ 1 NO + 1 NC -- ⊕ 5 **3SE5232-0HC05-1AB4** 1 1 unit



3SE5232-0HC05-1AB4

Accessories

Mounting plate

Suitable for 3SE523 and 3SE521 position switches with a width of 31 mm

-- -- 5 **3SX5100-1A** 1 1 unit



3SX5100-1A

⊕ Positive opening according to IEC 60947-5-1, Appendix K.

¹⁾ The control cabinet types are not basic switches for the modular system.

²⁾ Subsequent replacement of contact blocks is not possible.

SIRIUS 3SE5 Mechanical Position Switches

3SE5, Plastic Enclosures

Enclosure width 31 mm according to EN 50047

Complete units

2 or 3 contacts · Degree of protection IP65 · Cable entry M20 × 1.5¹⁾

Version	Contacts	LEDs	SD	Complete units	Price per PU	PU (UNIT, SET, M)	PS*
			d	Article No.			

Complete units²⁾ · Enclosure width 31 mm



Rounded plungers, type B, acc. to EN 50047

With teflon plunger

Slow-action contacts	1 NO + 1 NC	--	⊕ ▶	3SE5232-0BC05		1	1 unit
Snap-action contacts	1 NO + 1 NC	--	⊕ 5	3SE5232-0CC05		1	1 unit
Snap-action contacts, integrated ³⁾	1 NO + 1 NC	--	⊕ ▶	3SE5232-0HC05		1	1 unit
Snap-action contacts • Short stroke, integrated ³⁾	1 NO + 1 NC	--	⊕ 5	3SE5232-0FC05		1	1 unit
Snap-action contacts • 2 × 2 mm contact gap	1 NO + 1 NC	--	⊕ 15	3SE5232-0GC05		1	1 unit
Slow-action contacts	1 NO + 2 NC	--	⊕ ▶	3SE5232-0KC05		1	1 unit
Snap-action contacts	1 NO + 2 NC	--	⊕ ▶	3SE5232-0LC05		1	1 unit
Slow-action contacts with make-before-break	1 NO + 2 NC	--	⊕ 2	3SE5232-0MC05		1	1 unit
Slow-action contacts	2 NO + 1 NC	--	⊕ 2	3SE5232-0PC05		1	1 unit

3SE5232-0HC05-1AB1



With increased corrosion protection

Slow-action contacts	1 NO + 1 NC	--	⊕ 5	3SE5232-0BC05-1CA0		1	1 unit
Snap-action contacts	1 NO + 1 NC	--	⊕ 5	3SE5232-0CC05-1CA0		1	1 unit
Slow-action contacts	1 NO + 2 NC	--	⊕ 5	3SE5232-0KC05-1CA0		1	1 unit
Snap-action contacts	1 NO + 2 NC	--	⊕ 5	3SE5232-0LC05-1CA0		1	1 unit
Slow-action contacts with make-before-break	1 NO + 2 NC	--	⊕ 5	3SE5232-0MC05-1CA0		1	1 unit
Slow-action contacts	2 NO + 1 NC	--	⊕ 5	3SE5232-0PC05-1CA0		1	1 unit

3SE5232-0BC05-1CA0

With M12 device plug, 4-pole (250 V, 4 A)

Slow-action contacts	1 NO + 1 NC	--	⊕ 5	3SE5234-0BC05-1AC4		1	1 unit
Snap-action contacts, integrated ³⁾	1 NO + 1 NC	--	⊕ 2	3SE5234-0HC05-1AC4		1	1 unit
Slow-action contacts	2 NC	--	⊕ 5	3SE5234-0KC05-1AE0		1	1 unit
Snap-action contacts	2 NC	--	⊕ 2	3SE5234-0LC05-1AE0		1	1 unit



With 2 LEDs, yellow/green

Slow-action contacts	1 NO + 2 NC	24 V DC	⊕ 5	3SE5232-1KC05		1	1 unit
Snap-action contacts	1 NO + 2 NC	24 V DC	⊕ 5	3SE5232-1LC05		1	1 unit
Slow-action contacts	1 NO + 2 NC	230 V AC	⊕ 5	3SE5232-3KC05		1	1 unit
Snap-action contacts	1 NO + 2 NC	230 V AC	⊕ 5	3SE5232-3LC05		1	1 unit

3SE5232-1KC05

With M12 device plug, 5-pole (125 V, 4 A), and 2 LEDs

Slow-action contacts	1 NO + 1 NC	24 V DC	⊕ 5	3SE5234-1BC05-1AF3		1	1 unit
Snap-action contacts	1 NO + 1 NC	24 V DC	⊕ 5	3SE5234-1CC05-1AF3		1	1 unit



With M12 device plug, 5-pole (125 V, 4 A), with pin assignment as for SIMATIC ET 200⁴⁾ **NEW**

Snap-action contacts	1 NO + 1 NC	24 V DC	⊕ X	3SE5234-0LC05-1AE2		1	1 unit
----------------------	-------------	---------	-----	---------------------------	--	---	--------

3SE5234-0LC05-1AE2

⊕ Positive opening according to IEC 60947-5-1, Appendix K.

¹⁾ A cable gland with seal must be used with the quick-connect method.

²⁾ Popular versions.

³⁾ Subsequent replacement of contact blocks is not possible.

⁴⁾ The 3SE5234-.....-1AE2 position switches, prewired with an M12 plug, 5-pole, have the same pin assignment as all compact block I/O modules with a PROFINET connection in the SIMATIC ET 200eco PN, ET 200eco PN-F and ET 200AL series with IP65/IP67 degree of protection for cabinet-free installation directly at the machine.

SIRIUS 3SE5 Mechanical Position Switches

3SE5, Plastic Enclosures

Enclosure width 31 mm according to EN 50047

2 or 3 contacts · Degree of protection IP65 · Cable entry M20 × 1.5¹⁾

Version	Contacts	LEDs	SD	Complete units	Price per PU	PU (UNIT, SET, M)	PS*
			d	Article No.			

Complete units²⁾ · Enclosure width 31 mm



3SE5232-0BD03

Roller plungers, type C, acc. to EN 50047

With plastic roller 10 mm

Slow-action contacts	1 NO + 1 NC	--	⊕	5	3SE5232-0BD03		1	1 unit
Snap-action contacts • Integrated ³⁾	1 NO + 1 NC	--	⊕ ▶		3SE5232-0HD03		1	1 unit
Snap-action contacts • Short stroke, integrated ³⁾	1 NO + 1 NC	--	⊕	5	3SE5232-0FD03		1	1 unit
Slow-action contacts	1 NO + 2 NC	--	⊕	5	3SE5232-0KD03		1	1 unit
Snap-action contacts	1 NO + 2 NC	--	⊕	5	3SE5232-0LD03		1	1 unit

Actuator head rotated by 90°

Snap-action contacts	1 NO + 2 NC	--	⊕	5	3SE5232-0LD03-1AH0		1	1 unit
----------------------	-------------	----	---	---	--------------------	--	---	--------

With M12 device plug, 4-pole (250 V, 4 A)

Snap-action contacts, integrated ³⁾	1 NO + 1 NC	--	⊕	5	3SE5234-0HD03-1AC4		1	1 unit
--	-------------	----	---	---	--------------------	--	---	--------

With M12 device plug, 5-pole (125 V, 4 A), with pin assignment as for SIMATIC ET 200⁴⁾ **NEW**

Snap-action contacts	1 NO + 2 NC	--	⊕	X	3SE5234-0LD03-1AE2		1	1 unit
----------------------	-------------	----	---	---	--------------------	--	---	--------

With yellow cover

Snap-action contacts	1 NO + 2 NC	--	⊕	5	3SE5232-0LD03-1AG0		1	1 unit
----------------------	-------------	----	---	---	--------------------	--	---	--------



3SE5232-0LD03-1AG0

Roller plungers with central fixing

With plastic roller 10 mm

Snap-action contacts, integrated ³⁾	1 NO + 1 NC	--	⊕	5	3SE5232-0HD10		1	1 unit
Slow-action contacts	1 NO + 2 NC	--	⊕	5	3SE5232-0KD10		1	1 unit



3SE5232-0HD10

Roller levers, type E acc. to EN 50047

With metal lever and plastic roller 13 mm

Slow-action contacts	1 NO + 1 NC	--	⊕	2	3SE5232-0BE10		1	1 unit
Snap-action contacts, integrated ³⁾	1 NO + 1 NC	--	⊕ ▶		3SE5232-0HE10		1	1 unit
Slow-action contacts	1 NO + 2 NC	--	⊕	5	3SE5232-0KE10		1	1 unit
Snap-action contacts	1 NO + 2 NC	--	⊕	5	3SE5232-0LE10		1	1 unit



3SE5232-0HE10

With increased corrosion protection, with high-grade steel lever and plastic roller 13 mm

Snap-action contacts	1 NO + 1 NC	--	⊕	5	3SE5232-0CE12-1CA0		1	1 unit
----------------------	-------------	----	---	---	--------------------	--	---	--------

With M12 device plug, 4-pole (250 V, 4 A)

Snap-action contacts, integrated ³⁾	1 NO + 1 NC	--	⊕	5	3SE5234-0HE10-1AC4		1	1 unit
--	-------------	----	---	---	--------------------	--	---	--------

With M12 device plug, 5-pole (125 V, 4 A), with pin assignment as for SIMATIC ET 200⁴⁾ **NEW**

Snap-action contacts	1 NO + 2 NC	--	⊕	X	3SE5234-0LE11-1AE2		1	1 unit
----------------------	-------------	----	---	---	--------------------	--	---	--------

With high-grade steel lever and plastic roller 13 mm

Snap-action contacts	1 NO + 2 NC	--	⊕	5	3SE5232-0LE12		1	1 unit
----------------------	-------------	----	---	---	---------------	--	---	--------

Angular roller lever

With metal lever and plastic roller 13 mm

Slow-action contacts	1 NO + 1 NC	--	⊕	5	3SE5232-0BF10		1	1 unit
Snap-action contacts, integrated ³⁾	1 NO + 1 NC	--	⊕	2	3SE5232-0HF10		1	1 unit
Slow-action contacts	1 NO + 2 NC	--	⊕	5	3SE5232-0KF10		1	1 unit
Snap-action contacts	1 NO + 2 NC	--	⊕	5	3SE5232-0LF10		1	1 unit



3SE5232-0BF10

⊕ Positive opening according to IEC 60947-5-1, Appendix K.

¹⁾ A cable gland with seal must be used with the quick-connect method.

²⁾ Popular versions.

³⁾ Subsequent replacement of contact blocks is not possible.

⁴⁾ The 3SE5234-.....-1AE2 position switches, prewired with an M12 plug, 5-pole, have the same pin assignment as all compact block I/O modules with a PROFINET connection in the SIMATIC ET 200eco PN, ET 200eco PN-F and ET 200AL series with IP65/IP67 degree of protection for cabinet-free installation directly at the machine.

SIRIUS 3SE5 Mechanical Position Switches







3SE5, Plastic Enclosures

Enclosure width 31 mm according to EN 50047

2 or 3 contacts · Degree of protection IP65 · Cable entry M20 × 1.5¹⁾

Version	Contacts	LEDs	SD	Complete units	<input type="checkbox"/>	PU (UNIT, SET, M)	PS*
			d	Article No.	Price per PU		

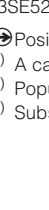
Complete units²⁾ · Enclosure width 31 mm

	Spring rod						
	Length 142.5 mm, with plastic plunger 50 mm						
	Snap-action contacts, integrated ³⁾	1 NO + 1 NC --		2	3SE5232-0HR01		1 1 unit
	With M12 device plug, 4-pole (250 V, 4 A)						
	Snap-action contacts, integrated ³⁾	1 NO + 1 NC --		5	3SE5234-0HR01-1AC4		1 1 unit
	Twist levers, type A, acc. to EN 50047						
	With metal lever 21 mm and plastic roller 19 mm						
	Slow-action contacts	1 NO + 1 NC --	↻	2	3SE5232-0BK21		1 1 unit
	Snap-action contacts, integrated ³⁾	1 NO + 1 NC --	↻	5	3SE5232-0HK21		1 1 unit
	Slow-action contacts	1 NO + 2 NC --	↻	5	3SE5232-0KK21		1 1 unit
	Snap-action contacts	1 NO + 2 NC --	↻	5	3SE5232-0LK21		1 1 unit
	With M12 device plug, 4-pole (250 V, 4 A)						
	Snap-action contacts, integrated ³⁾	1 NO + 1 NC --	↻	5	3SE5234-0HK21-1AC4		1 1 unit
	With metal lever 35 mm and plastic roller 19 mm						
	With metal lever 35 mm and plastic roller 19 mm						
	Snap-action contacts, integrated ³⁾	1 NO + 1 NC --	↻	5	3SE5232-0HK15		1 1 unit
	Twist levers, adjustable length						
	With metal lever with grid hole and plastic roller 19 mm						
	Snap-action contacts, integrated ³⁾	1 NO + 1 NC --	↻	2	3SE5232-0HK60		1 1 unit
	With metal lever and plastic roller 19 mm						
	Slow-action contacts	1 NO + 1 NC --		5	3SE5232-0BK50		1 1 unit
	Snap-action contacts, integrated ³⁾	1 NO + 1 NC --	▶		3SE5232-0HK50		1 1 unit
	Snap-action contacts	1 NO + 2 NC --		5	3SE5232-0LK50		1 1 unit
	With M12 device plug, 4-pole (250 V, 4 A)						
Snap-action contacts, integrated ³⁾	1 NO + 1 NC --		5	3SE5234-0HK50-1AC4		1 1 unit	
	Rod actuator						
	With aluminum rod, length 200 mm						
	Snap-action contacts, integrated ³⁾	1 NO + 1 NC --		5	3SE5232-0HK80		1 1 unit
	With plastic rod, length 200 mm						
	Snap-action contacts, integrated ³⁾	1 NO + 1 NC --		5	3SE5232-0HK82		1 1 unit
	With M12 device plug, 4-pole (250 V, 4 A)						
	Snap-action contacts, integrated ³⁾	1 NO + 1 NC --		5	3SE5234-0HK82-1AC4		1 1 unit

↻ Positive opening according to IEC 60947-5-1, Appendix K.

¹⁾ A cable gland with seal must be used with the quick-connect method.

²⁾ Popular versions.

³⁾ Subsequent replacement of contact blocks is not possible.

Note:

If the device you require is not available as a complete unit, see [Modular system, page 13/18](#).

SIRIUS 3SE5 Mechanical Position Switches

3SE5, Plastic Enclosures

Enclosure width 31 mm according to EN 50047

Modular system

2 or 3 contacts · Degree of protection IP65 · Cable entry M20 × 1.5¹⁾

Version	Contacts	LEDs	SD	Modular system	PU (UNIT, SET, M)	PS*
			d	Article No.	Price per PU	

Basic switches · Enclosure width 31 mm (with rounded plunger²⁾)

Teflon plungers



3SE5232-0BC05

Slow-action contacts	1 NO + 1 NC	--	⊕ ▶	5	3SE5232-0BC05	1	1 unit
Snap-action contacts	1 NO + 1 NC	--	⊕	5	3SE5232-0CC05	1	1 unit
Snap-action contacts, integrated ³⁾	1 NO + 1 NC	--	⊕ ▶	5	3SE5232-0HC05	1	1 unit
Snap-action contacts • Short stroke, integrated ³⁾	1 NO + 1 NC	--	⊕	5	3SE5232-0FC05	1	1 unit
Snap-action contacts • 2 × 2 mm contact gap	1 NO + 1 NC	--	⊕	15	3SE5232-0GC05	1	1 unit
Slow-action contacts	1 NO + 2 NC	--	⊕ ▶	5	3SE5232-0KC05	1	1 unit
Snap-action contacts	1 NO + 2 NC	--	⊕ ▶	5	3SE5232-0LC05	1	1 unit
Slow-action contacts with make-before-break	1 NO + 2 NC	--	⊕	2	3SE5232-0MC05	1	1 unit
Slow-action contacts	2 NO + 1 NC	--	⊕	2	3SE5232-0PC05	1	1 unit

Increased corrosion protection⁴⁾



3SE5232-0BC05-1CA0

Slow-action contacts	1 NO + 1 NC	--	⊕	5	3SE5232-0BC05-1CA0	1	1 unit
Snap-action contacts	1 NO + 1 NC	--	⊕	5	3SE5232-0CC05-1CA0	1	1 unit
Slow-action contacts	1 NO + 2 NC	--	⊕	5	3SE5232-0KC05-1CA0	1	1 unit
Snap-action contacts	1 NO + 2 NC	--	⊕	5	3SE5232-0LC05-1CA0	1	1 unit
Slow-action contacts with make-before-break	1 NO + 2 NC	--	⊕	5	3SE5232-0MC05-1CA0	1	1 unit
Slow-action contacts	2 NO + 1 NC	--	⊕	5	3SE5232-0PC05-1CA0	1	1 unit

M12 device plug, 4-pole (250 V, 4 A)



3SE5234-0HC05-1AC4

Slow-action contacts	1 NO + 1 NC	--	⊕	5	3SE5234-0BC05-1AC4	1	1 unit
Snap-action contacts, integrated ³⁾	1 NO + 1 NC	--	⊕	2	3SE5234-0HC05-1AC4	1	1 unit
Slow-action contacts	2 NC	--	⊕	5	3SE5234-0KC05-1AE0	1	1 unit
Snap-action contacts	2 NC	--	⊕	2	3SE5234-0LC05-1AE0	1	1 unit

2 LEDs yellow/green



3SE5232-1KC05

Slow-action contacts	1 NO + 2 NC	24 V DC	⊕	5	3SE5232-1KC05	1	1 unit
Snap-action contacts	1 NO + 2 NC	24 V DC	⊕	5	3SE5232-1LC05	1	1 unit
Slow-action contacts	1 NO + 2 NC	230 V AC	⊕	5	3SE5232-3KC05	1	1 unit
Snap-action contacts	1 NO + 2 NC	230 V AC	⊕	5	3SE5232-3LC05	1	1 unit

M12 device plug, 5-pole (125 V, 4 A), and 2 LEDs



3SE5234-1BC05-1AF3

Slow-action contacts	1 NO + 1 NC	24 V DC	⊕	5	3SE5234-1BC05-1AF3	1	1 unit
Snap-action contacts	1 NO + 1 NC	24 V DC	⊕	5	3SE5234-1CC05-1AF3	1	1 unit

With M12 device plug, 5-pole (125 V, 4 A), with pin assignment as for SIMATIC ET 200⁵⁾ **NEW**

Snap-action contacts	1 NO + 2 NC	24 V DC	⊕	X	3SE5234-0LC05-1AE2	1	1 unit
----------------------	-------------	---------	---	---	---------------------------	---	--------

⊕ Positive opening according to IEC 60947-5-1, Appendix K, or positively driven actuator, necessary in safety circuits.

- 1) A cable gland with seal must be used with the quick-connect method.
- 2) For enclosures with widths of 31 mm, the basic switch is a complete unit with rounded plungers.
- 3) Subsequent replacement of contact blocks is not possible.
- 4) Use corresponding high-grade steel lever.

⁵⁾ The 3SE5234-.....-1AE2 position switches, prewired with an M12 plug, 5-pole, have the same pin assignment as all compact block I/O modules with a PROFINET connection in the SIMATIC ET 200eco PN, ET 200eco PN-F and ET 200AL series with IP65/IP67 degree of protection for cabinet-free installation directly at the machine.











Note:

For the selection aid, see page 13/13

SIRIUS 3SE5 Mechanical Position Switches

3SE5, Plastic Enclosures

Enclosure width 31 mm according to EN 50047

Version	Diameter	SD	Modular system	PU (UNIT, SET, M)	PS*
	mm	d	Article No.	Price per PU	
Roller plungers, type C, acc. to EN 50047					
	Plastic rollers	10	⊕ 2	3SE5000-0AD03	1 1 unit
	High-grade steel rollers	10	⊕ 5	3SE5000-0AD04	1 1 unit
3SE5000-0AD03					
Roller plungers with central fixing					
	Plastic rollers	10	⊕ 2	3SE5000-0AD10	1 1 unit
	High-grade steel rollers	10	⊕ 5	3SE5000-0AD11	1 1 unit
3SE5000-0AD10					
Roller levers, type E, acc. to EN 50047					
	Metal lever, plastic roller	13	⊕ 2	3SE5000-0AE10	1 1 unit
	Metal lever, high-grade steel roller	13	⊕ 5	3SE5000-0AE11	1 1 unit
	High-grade steel lever, plastic roller	13	⊕ 5	3SE5000-0AE12	1 1 unit
	High-grade steel lever, high-grade steel roller	13	⊕ 5	3SE5000-0AE13	1 1 unit
3SE5000-0AE10					
Angular roller levers					
	Metal lever, plastic roller	13	⊕ 2	3SE5000-0AF10	1 1 unit
	Metal lever, high-grade steel roller	13	⊕ 5	3SE5000-0AF11	1 1 unit
	High-grade steel lever, plastic roller	13	⊕ 2	3SE5000-0AF12	1 1 unit
	High-grade steel lever, high-grade steel roller	13	⊕ 5	3SE5000-0AF13	1 1 unit
3SE5000-0AF10					
Spring rods					
(for switches with snap-action contacts only)					
	Plunger made of plastic, spring of high-grade steel:	7			
	• Length 142.5 mm (spring 50 mm, plunger 50 mm)		5	3SE5000-0AR01	1 1 unit
	• Length 76 mm (spring 23.5 mm, plunger 10 mm)		5	3SE5000-0AR03	1 1 unit
	• Length 242.5 mm (spring 150 mm, plunger 50 mm)		5	3SE5000-0AR04	1 1 unit
	Plunger and spring made of high-grade steel:	7			
• Length 142.5 mm (spring 50 mm, plunger 50 mm)		5	3SE5000-0AR02	1 1 unit	
3SE5000-0AR01					
Twist actuators, for 31 mm/50 mm, EN 50047					
	Switching right and/or left, adjustable		⊕ 2	3SE5000-0AK00	1 1 unit
3SE5000-0AK00					
Levers					
Twist levers 21 mm, straight, type A acc. to EN 50047					
	Metal lever, plastic roller	19	⊕ 2	3SE5000-0AA21	1 1 unit
	Metal lever, high-grade steel roller	19	⊕ 5	3SE5000-0AA22	1 1 unit
	Metal lever, high-grade steel roller with ball bearing	19	⊕ 5	3SE5000-0AA23	1 1 unit
	Metal lever, plastic roller	30	⊕ 5	3SE5000-0AA25	1 1 unit
	High-grade steel lever, plastic roller	19	⊕ 5	3SE5000-0AA31	1 1 unit
	High-grade steel lever, high-grade steel roller	19	⊕ 5	3SE5000-0AA32	1 1 unit
3SE5000-0AA21					
Twist levers 30 mm, straight					
	Metal lever, plastic roller	19	⊕ 5	3SE5000-0AA24	1 1 unit
	Metal lever, plastic roller	30	⊕ 5	3SE5000-0AA26	1 1 unit
Twist levers, adjustable length, with grid hole					
	Metal lever, plastic roller	19	⊕ 5	3SE5000-0AA60	1 1 unit
	Metal lever, high-grade steel roller	19	⊕ 5	3SE5000-0AA61	1 1 unit
	Metal lever, plastic roller	50	⊕ 5	3SE5000-0AA67	1 1 unit
	Metal lever, rubber roller	50	⊕ 5	3SE5000-0AA68	1 1 unit
	High-grade steel lever, plastic roller	19	⊕ 5	3SE5000-0AA62	1 1 unit
	High-grade steel lever, high-grade steel roller	19	⊕ 5	3SE5000-0AA63	1 1 unit
3SE5000-0AA60 3SE5000-0AA50					
Twist levers, adjustable length					
	Metal lever, plastic roller	19	2	3SE5000-0AA50	1 1 unit
	Metal lever, high-grade steel roller	19	5	3SE5000-0AA51	1 1 unit
	Metal lever, plastic roller	30	5	3SE5000-0AA55	1 1 unit
	Metal lever, plastic roller	50	5	3SE5000-0AA57	1 1 unit
	Metal lever, rubber roller	50	5	3SE5000-0AA58	1 1 unit
	High-grade steel lever, plastic roller	19	5	3SE5000-0AA52	1 1 unit
	High-grade steel lever, high-grade steel roller	19	5	3SE5000-0AA53	1 1 unit
	Rod actuator				
	Aluminum rod, length 200 mm	6	5	3SE5000-0AA80	1 1 unit
	Spring rod, length 200 mm	6	5	3SE5000-0AA81	1 1 unit
	Plastic rod, length 200 mm	6	5	3SE5000-0AA82	1 1 unit
3SE5000-0AA80					

⊕ Positively driven actuator, necessary in safety circuits.

SIRIUS 3SE5 Mechanical Position Switches

3SE5, Plastic Enclosures

Enclosure width 40 mm according to EN 50041

Selection and ordering data

Complete units

2 or 3 contacts · Degree of protection IP66/IP67 · Cable entry M20 × 1.5

Version	Contacts	LEDs	SD	Complete units	Price per PU	PU (UNIT, SET, M)	PS*
			d	Article No.			

Complete units¹⁾ · Enclosure width 40 mm

 <p>3SE5132-0BB01</p>	Plain plungers						
	With high-grade steel plunger						
	Slow-action contacts	1 NO + 1 NC --	⊕ 5	3SE5132-0BB01		1	1 unit
	Snap-action contacts	1 NO + 1 NC --	⊕ 5	3SE5132-0CB01		1	1 unit
	Slow-action contacts	1 NO + 2 NC --	⊕ 5	3SE5132-0KB01		1	1 unit
	Snap-action contacts	1 NO + 2 NC --	⊕ 5	3SE5132-0LB01		1	1 unit
	Slow-action contacts	2 NO + 1 NC --	⊕ 5	3SE5132-0PB01		1	1 unit
 <p>3SE5132-0BC03</p>	Rounded plungers, type B, acc. to EN 50041						
	With plastic plunger						
	Slow-action contacts	1 NO + 1 NC --	⊕ 5	3SE5132-0BC03		1	1 unit
	Snap-action contacts	1 NO + 1 NC --	⊕ 2	3SE5132-0CC03		1	1 unit
	Slow-action contacts	1 NO + 2 NC --	⊕ 5	3SE5132-0KC03		1	1 unit
	Snap-action contacts	1 NO + 2 NC --	⊕ 5	3SE5132-0LC03		1	1 unit
	Slow-action contacts	2 NO + 1 NC --	⊕ 5	3SE5132-0PC03		1	1 unit
 <p>3SE5132-0BD05</p>	Roller plungers, type C, acc. to EN 50041						
	With plastic roller 13 mm						
	Slow-action contacts	1 NO + 1 NC --	⊕ 5	3SE5132-0BD05		1	1 unit
	Snap-action contacts	1 NO + 1 NC --	⊕ 2	3SE5132-0CD05		1	1 unit
	Slow-action contacts	1 NO + 2 NC --	⊕ 5	3SE5132-0KD05		1	1 unit
	Snap-action contacts	1 NO + 2 NC --	⊕ 5	3SE5132-0LD05		1	1 unit
	Slow-action contacts	2 NO + 1 NC --	⊕ 5	3SE5132-0PD05		1	1 unit
 <p>3SE5132-0BE05</p>	Roller levers						
	With metal lever and plastic roller 22 mm						
	Slow-action contacts	1 NO + 1 NC --	⊕ 5	3SE5132-0BE05		1	1 unit
	Snap-action contacts	1 NO + 1 NC --	⊕ 2	3SE5132-0CE05		1	1 unit
	Slow-action contacts	1 NO + 2 NC --	⊕ 5	3SE5132-0KE05		1	1 unit
	Snap-action contacts	1 NO + 2 NC --	⊕ 5	3SE5132-0LE05		1	1 unit
	Slow-action contacts	2 NO + 1 NC --	⊕ 5	3SE5132-0PE05		1	1 unit
 <p>3SE5132-0BF05</p>	Angular roller lever						
	With metal lever and plastic roller 22 mm						
	Slow-action contacts	1 NO + 1 NC --	⊕ 5	3SE5132-0BF05		1	1 unit
	Snap-action contacts	1 NO + 1 NC --	⊕ 5	3SE5132-0CF05		1	1 unit
	Snap-action contacts	1 NO + 2 NC --	⊕ 5	3SE5132-0LF05		1	1 unit
 <p>3SE5132-0CR01</p>	Spring rod						
	Length 142.5 mm, with plastic plunger 50 mm						
	Snap-action contacts	1 NO + 1 NC --	5	3SE5132-0CR01		1	1 unit
	Snap-action contacts	1 NO + 2 NC --	5	3SE5132-0LR01		1	1 unit

⊕ Positive opening according to IEC 60947-5-1, Appendix K.

¹⁾ Popular versions.

SIRIUS 3SE5 Mechanical Position Switches

3SE5, Plastic Enclosures

Enclosure width 40 mm according to EN 50041

2 or 3 contacts · Degree of protection IP66/IP67 · Cable entry M20 × 1.5

Version	Contacts	LEDs	SD	Complete units	<input type="checkbox"/>	PU (UNIT, SET, M)	PS*
			d	Article No.	Price per PU		

Complete units¹⁾ · Enclosure width 40 mm



3SE5132-0BJ01

Twist levers, type A, acc. to EN 50041

With metal lever 27 mm and plastic roller 19 mm

Slow-action contacts	1 NO + 1 NC --	↻	2	3SE5132-0BJ01		1	1 unit
Snap-action contacts	1 NO + 1 NC --	↻	2	3SE5132-0CJ01		1	1 unit
Slow-action contacts	1 NO + 2 NC --	↻	5	3SE5132-0KJ01		1	1 unit
Snap-action contacts	1 NO + 2 NC --	↻	5	3SE5132-0LJ01		1	1 unit
Slow-action contacts	2 NO + 1 NC --	↻	5	3SE5132-0PJ01		1	1 unit



3SE5132-0CJ60

Twist levers, adjustable length

With metal lever with grid hole and plastic roller 19 mm

Snap-action contacts	1 NO + 1 NC --	↻	5	3SE5132-0CJ60		1	1 unit
Snap-action contacts	1 NO + 2 NC --	↻	5	3SE5132-0LJ60		1	1 unit



3SE5132-0CJ50

With metal lever and plastic roller 19 mm

Snap-action contacts	1 NO + 1 NC --		2	3SE5132-0CJ50		1	1 unit
Snap-action contacts	1 NO + 2 NC --		5	3SE5132-0LJ50		1	1 unit



3SE5132-0CJ80

Rod actuators, type D, acc. to EN 50041

With aluminum rod, length 200 mm

Snap-action contacts	1 NO + 1 NC --		5	3SE5132-0CJ80		1	1 unit
----------------------	----------------	--	---	---------------	--	---	--------

With plastic rod, length 200 mm

Snap-action contacts	1 NO + 1 NC --		2	3SE5132-0CJ82		1	1 unit
----------------------	----------------	--	---	---------------	--	---	--------

↻ Positive opening according to IEC 60947-5-1, Appendix K.

¹⁾ Popular versions.

Note:

If the device you require is not available as a complete unit, see [Modular system, page 13/22](#).

SIRIUS 3SE5 Mechanical Position Switches





3SE5, Plastic Enclosures

Enclosure width 40 mm according to EN 50041

Modular system

2 or 3 contacts · Degree of protection IP66/IP67 · Cable entry M20 × 1.5

Version	Contacts	LEDs	SD	Modular system	Price per PU	PU (UNIT, SET, M)	PS*
			d	Article No.			

Basic switches • Enclosure width 40 mm							
	Connecting thread M20 × 1.5						
	Slow-action contacts	1 NO + 1 NC	--	⊕ 5	3SE5132-0BA00		1 1 unit
	Snap-action contacts	1 NO + 1 NC	--	⊕ 5	3SE5132-0CA00		1 1 unit
	• Gold-plated contacts			⊕ 5	3SE5132-0CA00-1AC1		1 1 unit
	Slow-action contacts	1 NO + 2 NC	--	⊕ 5	3SE5132-0KA00		1 1 unit
	Snap-action contacts	1 NO + 2 NC	--	⊕ 5	3SE5132-0LA00		1 1 unit
	Slow-action contacts with make-before-break	1 NO + 2 NC	--	⊕ 5	3SE5132-0MA00		1 1 unit
3SE5132-0BA00	Slow-action contacts	2 NO + 1 NC	--	⊕ 5	3SE5132-0PA00		1 1 unit
	Increased corrosion protection¹⁾						
	Slow-action contacts	1 NO + 1 NC	--	⊕ 5	3SE5132-0BA00-1CA0		1 1 unit
	Snap-action contacts	1 NO + 1 NC	--	⊕ 5	3SE5132-0CA00-1CA0		1 1 unit
	Slow-action contacts	1 NO + 2 NC	--	⊕ 5	3SE5132-0KA00-1CA0		1 1 unit
	Snap-action contacts	1 NO + 2 NC	--	⊕ 5	3SE5132-0LA00-1CA0		1 1 unit
	Slow-action contacts with make-before-break	1 NO + 2 NC	--	⊕ 5	3SE5132-0MA00-1CA0		1 1 unit
	3SE5132-0BA00-1CA0	Slow-action contacts	2 NO + 1 NC	--	⊕ 5	3SE5132-0PA00-1CA0	
	M12 device plug, 4-pole (250 V, 4 A)						
	Slow-action contacts	1 NO + 1 NC	--	⊕ 5	3SE5134-0BA00-1AC4		1 1 unit
	Snap-action contacts	1 NO + 1 NC	--	⊕ 5	3SE5134-0CA00-1AC4		1 1 unit
	Slow-action contacts	2 NC	--	⊕ 5	3SE5134-0KA00-1AE0		1 1 unit
	Snap-action contacts	2 NC	--	⊕ 5	3SE5134-0LA00-1AE0		1 1 unit
3SE5134-0BA00-1AC4							
	2 LEDs, yellow/green						
	Slow-action contacts	1 NO + 2 NC	24 V DC	⊕ 5	3SE5132-1KA00		1 1 unit
	Snap-action contacts	1 NO + 2 NC	24 V DC	⊕ 5	3SE5132-1LA00		1 1 unit
	Slow-action contacts	1 NO + 2 NC	230 V AC	⊕ 5	3SE5132-3KA00		1 1 unit
	Snap-action contacts	1 NO + 2 NC	230 V AC	⊕ 5	3SE5132-3LA00		1 1 unit
3SE5132-1KA00							

⊕ Positive opening according to IEC 60947-5-1, Appendix K, or positively driven actuator, necessary in safety circuits.

¹⁾ Use corresponding high-grade steel lever.











Note:

For the selection aid, [see page 13/13](#)

SIRIUS 3SE5 Mechanical Position Switches

3SE5, Plastic Enclosures

Enclosure width 40 mm according to EN 50041

Version	Diameter	SD	Modular system	PU (UNIT, SET, M)	PS*
	mm	d	Article No.	Price per PU	
Operating mechanisms					
 3SE5000-0AB01	Plain plungers High-grade steel plunger	10	⊕ 2	3SE5000-0AB01	1 1 unit
 3SE5000-0AC03	Rounded plungers, type B, acc. to EN 50041 Plastic plungers	10	⊕ 5	3SE5000-0AC03	1 1 unit
 3SE5000-0AD05	Roller plungers, type C, acc. to EN 50041 Plastic plunger, plastic roller Plastic plunger, high-grade steel roller	13 13	⊕ 5 ⊕ 5	3SE5000-0AD05 3SE5000-0AD06	1 1 unit 1 1 unit
 3SE5000-0AE05	Roller levers Metal lever with plastic roller, plastic base	22	⊕ 5	3SE5000-0AE05	1 1 unit
 3SE5000-0AF05	Angular roller levers Metal lever with plastic roller, plastic base	22	⊕ 5	3SE5000-0AF05	1 1 unit
 3SE5000-0AR01	Spring rods (for switches with snap-action contacts only) Plunger made of plastic, spring of high-grade steel: • Length 142.5 mm (spring 50 mm, plunger 50 mm) • Length 76 mm (spring 23.5 mm, plunger 10 mm) • Length 242.5 mm (spring 150 mm, plunger 50 mm) Plunger and spring made of high-grade steel: • Length 142.5 mm (spring 50 mm, plunger 50 mm)	7 7	5 5 5 5	3SE5000-0AR01 3SE5000-0AR03 3SE5000-0AR04 3SE5000-0AR02	1 1 unit 1 1 unit 1 1 unit 1 1 unit
Twist actuators					
 3SE5000-0AH00	Twist actuators, for 40 mm, EN 50041 • For twist levers and rod actuators, switching right and/or left, adjustable		⊕ 2	3SE5000-0AH00	1 1 unit
Levers					
 3SE5000-0AA01	Twist levers, offset, type A, acc. to EN 50041 Metal lever 27 mm, plastic roller Metal lever 27 mm, high-grade steel roller Metal lever 27 mm, high-grade steel roller with ball bearing Metal lever 27 mm, 2 plastic rollers Metal lever 27 mm, plastic roller Metal lever 27 mm, rubber roller	19 19 19 19 30 50	⊕ 2 ⊕ 2 ⊕ 5 ⊕ 5 ⊕ 5 ⊕ 5	3SE5000-0AA01 3SE5000-0AA02 3SE5000-0AA03 3SE5000-0AA04 3SE5000-0AA05 3SE5000-0AA08	1 1 unit 1 1 unit 1 1 unit 1 1 unit 1 1 unit 1 1 unit
 3SE5000-0AA11	High-grade steel lever 27 mm, plastic roller High-grade steel lever 27 mm, high-grade steel roller Metal lever 35 mm, plastic roller High-grade steel lever 35 mm, plastic roller	19 19 19 19	⊕ 5 ⊕ 5 ⊕ 5 ⊕ 5	3SE5000-0AA11 3SE5000-0AA12 3SE5000-0AA15 3SE5000-0AA16	1 1 unit 1 1 unit 1 1 unit 1 1 unit
 3SE5000-0AA24	Twist levers 30 mm, straight Metal lever, plastic roller Metal lever, plastic roller	19 30	⊕ 5 ⊕ 5	3SE5000-0AA24 3SE5000-0AA26	1 1 unit 1 1 unit
 3SE5000-0AA60	Twist levers, adjustable length, with grid hole Metal lever, plastic roller Metal lever, high-grade steel roller Metal lever, rubber roller High-grade steel lever, plastic roller High-grade steel lever, high-grade steel roller	19 19 50 19 19	⊕ 5 ⊕ 5 ⊕ 5 ⊕ 5 ⊕ 5	3SE5000-0AA60 3SE5000-0AA61 3SE5000-0AA68 3SE5000-0AA62 3SE5000-0AA63	1 1 unit 1 1 unit 1 1 unit 1 1 unit 1 1 unit
 3SE5000-0AA80	Twist levers, adjustable length Metal lever, plastic roller Metal lever, high-grade steel roller Metal lever, plastic roller Metal lever, rubber roller High-grade steel lever, plastic roller High-grade steel lever, high-grade steel roller	19 19 30 50 19 19	2 5 5 5 5 5	3SE5000-0AA50 3SE5000-0AA51 3SE5000-0AA55 3SE5000-0AA58 3SE5000-0AA52 3SE5000-0AA53	1 1 unit 1 1 unit 1 1 unit 1 1 unit 1 1 unit 1 1 unit
 3SE5000-0AA80	Rod actuators, type D, acc. to EN 50041 Aluminum rod, length 200 mm Spring rod, length 200 mm Plastic rod, length 200 mm	6 6 6	5 5 5	3SE5000-0AA80 3SE5000-0AA81 3SE5000-0AA82	1 1 unit 1 1 unit 1 1 unit

⊕ Positively driven actuator, necessary in safety circuits.

SIRIUS 3SE5 Mechanical Position Switches

3SE5, Plastic Enclosures

Enclosure width 50 mm

Selection and ordering data

Complete units

2 or 3 contacts · Degree of protection IP66/IP67 · Cable entry 2 × (M20 × 1.5)

Version	Contacts	LEDs	SD	Complete units	PU (UNIT, SET, M)	PS*
			d	Article No.	Price per PU	

Complete units¹⁾ · Enclosure width 50 mm

Rounded plungers

With teflon plunger



3SE5242-0BC05

Slow-action contacts	1 NO + 1 NC	--	⊕ 2	3SE5242-0BC05		1 1 unit
Snap-action contacts	1 NO + 1 NC	--	⊕ 5	3SE5242-0CC05		1 1 unit
Snap-action contacts, integrated ²⁾	1 NO + 1 NC	--	⊕ ▶	3SE5242-0HC05		1 1 unit
Snap-action contacts • Short stroke, integrated ²⁾	1 NO + 1 NC	--	⊕ 15	3SE5242-0FC05		1 1 unit
Snap-action contacts • 2 × 2 mm contact gap	1 NO + 1 NC	--	⊕ 30	3SE5242-0GC05		1 1 unit
Slow-action contacts	1 NO + 2 NC	--	⊕ 5	3SE5242-0KC05		1 1 unit
Snap-action contacts	1 NO + 2 NC	--	⊕ 5	3SE5242-0LC05		1 1 unit
Slow-action contacts with make-before-break	1 NO + 2 NC	--	⊕ 5	3SE5242-0MC05		1 1 unit
Slow-action contacts	2 NO + 1 NC	--	⊕ 2	3SE5242-0PC05		1 1 unit

With increased corrosion protection



3SE5242-0BC05-1CA0

Slow-action contacts	1 NO + 1 NC	--	⊕ 5	3SE5242-0BC05-1CA0		1 1 unit
Snap-action contacts, integrated ²⁾	1 NO + 1 NC	--	⊕ 30	3SE5242-0HC05-1CA0		1 1 unit
Slow-action contacts	1 NO + 2 NC	--	⊕ 5	3SE5242-0KC05-1CA0		1 1 unit
Snap-action contacts	1 NO + 2 NC	--	⊕ 5	3SE5242-0LC05-1CA0		1 1 unit
Slow-action contacts with make-before-break	1 NO + 2 NC	--	⊕ 5	3SE5242-0MC05-1CA0		1 1 unit
Slow-action contacts	2 NO + 1 NC	--	⊕ 5	3SE5242-0PC05-1CA0		1 1 unit

With 2 LEDs, yellow/green



3SE5242-1KC05

Slow-action contacts	1 NO + 2 NC	24 V DC	⊕ 5	3SE5242-1KC05		1 1 unit
Snap-action contacts	1 NO + 2 NC	24 V DC	⊕ 5	3SE5242-1LC05		1 1 unit
Slow-action contacts	1 NO + 2 NC	230 V AC	⊕ 5	3SE5242-3KC05		1 1 unit
Snap-action contacts	1 NO + 2 NC	230 V AC	⊕ 5	3SE5242-3LC05		1 1 unit

Roller plunger

With plastic roller 10 mm



3SE5242-0BD03

Slow-action contacts	1 NO + 1 NC	--	⊕ 5	3SE5242-0BD03		1 1 unit
Snap-action contacts, integrated ²⁾	1 NO + 1 NC	--	⊕ 5	3SE5242-0HD03		1 1 unit
Snap-action contacts	1 NO + 2 NC	--	⊕ 5	3SE5242-0LD03		1 1 unit

⊕ Positive opening according to IEC 60947-5-1, Appendix K.

¹⁾ Popular versions.

²⁾ Subsequent replacement of contact blocks is not possible.

SIRIUS 3SE5 Mechanical Position Switches

3SE5, Plastic Enclosures

Enclosure width 50 mm

2 or 3 contacts · Degree of protection IP66/IP67 · Cable entry 2 × (M20 × 1.5)

Version	Contacts	LEDs	SD	Complete units	<input type="checkbox"/>	PU (UNIT, SET, M)	PS*
			d	Article No.	Price per PU		

Complete units¹⁾ · Enclosure width 50 mm



3SE5242-0BE10

Roller levers

With metal lever and plastic roller 13 mm

Slow-action contacts	1 NO + 1 NC	--	⊕ 5	3SE5242-0BE10		1	1 unit
Snap-action contacts, integrated ²⁾	1 NO + 1 NC	--	⊕ 2	3SE5242-0HE10		1	1 unit
Snap-action contacts	1 NO + 2 NC	--	⊕ 5	3SE5242-0LE10		1	1 unit

With M12 device plug, 4-pole right (250 V, 4 A)

Snap-action contacts	2 NC	--	⊕ 5	3SE5244-0LE10-1AE0		1	1 unit
----------------------	------	----	-----	---------------------------	--	---	--------



3SE5242-0BK21

Twist levers

With metal lever 21 mm and plastic roller 19 mm

Slow-action contacts	1 NO + 1 NC	--	⊕ 5	3SE5242-0BK21		1	1 unit
Snap-action contacts, integrated ²⁾	1 NO + 1 NC	--	⊕ 5	3SE5242-0HK21		1	1 unit
Snap-action contacts	1 NO + 2 NC	--	⊕ 5	3SE5242-0LK21		1	1 unit

Twist levers, adjustable length

With metal lever and plastic roller 19 mm

Snap-action contacts, integrated ²⁾	1 NO + 1 NC	--	5	3SE5242-0HK50		1	1 unit
--	-------------	----	---	----------------------	--	---	--------



3SE5242-0HK50

⊕ Positive opening according to IEC 60947-5-1, Appendix K.

¹⁾ Popular versions.

²⁾ Subsequent replacement of contact blocks is not possible.

Note:

If the device you require is not available as a complete unit, see [Modular system](#), page 13/26.

SIRIUS 3SE5 Mechanical Position Switches

3SE5, Plastic Enclosures

Enclosure width 50 mm

Modular system

2 or 3 contacts · Degree of protection IP66/IP67 · Cable entry 2 × (M20 × 1.5)

Version	Contacts	LEDs	SD	Modular system	PU (UNIT, SET, M)	PS*
			d	Article No.	Price per PU	

Basic switches • Enclosure width 50 mm (with rounded plunger¹⁾)



3SE5242-0BC05

Teflon plungers

Slow-action contacts	1 NO + 1 NC	--	⊕ 2	3SE5242-0BC05		1 1 unit
Snap-action contacts	1 NO + 1 NC	--	⊕ 5	3SE5242-0CC05		1 1 unit
Snap-action contacts, integrated ²⁾	1 NO + 1 NC	--	⊕ ▶	3SE5242-0HC05		1 1 unit
Snap-action contacts • Short stroke, integrated ²⁾	1 NO + 1 NC	--	⊕ 15	3SE5242-0FC05		1 1 unit
Snap-action contacts • 2 × 2 mm contact gap	1 NO + 1 NC	--	⊕ 30	3SE5242-0GC05		1 1 unit
Slow-action contacts	1 NO + 2 NC	--	⊕ 5	3SE5242-0KC05		1 1 unit
Snap-action contacts	1 NO + 2 NC	--	⊕ 5	3SE5242-0LC05		1 1 unit
Slow-action contacts with make-before-break	1 NO + 2 NC	--	⊕ 5	3SE5242-0MC05		1 1 unit
Slow-action contacts	2 NO + 1 NC	--	⊕ 2	3SE5242-0PC05		1 1 unit



3SE5242-0BC05-1CA0

Increased corrosion protection³⁾

Slow-action contacts	1 NO + 1 NC	--	⊕ 5	3SE5242-0BC05-1CA0		1 1 unit
Snap-action contacts, integrated ²⁾	1 NO + 1 NC	--	⊕ 30	3SE5242-0HC05-1CA0		1 1 unit
Slow-action contacts	1 NO + 2 NC	--	⊕ 5	3SE5242-0KC05-1CA0		1 1 unit
Snap-action contacts	1 NO + 2 NC	--	⊕ 5	3SE5242-0LC05-1CA0		1 1 unit
Slow-action contacts with make-before-break	1 NO + 2 NC	--	⊕ 5	3SE5242-0MC05-1CA0		1 1 unit
Slow-action contacts	2 NO + 1 NC	--	⊕ 5	3SE5242-0PC05-1CA0		1 1 unit



3SE5242-1KC05

2 LEDs yellow/green

Slow-action contacts	1 NO + 2 NC	24 V DC	⊕ 5	3SE5242-1KC05		1 1 unit
Snap-action contacts	1 NO + 2 NC	24 V DC	⊕ 5	3SE5242-1LC05		1 1 unit
Slow-action contacts	1 NO + 2 NC	230 V AC	⊕ 5	3SE5242-3KC05		1 1 unit
Snap-action contacts	1 NO + 2 NC	230 V AC	⊕ 5	3SE5242-3LC05		1 1 unit

⊕ Positive opening according to IEC 60947-5-1, Appendix K, or positively driven actuator, necessary in safety circuits.

¹⁾ For enclosures with widths of 50 mm, the basic switch is a complete unit with rounded plungers.

²⁾ Subsequent replacement of contact blocks is not possible.

³⁾ Use corresponding high-grade steel lever.

Note:

For the selection aid, see page 13/13

Version	Diameter	SD	Modular system	PU (UNIT, SET, M)	PS*
	mm	d	Article No.	Price per PU	

Operating mechanisms



3SE5000-0AD03

Roller plungers, type C, acc. to EN 50047

Plastic rollers	10	⊕ 2	3SE5000-0AD03		1 1 unit
High-grade steel rollers	10	⊕ 5	3SE5000-0AD04		1 1 unit



3SE5000-0AD10

Roller plungers with central fixing









Plastic rollers	10	⊕ 2	3SE5000-0AD10		1 1 unit
High-grade steel rollers	10	⊕ 5	3SE5000-0AD11		1 1 unit

⊕ Positively driven actuator, necessary in safety circuits.

SIRIUS 3SE5 Mechanical Position Switches

3SE5, Plastic Enclosures

Enclosure width 50 mm

Version	Diameter	SD	Modular system	PU (UNIT, SET, M)	PS*
	mm	d	Article No.	Price per PU	
Operating mechanisms					
 3SE5000-0AE10	Roller levers, type E, acc. to EN 50047				
	Metal lever, plastic roller	13	⊕ 2	3SE5000-0AE10	1 1 unit
	Metal lever, high-grade steel roller	13	⊕ 5	3SE5000-0AE11	1 1 unit
	High-grade steel lever, plastic roller	13	⊕ 5	3SE5000-0AE12	1 1 unit
 3SE5000-0AF10	Angular roller levers				
	Metal lever, plastic roller	13	⊕ 2	3SE5000-0AF10	1 1 unit
	Metal lever, high-grade steel roller	13	⊕ 5	3SE5000-0AF11	1 1 unit
	High-grade steel lever, plastic roller	13	⊕ 2	3SE5000-0AF12	1 1 unit
 3SE5000-0AR01	Spring rods (for switches with snap-action contacts only)				
	Plunger made of plastic, spring of high-grade steel:	7			
	• Length 142.5 mm (spring 50 mm, plunger 50 mm)		5	3SE5000-0AR01	1 1 unit
	• Length 76 mm (spring 23.5 mm, plunger 10 mm)		5	3SE5000-0AR03	1 1 unit
	• Length 242.5 mm (spring 150 mm, plunger 50 mm)		5	3SE5000-0AR04	1 1 unit
Plunger and spring made of high-grade steel:	7				
• Length 142.5 mm (spring 50 mm, plunger 50 mm)		5	3SE5000-0AR02	1 1 unit	
Twist actuators					
 3SE5000-0AK00	Twist actuators, for 31 mm/50 mm, EN 50047				
	Switching right and/or left, adjustable		⊕ 2	3SE5000-0AK00	1 1 unit
Levers					
 3SE5000-0AA21	Twist levers 21 mm, straight, type A acc. to EN 50047				
	Metal lever, plastic roller	19	⊕ 2	3SE5000-0AA21	1 1 unit
	Metal lever, high-grade steel roller	19	⊕ 5	3SE5000-0AA22	1 1 unit
	Metal lever, high-grade steel roller with ball bearing	19	⊕ 5	3SE5000-0AA23	1 1 unit
	Metal lever, plastic roller	30	⊕ 5	3SE5000-0AA25	1 1 unit
	High-grade steel lever, plastic roller	19	⊕ 5	3SE5000-0AA31	1 1 unit
 3SE5000-0AA60 3SE5000-0AA24	Twist levers 30 mm, straight				
	Metal lever, plastic roller	19	⊕ 5	3SE5000-0AA24	1 1 unit
 3SE5000-0AA60 3SE5000-0AA24	Twist levers, adjustable length, with grid hole				
	Metal lever, plastic roller	19	⊕ 5	3SE5000-0AA60	1 1 unit
	Metal lever, high-grade steel roller	19	⊕ 5	3SE5000-0AA61	1 1 unit
	Metal lever, plastic roller	50	⊕ 5	3SE5000-0AA67	1 1 unit
	Metal lever, rubber roller	50	⊕ 5	3SE5000-0AA68	1 1 unit
	High-grade steel lever, plastic roller	19	⊕ 5	3SE5000-0AA62	1 1 unit
	High-grade steel lever, high-grade steel roller	19	⊕ 5	3SE5000-0AA63	1 1 unit
 3SE5000-0AA50	Twist levers, adjustable length				
	Metal lever, plastic roller	19	2	3SE5000-0AA50	1 1 unit
	Metal lever, high-grade steel roller	19	5	3SE5000-0AA51	1 1 unit
	Metal lever, plastic roller	30	5	3SE5000-0AA55	1 1 unit
	Metal lever, plastic roller	50	5	3SE5000-0AA57	1 1 unit
	Metal lever, rubber roller	50	5	3SE5000-0AA58	1 1 unit
	High-grade steel lever, plastic roller	19	5	3SE5000-0AA52	1 1 unit
	High-grade steel lever, high-grade steel roller	19	5	3SE5000-0AA53	1 1 unit
Rod actuator					
Aluminum rod, length 200 mm	6	5	3SE5000-0AA80	1 1 unit	
Spring rod, length 200 mm	6	5	3SE5000-0AA81	1 1 unit	
Plastic rod, length 200 mm	6	5	3SE5000-0AA82	1 1 unit	

⊕ Positively driven actuator, necessary in safety circuits.

SIRIUS 3SE5 Mechanical Position Switches

3SE5, Metal Enclosures

Enclosure width 31 mm according to EN 50047

Selection and ordering data

Complete units

2 or 3 contacts · Degree of protection IP66/IP67 · Cable entry M20 × 1.5

Version	Contacts	LEDs	SD	Complete units	PU (UNIT, SET, M)	PS*
			d	Article No.	Price per PU	

Complete units¹⁾ · Enclosure width 31 mm

Rounded plungers, type B, acc. to EN 50047

With plunger

Slow-action contacts	1 NO + 1 NC --		⊕ 2	3SE5212-0BC05	1	1 unit
Snap-action contacts	1 NO + 1 NC --		⊕ 2	3SE5212-0CC05	1	1 unit
Slow-action contacts	1 NO + 2 NC --		⊕ 5	3SE5212-0KC05	1	1 unit
Snap-action contacts	1 NO + 2 NC --		⊕ 2	3SE5212-0LC05	1	1 unit
Slow-action contacts with make-before-break	1 NO + 2 NC --		⊕ 2	3SE5212-0MC05	1	1 unit
Slow-action contacts	2 NO + 1 NC --		⊕ 5	3SE5212-0PC05	1	1 unit

With increased corrosion protection

Slow-action contacts	1 NO + 1 NC --		⊕ 5	3SE5212-0BC05-1CA0	1	1 unit
Snap-action contacts	1 NO + 1 NC --		⊕ 5	3SE5212-0CC05-1CA0	1	1 unit
Slow-action contacts	1 NO + 2 NC --		⊕ 5	3SE5212-0KC05-1CA0	1	1 unit
Snap-action contacts	1 NO + 2 NC --		⊕ 5	3SE5212-0LC05-1CA0	1	1 unit
Slow-action contacts with make-before-break	1 NO + 2 NC --		⊕ 5	3SE5212-0MC05-1CA0	1	1 unit
Slow-action contacts	2 NO + 1 NC --		⊕ 5	3SE5212-0PC05-1CA0	1	1 unit

With M12 device plug, 5-pole (125 V, 4 A)

Slow-action contacts	1 NO + 1 NC --		⊕ 5	3SE5214-0BC05-1AC5	1	1 unit
Snap-action contacts	1 NO + 1 NC --		⊕ 5	3SE5214-0CC05-1AC5	1	1 unit
Slow-action contacts	2 NC --		⊕ 5	3SE5214-0KC05-1AE1	1	1 unit
Snap-action contacts	2 NC --		⊕ 5	3SE5214-0LC05-1AE1	1	1 unit

With 2 LEDs, yellow/green

Slow-action contacts	1 NO + 2 NC	24 V DC	⊕ 5	3SE5212-1KC05	1	1 unit
Snap-action contacts	1 NO + 2 NC	24 V DC	⊕ 2	3SE5212-1LC05	1	1 unit
Slow-action contacts	1 NO + 2 NC	230 V AC	⊕ 5	3SE5212-3KC05	1	1 unit
Snap-action contacts	1 NO + 2 NC	230 V AC	⊕ 5	3SE5212-3LC05	1	1 unit

With M12 device plug, 5-pole (125 V, 4 A), and 2 LEDs

Slow-action contacts	1 NO + 1 NC	24 V DC	⊕ 5	3SE5214-1BC05-1AF3	1	1 unit
Snap-action contacts	1 NO + 1 NC	24 V DC	⊕ 5	3SE5214-1CC05-1AF3	1	1 unit

Plain plungers

With high-grade steel plunger

Slow-action contacts	1 NO + 1 NC --		⊕ 5	3SE5212-0BB01	1	1 unit
Snap-action contacts	1 NO + 1 NC --		⊕ 5	3SE5212-0CB01	1	1 unit
Slow-action contacts	1 NO + 2 NC --		⊕ 5	3SE5212-0KB01	1	1 unit
Snap-action contacts	1 NO + 2 NC --		⊕ 5	3SE5212-0LB01	1	1 unit

Roller plungers, type C, acc. to EN 50047

With plastic roller 10 mm

Slow-action contacts	1 NO + 1 NC --		⊕ 2	3SE5212-0BD03	1	1 unit
Snap-action contacts	1 NO + 1 NC --		⊕ 5	3SE5212-0CD03	1	1 unit
Slow-action contacts	1 NO + 2 NC --		⊕ 5	3SE5212-0KD03	1	1 unit
Snap-action contacts	1 NO + 2 NC --		⊕ 5	3SE5212-0LD03	1	1 unit

LIMIT SWITCHES AND SAFETY 13



3SE5212-0BC05



3SE5212-0BC05-1CA0



3SE5212-1KC05



3SE5212-0BB01



3SE5212-0BD03

⊕ Positive opening according to IEC 60947-5-1, Appendix K.

¹⁾ Popular versions.

SIRIUS 3SE5 Mechanical Position Switches

3SE5, Metal Enclosures

Enclosure width 31 mm according to EN 50047

2 or 3 contacts · Degree of protection IP66/IP67 · Cable entry M20 × 1.5

Version	Contacts	LEDs	SD	Complete units	Price per PU	PU (UNIT, SET, M)	PS*
			d	Article No.			

Complete units¹⁾ · Enclosure width 31 mm



3SE5212-0KD10

Roller plungers with central fixing

With plastic roller 10 mm

Slow-action contacts	1 NO + 2 NC	--	⊕ 5	3SE5212-0KD10		1	1 unit
----------------------	-------------	----	-----	---------------	--	---	--------



3SE5212-0BE10

Roller levers, type E acc. to EN 50047

With metal lever and plastic roller 13 mm

Slow-action contacts	1 NO + 1 NC	--	⊕ 5	3SE5212-0BE10		1	1 unit
Snap-action contacts	1 NO + 1 NC	--	⊕ 5	3SE5212-0CE10		1	1 unit
Slow-action contacts	1 NO + 2 NC	--	⊕ 5	3SE5212-0KE10		1	1 unit
Snap-action contacts	1 NO + 2 NC	--	⊕ 5	3SE5212-0LE10		1	1 unit



3SE5212-0BF10

Angular roller lever

With metal lever and plastic roller 13 mm

Slow-action contacts	1 NO + 1 NC	--	⊕ 5	3SE5212-0BF10		1	1 unit
Snap-action contacts	1 NO + 1 NC	--	⊕ 5	3SE5212-0CF10		1	1 unit
Slow-action contacts	1 NO + 2 NC	--	⊕ 5	3SE5212-0KF10		1	1 unit
Snap-action contacts	1 NO + 2 NC	--	⊕ 5	3SE5212-0LF10		1	1 unit



3SE5212-0BK21

Twist levers, type A, acc. to EN 50047

With metal lever 21 mm and plastic roller 19 mm

Slow-action contacts	1 NO + 1 NC	--	⊕ 5	3SE5212-0BK21		1	1 unit
Snap-action contacts	1 NO + 1 NC	--	⊕ 5	3SE5212-0CK21		1	1 unit
Slow-action contacts	1 NO + 2 NC	--	⊕ 5	3SE5212-0KK21		1	1 unit
Snap-action contacts	1 NO + 2 NC	--	⊕ 5	3SE5212-0LK21		1	1 unit



3SE5212-0CK60

Twist levers, adjustable length

With metal lever with grid hole and plastic roller 19 mm

Snap-action contacts	1 NO + 1 NC	--	⊕ 5	3SE5212-0CK60		1	1 unit
Slow-action contacts	1 NO + 2 NC	--	⊕ 5	3SE5212-0KK60		1	1 unit
Snap-action contacts	1 NO + 2 NC	--	⊕ 5	3SE5212-0LK60		1	1 unit

With metal lever and plastic roller 19 mm

Slow-action contacts	1 NO + 1 NC	--	5	3SE5212-0BK50		1	1 unit
Snap-action contacts	1 NO + 1 NC	--	5	3SE5212-0CK50		1	1 unit
Snap-action contacts	1 NO + 2 NC	--	5	3SE5212-0LK50		1	1 unit

⊕ Positive opening according to IEC 60947-5-1, Appendix K.

¹⁾ Popular versions.

Note:

If the device you require is not available as a complete unit, see Modular system, page 13/30.

SIRIUS 3SE5 Mechanical Position Switches

3SE5, Metal Enclosures

Enclosure width 31 mm according to EN 50047

Modular system

2 or 3 contacts · Degree of protection IP66/IP67 · Cable entry M20 × 1.5

Version	Contacts	LEDs	SD	Modular system	PU (UNIT, SET, M)	PS*
			d	Article No.	Price per PU	

Basic switches · Enclosure width 31 mm (with rounded plunger¹⁾)



3SE5212-0BC05

Plunger

Slow-action contacts	1 NO + 1 NC	--	⊕ 2	3SE5212-0BC05	1	1 unit
Snap-action contacts	1 NO + 1 NC	--	⊕ 2	3SE5212-0CC05	1	1 unit
Slow-action contacts	1 NO + 2 NC	--	⊕ 5	3SE5212-0KC05	1	1 unit
Snap-action contacts	1 NO + 2 NC	--	⊕ 2	3SE5212-0LC05	1	1 unit
Slow-action contacts with make-before-break	1 NO + 2 NC	--	⊕ 2	3SE5212-0MC05	1	1 unit
Slow-action contacts	2 NO + 1 NC	--	⊕ 5	3SE5212-0PC05	1	1 unit



3SE5212-0BC05-1CA0

Increased corrosion protection²⁾

Slow-action contacts	1 NO + 1 NC	--	⊕ 5	3SE5212-0BC05-1CA0	1	1 unit
Snap-action contacts	1 NO + 1 NC	--	⊕ 5	3SE5212-0CC05-1CA0	1	1 unit
Slow-action contacts	1 NO + 2 NC	--	⊕ 5	3SE5212-0KC05-1CA0	1	1 unit
Snap-action contacts	1 NO + 2 NC	--	⊕ 5	3SE5212-0LC05-1CA0	1	1 unit
Slow-action contacts with make-before-break	1 NO + 2 NC	--	⊕ 5	3SE5212-0MC05-1CA0	1	1 unit
Slow-action contacts	2 NO + 1 NC	--	⊕ 5	3SE5212-0PC05-1CA0	1	1 unit



3SE5214-0BC05-1AC5

M12 device plug, 5-pole (125 V, 4 A)

Slow-action contacts	1 NO + 1 NC	--	⊕ 5	3SE5214-0BC05-1AC5	1	1 unit
Snap-action contacts	1 NO + 1 NC	--	⊕ 5	3SE5214-0CC05-1AC5	1	1 unit
Slow-action contacts	2 NC	--	⊕ 5	3SE5214-0KC05-1AE1	1	1 unit
Snap-action contacts	2 NC	--	⊕ 5	3SE5214-0LC05-1AE1	1	1 unit



3SE5212-1KC05

2 LEDs yellow/green

Slow-action contacts	1 NO + 2 NC	24 V DC	⊕ 5	3SE5212-1KC05	1	1 unit
Snap-action contacts	1 NO + 2 NC	24 V DC	⊕ 2	3SE5212-1LC05	1	1 unit
Slow-action contacts	1 NO + 2 NC	230 V AC	⊕ 5	3SE5212-3KC05	1	1 unit
Snap-action contacts	1 NO + 2 NC	230 V AC	⊕ 5	3SE5212-3LC05	1	1 unit



3SE5214-1BC05-1AF3

M12 device plug, 5-pole (125 V, 4 A), and 2 LEDs

Slow-action contacts	1 NO + 1 NC	24 V DC	⊕ 5	3SE5214-1BC05-1AF3	1	1 unit
Snap-action contacts	1 NO + 1 NC	24 V DC	⊕ 5	3SE5214-1CC05-1AF3	1	1 unit
Snap-action contacts	NEW 1 NO + 1 NC	24 V DC	⊕ 5	3SE5114-1CA00-1AF5	1	1 unit

⊕ Positive opening according to IEC 60947-5-1, Appendix K, or positively driven actuator, necessary in safety circuits.

¹⁾ For enclosures with widths of 31 mm, the basic switch is a complete unit with rounded plungers.

²⁾ Use corresponding high-grade steel lever.

Note:

For the selection aid, see page 13/13

Version	Diameter	SD	Modular system	PU (UNIT, SET, M)	PS*
	mm	d	Article No.	Price per PU	

Operating mechanisms



3SE5000-0AB01

Plain plungers

High-grade steel plunger	10	⊕ 2	3SE5000-0AB01	1	1 unit
--------------------------	----	-----	----------------------	---	--------



3SE5000-0AD03

Roller plungers, type C, acc. to EN 50047



Plastic rollers	10	⊕ 2	3SE5000-0AD03	1	1 unit
High-grade steel rollers	10	⊕ 5	3SE5000-0AD04	1	1 unit

⊕ Positively driven actuator, necessary in safety circuits.

SIRIUS 3SE5 Mechanical Position Switches

3SE5, Metal Enclosures

Enclosure width 31 mm according to EN 50047

Version	Diameter	SD	Modular system	PU (UNIT, SET, M)	PS*
	mm	d	Article No.	Price per PU	
Operating mechanisms					
 3SE5000-0AD10	Roller plungers with central fixing				
	Plastic rollers	10	↻ 2	3SE5000-0AD10	1 1 unit
	High-grade steel rollers	10	↻ 5	3SE5000-0AD11	1 1 unit
 3SE5000-0AE10	Roller levers, type E, acc. to EN 50047				
	Metal lever, plastic roller	13	↻ 2	3SE5000-0AE10	1 1 unit
	Metal lever, high-grade steel roller	13	↻ 5	3SE5000-0AE11	1 1 unit
	High-grade steel lever, plastic roller	13	↻ 5	3SE5000-0AE12	1 1 unit
	High-grade steel lever, high-grade steel roller	13	↻ 5	3SE5000-0AE13	1 1 unit
 3SE5000-0AF10	Angular roller levers				
	Metal lever, plastic roller	13	↻ 2	3SE5000-0AF10	1 1 unit
	Metal lever, high-grade steel roller	13	↻ 5	3SE5000-0AF11	1 1 unit
	High-grade steel lever, plastic roller	13	↻ 2	3SE5000-0AF12	1 1 unit
	High-grade steel lever, high-grade steel roller	13	↻ 5	3SE5000-0AF13	1 1 unit
 3SE5000-0AR01	Spring rods (for switches with snap-action contacts only) Plunger made of plastic, spring of high-grade steel:				
	• Length 142.5 mm (spring 50 mm, plunger 50 mm)	7	5	3SE5000-0AR01	1 1 unit
	• Length 76 mm (spring 23.5 mm, plunger 10 mm)		5	3SE5000-0AR03	1 1 unit
	• Length 242.5 mm (spring 150 mm, plunger 50 mm)		5	3SE5000-0AR04	1 1 unit
	Plunger and spring made of high-grade steel: • Length 142.5 mm (spring 50 mm, plunger 50 mm)	7	5	3SE5000-0AR02	1 1 unit
Twist actuators					
 3SE5000-0AK00	Twist actuators, for 31 mm/50 mm, EN 50047				
	Switching right and/or left, adjustable		↻ 2	3SE5000-0AK00	1 1 unit
 3SE5000-0AA21	Levers				
	Twist levers, straight, type A, acc. to EN 50047				
	Metal lever 21 mm, plastic roller	19	↻ 2	3SE5000-0AA21	1 1 unit
	Metal lever 21 mm, high-grade steel roller	19	↻ 5	3SE5000-0AA22	1 1 unit
	Metal lever 21 mm, high-grade steel roller with ball bearing	19	↻ 5	3SE5000-0AA23	1 1 unit
	Metal lever 21 mm, plastic roller	30	↻ 5	3SE5000-0AA25	1 1 unit
	High-grade steel lever 21 mm, plastic roller	19	↻ 5	3SE5000-0AA31	1 1 unit
	High-grade steel lever 21 mm, high-grade steel roller	19	↻ 5	3SE5000-0AA32	1 1 unit
	Twist levers 30 mm, straight				
	Metal lever, plastic roller	19	↻ 5	3SE5000-0AA24	1 1 unit
Metal lever, plastic roller	30	↻ 5	3SE5000-0AA26	1 1 unit	
 3SE5000-0AA60 3SE5000-0AA50	Twist levers, adjustable length, with grid hole				
	Metal lever, plastic roller	19	↻ 5	3SE5000-0AA60	1 1 unit
	Metal lever, high-grade steel roller	19	↻ 5	3SE5000-0AA61	1 1 unit
	Metal lever, plastic roller	50	↻ 5	3SE5000-0AA67	1 1 unit
	Metal lever, rubber roller	50	↻ 5	3SE5000-0AA68	1 1 unit
	High-grade steel lever, plastic roller	19	↻ 5	3SE5000-0AA62	1 1 unit
	High-grade steel lever, high-grade steel roller	19	↻ 5	3SE5000-0AA63	1 1 unit
Twist levers, adjustable length					
Metal lever, plastic roller	19	2	3SE5000-0AA50	1 1 unit	
Metal lever, high-grade steel roller	19	5	3SE5000-0AA51	1 1 unit	
Metal lever, plastic roller	30	5	3SE5000-0AA55	1 1 unit	
Metal lever, plastic roller	50	5	3SE5000-0AA57	1 1 unit	
Metal lever, rubber roller	50	5	3SE5000-0AA58	1 1 unit	
High-grade steel lever, plastic roller	19	5	3SE5000-0AA52	1 1 unit	
High-grade steel lever, high-grade steel roller	19	5	3SE5000-0AA53	1 1 unit	
 3SE5000-0AA80	Rod actuators, type D, acc. to EN 50041				
	Aluminum rod, length 200 mm	6	5	3SE5000-0AA80	1 1 unit
	Spring rod, length 200 mm	6	5	3SE5000-0AA81	1 1 unit
	Plastic rod, length 200 mm	6	5	3SE5000-0AA82	1 1 unit
	Plastic rod, length 330 mm	6	5	3SE5000-0AA83	1 1 unit

↻ Positively driven actuator, necessary in safety circuits.

SIRIUS 3SE5 Mechanical Position Switches

3SE5, Metal Enclosures

Enclosure width 40 mm according to EN 50041







Selection and ordering data

Complete units

2 or 3 contacts · Degree of protection IP66/IP67 · Cable entry M20 × 1.5

Version	Contacts	LEDs	SD	Complete units	PU (UNIT, SET, M)	PS*
			d	Article No.	Price per PU	

Complete units¹⁾ · Enclosure width 40 mm

 3SE5112-0BB01	Plain plungers					
	With high-grade steel plunger					
	Slow-action contacts	1 NO + 1 NC --	⊕ 2	3SE5112-0BB01		1 1 unit
	Snap-action contacts	1 NO + 1 NC --	⊕ 2	3SE5112-0CB01		1 1 unit
	Slow-action contacts	1 NO + 2 NC --	⊕ 5	3SE5112-0KB01		1 1 unit
	Snap-action contacts	1 NO + 2 NC --	⊕ 5	3SE5112-0LB01		1 1 unit
 3SE5112-0BC02	Rounded plungers, type B, acc. to EN 50041					
	With high-grade steel plungers, with 3 mm overtravel					
	Slow-action contacts	1 NO + 1 NC --	⊕ 5	3SE5112-0BC02		1 1 unit
	Snap-action contacts	1 NO + 1 NC --	⊕ ▶	3SE5112-0CC02		1 1 unit
	Snap-action contacts ²⁾	1 NO + 1 NC --	⊕ 5	3SE5112-0CC02-1AA7		1 1 unit
	Slow-action contacts	1 NO + 2 NC --	⊕ 5	3SE5112-0KC02		1 1 unit
	Snap-action contacts	1 NO + 2 NC --	⊕ 5	3SE5112-0LC02		1 1 unit
	Snap-action contacts with M12 device plug, 4-pole	1 NO + 1 NC --	⊕ 5	3SE5114-0CC02-1AC4		1 1 unit
 3SE5112-0BD02	Roller plungers, type C, acc. to EN 50041					
	With high-grade steel roller 13 mm, with 3 mm overtravel					
	Slow-action contacts	1 NO + 1 NC --	⊕ 5	3SE5112-0BD02		1 1 unit
	Snap-action contacts	1 NO + 1 NC --	⊕ ▶	3SE5112-0CD02		1 1 unit
	Snap-action contacts ²⁾	1 NO + 1 NC --	⊕ 5	3SE5112-0CD02-1AA7		1 1 unit
	Slow-action contacts	1 NO + 2 NC --	⊕ 5	3SE5112-0KD02		1 1 unit
	Snap-action contacts	1 NO + 2 NC --	⊕ 5	3SE5112-0LD02		1 1 unit
	Snap-action contacts ²⁾	1 NO + 2 NC --	⊕ 5	3SE5112-0LD02-1AA7		1 1 unit
	Slow-action contacts ²⁾	2 NO + 1 NC --	⊕ 5	3SE5112-0PD02-1AA7		1 1 unit
	With M12 device plug, 5-pole (125 V, 4 A)					
	Snap-action contacts with 2 LEDs	1 NO + 1 NC 24 V DC	⊕ 5	3SE5114-1CD02-1AF3		1 1 unit
	Snap-action contacts with 2 LEDs NEW	1 NO + 1 NC 24 V DC	⊕ 5	3SE5114-1CD02-1AF5		1 1 unit
	Snap-action contacts without LED	1 NO + 1 NC 24 V DC	⊕ 5	3SE5114-0CD02-1AC5		1 1 unit
	Snap-action contacts without LED ²⁾³⁾	1 NO + 1 NC 24 V DC	⊕ 5	3SE5114-0CD02-1AL0		1 1 unit
	With M12 device plug, 5-pole (125 V, 4 A), with pin assignment as for SIMATIC ET 200³⁾					
	Snap-action contacts without LED NEW	1 NO + 2 NC 24 V DC	⊕ X	3SE5114-0LD02-1AE3		1 1 unit
 3SE5112-0BE01	Roller levers					
	With metal lever and plastic roller 22 mm					
	Slow-action contacts	1 NO + 1 NC --	⊕ 5	3SE5112-0BE01		1 1 unit
	Snap-action contacts	1 NO + 1 NC --	⊕ ▶	3SE5112-0CE01		1 1 unit
	Slow-action contacts	1 NO + 2 NC --	⊕ 5	3SE5112-0KE01		1 1 unit
	Snap-action contacts	1 NO + 2 NC --	⊕ 5	3SE5112-0LE01		1 1 unit
 3SE5112-0BF01	Angular roller lever					
	With metal lever and plastic roller 22 mm					
	Slow-action contacts	1 NO + 1 NC --	⊕ 5	3SE5112-0BF01		1 1 unit
	Snap-action contacts	1 NO + 1 NC --	⊕ 2	3SE5112-0CF01		1 1 unit
	Snap-action contacts	1 NO + 2 NC --	⊕ 5	3SE5112-0LF01		1 1 unit
 3SE5112-0CR01	Spring rod					
	Length 142.5 mm, with plastic plunger 50 mm					
	Snap-action contacts	1 NO + 1 NC --	▶	3SE5112-0CR01		1 1 unit

⊕ Positive opening according to IEC 60947-5-1, Appendix K.

¹⁾ Popular versions.

²⁾ Increased operation or restoring force 30 N; only available as complete unit, no modular design

³⁾ The 3SE5114-.....-1AE3 position switches, prewired with an M12 plug, 5-pole, have the same pin assignment as all compact block I/O modules with a PROFINET connection in the SIMATIC ET 200eco PN, ET 200eco PN-F and ET 200AL series with IP65/IP67 degree of protection for cabinet-free installation directly at the machine.

SIRIUS 3SE5 Mechanical Position Switches

3SE5, Metal Enclosures

Enclosure width 40 mm according to EN 50041

2 or 3 contacts · Degree of protection IP66/IP67 · Cable entry M20 × 1.5

Version	Contacts	LEDs	SD	Complete units	Price per PU	PU (UNIT, SET, M)	PS*
			d	Article No.			

Complete units¹⁾ · Enclosure width 40 mm



3SE5112-0BH01

Twist levers, type A, acc. to EN 50041

With metal lever 27 mm and plastic roller 19 mm

Slow-action contacts	1 NO + 1 NC --		⊕ 5	3SE5112-0BH01		1	1 unit
Snap-action contacts	1 NO + 1 NC --		⊕ ▶	3SE5112-0CH01		1	1 unit
Slow-action contacts	1 NO + 2 NC --		⊕ 5	3SE5112-0KH01		1	1 unit
Snap-action contacts	1 NO + 2 NC --		⊕ 5	3SE5112-0LH01		1	1 unit

With M12 device plug, 5-pole (125 V, 4 A)

Snap-action contacts	1 NO + 1 NC --		⊕ 2	3SE5114-0CH01-1AC5		1	1 unit
----------------------	----------------	--	-----	--------------------	--	---	--------

With M12 device plug, 5-pole (125 V, 4 A), with pin assignment as for SIMATIC ET 200³⁾ **NEW**

Snap-action contacts	1 NO + 2 NC --		⊕ X	3SE5114-0LH01-1AE3		1	1 unit
----------------------	----------------	--	-----	--------------------	--	---	--------

With M12 device plug, 5-pole (125 V, 4 A), and 2 LEDs

Snap-action contacts	1 NO + 1 NC 24 V DC		⊕ 5	3SE5114-1CH01-1AF3		1	1 unit
----------------------	---------------------	--	-----	--------------------	--	---	--------

With metal lever 27 mm and high-grade steel roller 19 mm

Slow-action contacts	1 NO + 1 NC --		⊕ 5	3SE5112-0BH02		1	1 unit
Snap-action contacts	1 NO + 1 NC --		⊕ 2	3SE5112-0CH02		1	1 unit

With M12 device plug, 5-pole (125 V, 4 A), and 2 LEDs

Snap-action contacts	1 NO + 1 NC --		⊕ 5	3SE5114-1CH02-1AF3		1	1 unit
----------------------	----------------	--	-----	--------------------	--	---	--------

With metal lever 30 mm and plastic roller 19 mm

Snap-action contacts	1 NO + 1 NC --		⊕ ▶	3SE5112-0CH24		1	1 unit
----------------------	----------------	--	-----	---------------	--	---	--------

Twist levers, adjustable length

Metal lever, grid hole and plastic roller 19 mm

Slow-action contacts	1 NO + 1 NC --		⊕ 5	3SE5112-0BH60		1	1 unit
Snap-action contacts	1 NO + 1 NC --		⊕ ▶	3SE5112-0CH60		1	1 unit
Snap-action contacts	1 NO + 2 NC --		⊕ 5	3SE5112-0LH60		1	1 unit

Metal lever, grid hole with high-grade steel roller **NEW**

Snap-action contacts	1 NO + 1 NC --		X	3SE5114-0CH61-1AC5		1	1 unit
----------------------	----------------	--	---	--------------------	--	---	--------

With metal lever and plastic roller 19 mm

Slow-action contacts	1 NO + 1 NC --		5	3SE5112-0BH50		1	1 unit
Snap-action contacts	1 NO + 1 NC --		▶	3SE5112-0CH50		1	1 unit
Snap-action contacts	1 NO + 2 NC --		5	3SE5112-0LH50		1	1 unit

With M12 device plug, 5-pole (125 V, 4 A), and 2 LEDs

Snap-action contacts	1 NO + 1 NC 24 V DC		5	3SE5114-1CH60-1AF3		1	1 unit
----------------------	---------------------	--	---	--------------------	--	---	--------

With M12 device plug, 8-pole (30 V, 2 A), and 2 LEDs

Snap-action contacts	1 NO + 2 NC 24 V DC		5	3SE5114-1LH50-1AD4		1	1 unit
----------------------	---------------------	--	---	--------------------	--	---	--------

With metal lever and high-grade steel roller 19 mm

Snap-action contacts	1 NO + 1 NC --		5	3SE5112-0CH51		1	1 unit
----------------------	----------------	--	---	---------------	--	---	--------

Fork levers, latching

With metal lever and 2 plastic rollers 19 mm

Snap-action contacts	1 NO + 1 NC --		⊕ 5	3SE5112-0CT11		1	1 unit
----------------------	----------------	--	-----	---------------	--	---	--------

Rod actuators, type D, acc. to EN 50041

With aluminum rod, length 200 mm

Snap-action contacts	1 NO + 1 NC --		▶	3SE5112-0CH80		1	1 unit
----------------------	----------------	--	---	---------------	--	---	--------

With plastic rod, length 200 mm

Snap-action contacts	1 NO + 1 NC --		5	3SE5112-0CH82		1	1 unit
----------------------	----------------	--	---	---------------	--	---	--------

Nagara switch²⁾ With M12 device plug, 5-pole (125 V, 4 A) **NEW**

Snap-action contacts, short-stroke	1 NO + 1 NC --		5	3SE5114-0NH82-1AM2		1	1 unit
------------------------------------	----------------	--	---	--------------------	--	---	--------

⊕ Positive opening according to IEC 60947-5-1, Appendix X.

¹⁾ Popular versions.

²⁾ Start switch triggerable via one-hand operation (during operation)

³⁾ The 3SE5114-...-1AE3 position switches, prewired with an M12 plug, 5-pole, have the same pin assignment as all compact block I/O modules with a PROFINET connection in the SIMATIC ET 200eco PN, ET 200eco PN-F and ET 200AL series with IP65/IP67 degree of protection for cabinet-free installation directly at the machine.

Note:

If the device you require is not available as a complete unit, see Modular system, page 13/34.

SIRIUS 3SE5 Mechanical Position Switches

3SE5, Metal Enclosures

Enclosure width 40 mm according to EN 50041

Modular system

2 or 3 contacts · Degree of protection IP66/IP67 · Cable entry M20 × 1.5

Version	Contacts	LEDs	SD	Modular system	PU (UNIT, SET, M)	PS*
			d	Article No.	Price per PU	

Basic switches · Enclosure width 40 mm						
Connecting thread M20 × 1.5						
	Slow-action contacts	1 NO + 1 NC --	⊕ 5	3SE5112-0BA00	1	1 unit
	Snap-action contacts	1 NO + 1 NC --	⊕ 2	3SE5112-0CA00	1	1 unit
	• Gold-plated contacts		⊕ 5	3SE5112-0CA00-1AC1	1	1 unit
	Slow-action contacts	1 NO + 2 NC --	⊕ 2	3SE5112-0KA00	1	1 unit
	Snap-action contacts	1 NO + 2 NC --	⊕ 2	3SE5112-0LA00	1	1 unit
	Slow-action contacts with make-before-break	1 NO + 2 NC --	⊕ 2	3SE5112-0MA00	1	1 unit
	Slow-action contacts	2 NO + 1 NC --	⊕ 2	3SE5112-0PA00	1	1 unit
	Increased corrosion protection¹⁾					
	Slow-action contacts	1 NO + 1 NC --	⊕ 5	3SE5112-0BA00-1CA0	1	1 unit
	Snap-action contacts	1 NO + 1 NC --	⊕ 5	3SE5112-0CA00-1CA0	1	1 unit
	Slow-action contacts	1 NO + 2 NC --	⊕ 5	3SE5112-0KA00-1CA0	1	1 unit
	Snap-action contacts	1 NO + 2 NC --	⊕ 5	3SE5112-0LA00-1CA0	1	1 unit
	Slow-action contacts with make-before-break	1 NO + 2 NC --	⊕ 5	3SE5112-0MA00-1CA0	1	1 unit
	Slow-action contacts	2 NO + 1 NC --	⊕ 5	3SE5112-0PA00-1CA0	1	1 unit
M12 device plug, 5-pole (125 V, 4 A)						
	Slow-action contacts	1 NO + 1 NC --	⊕ 5	3SE5114-0BA00-1AC5	1	1 unit
	Snap-action contacts	1 NO + 1 NC --	⊕ 5	3SE5114-0CA00-1AC5	1	1 unit
	Slow-action contacts	2 NC --	⊕ 5	3SE5114-0KA00-1AE1	1	1 unit
	Snap-action contacts	2 NC --	⊕ 5	3SE5114-0LA00-1AE1	1	1 unit
With M12 device plug, 5-pole (125 V, 4 A), with pin assignment as for SIMATIC ET 200²⁾ <i>NEW</i>						
	Snap-action contacts	1 NO + 2 NC --	⊕ X	3SE5114-0LA00-1AE3	1	1 unit
Device plug, 6-pole + PE (250 V, 10 A)						
	Slow-action contacts	1 NO + 2 NC --	⊕ 5	3SE5115-0KA00-1AD1	1	1 unit
	Snap-action contacts	1 NO + 2 NC --	⊕ 5	3SE5115-0LA00-1AD1	1	1 unit
Device plug, 6-pole + PE (250 V, 10 A), and quick-release device						
	Snap-action contacts	1 NO + 1 NC --	⊕ 5	3SE5115-0CA00-1AD0	1	1 unit
2 LEDs, yellow/green						
	Slow-action contacts	1 NO + 2 NC 24 V DC	⊕ 5	3SE5112-1KA00	1	1 unit
	Snap-action contacts	1 NO + 2 NC 24 V DC	⊕ 5	3SE5112-1LA00	1	1 unit
	Slow-action contacts	1 NO + 2 NC 230 V AC	⊕ 5	3SE5112-3KA00	1	1 unit
	Snap-action contacts	1 NO + 2 NC 230 V AC	⊕ 5	3SE5112-3LA00	1	1 unit
M12 device plug, 5-pole (125 V, 4 A), and 2 LEDs						
	Slow-action contacts	1 NO + 1 NC 24 V DC	⊕ 5	3SE5114-1BA00-1AF3	1	1 unit
	Snap-action contacts	1 NO + 1 NC 24 V DC	⊕ 5	3SE5114-1CA00-1AF3	1	1 unit
M12 device plug, 8-pole (30 V, 2 A), and 2 LEDs						
	Snap-action contacts	1 NO + 2 NC 24 V DC	⊕ 5	3SE5114-1LA00-1AD4	1	1 unit
Device plug, 6-pole + PE (10 A), and 2 LEDs						
	Slow-action contacts	1 NO + 1 NC 24 V DC	⊕ 5	3SE5115-1BA00-1AF2	1	1 unit
	Snap-action contacts	1 NO + 1 NC 24 V DC	⊕ 5	3SE5115-1CA00-1AF2	1	1 unit
	Snap-action contacts	2 NC 24 V DC	⊕ 5	3SE5115-1LA00-1AD2	1	1 unit

¹⁾ Use corresponding high-grade steel lever.

²⁾ The 3SE5114-.....-1AE3 position switches, prewired with an M12 plug, 5-pole, have the same pin assignment as all compact block I/O modules with a PROFINET connection in the SIMATIC ET 200eco PN, ET 200eco PN-F and ET 200AL series with IP65/IP67 degree of protection for cabinet-free installation directly at the machine.







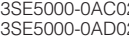

⊕ Positive opening according to IEC 60947-5-1, Appendix K, or positively driven actuator, necessary in safety circuits.

Note:
For the selection aid, see page 13/13

SIRIUS 3SE5 Mechanical Position Switches

3SE5, Metal Enclosures

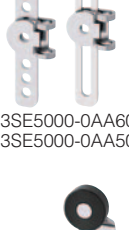
Enclosure width 40 mm according to EN 50041

Version	Diameter	SD	Modular system	PU (UNIT, SET, M)	PS*
	mm	d	Article No. Price per PU		
Operating mechanisms					
	Plain plungers				
	High-grade steel plunger	10	⊕ 2	3SE5000-0AB01	1 1 unit
	Rounded plungers, type B, acc. to EN 50041				
	High-grade steel plungers, with 3 mm overtravel	10	⊕ 5	3SE5000-0AC02	1 1 unit
	Roller plungers, type C, acc. to EN 50041				
	High-grade steel roller, with 3 mm overtravel	13	⊕ 5	3SE5000-0AD02	1 1 unit
	Roller levers				
	Metal lever, plastic roller	22	⊕ 2	3SE5000-0AE01	1 1 unit
	Metal lever, high-grade steel roller	22	⊕ 5	3SE5000-0AE02	1 1 unit
	High-grade steel lever, plastic roller	22	⊕ 5	3SE5000-0AE03	1 1 unit
	High-grade steel lever, high-grade steel roller	22	⊕ 5	3SE5000-0AE04	1 1 unit
	Angular roller levers				
	Metal lever, plastic roller	22	⊕ 2	3SE5000-0AF01	1 1 unit
	Metal lever, high-grade steel roller	22	⊕ 5	3SE5000-0AF02	1 1 unit
	High-grade steel lever, plastic roller	22	⊕ 5	3SE5000-0AF03	1 1 unit
	High-grade steel lever, high-grade steel roller	22	⊕ 5	3SE5000-0AF04	1 1 unit
	Spring rods (for switches with snap-action contacts only)				
	Plunger made of plastic, spring of high-grade steel:	7			
	• Length 142.5 mm (spring 50 mm, plunger 50 mm)		5	3SE5000-0AR01	1 1 unit
	• Length 76 mm (spring 23.5 mm, plunger 10 mm)		5	3SE5000-0AR03	1 1 unit
	• Length 242.5 mm (spring 150 mm, plunger 50 mm)		5	3SE5000-0AR04	1 1 unit
Plunger and spring made of high-grade steel:	7				
• Length 142.5 mm (spring 50 mm, plunger 50 mm)		5	3SE5000-0AR02	1 1 unit	
Twist actuators					
	Twist actuators, for 40/56/56 XL mm EN 50041				
	• For twist levers and rod actuators, switching right and/or left, adjustable		⊕ 2	3SE5000-0AH00	1 1 unit
	• For fork levers, latching		⊕ 5	3SE5000-0AT10	1 1 unit
	Levers				
	Twist levers, offset, type A, acc. to EN 50041				
	Metal lever 27 mm, plastic roller	19	⊕ 2	3SE5000-0AA01	1 1 unit
	Metal lever 27 mm, high-grade steel roller	19	⊕ 2	3SE5000-0AA02	1 1 unit
	Metal lever 27 mm, high-grade steel roller with ball bearing	19	⊕ 5	3SE5000-0AA03	1 1 unit
	Metal lever 27 mm, 2 plastic rollers	19	⊕ 5	3SE5000-0AA04	1 1 unit
	Metal lever 27 mm, plastic roller	30	⊕ 5	3SE5000-0AA05	1 1 unit
	Metal lever 27 mm, rubber roller	50	⊕ 5	3SE5000-0AA08	1 1 unit
	High-grade steel lever 27 mm, plastic roller	19	⊕ 5	3SE5000-0AA11	1 1 unit
	High-grade steel lever 27 mm, high-grade steel roller	19	⊕ 5	3SE5000-0AA12	1 1 unit
	Metal lever 35 mm, plastic roller	19	⊕ 5	3SE5000-0AA15	1 1 unit
	High-grade steel lever 35 mm, plastic roller	19	⊕ 5	3SE5000-0AA16	1 1 unit
	Twist levers 30 mm, straight				
	Metal lever, plastic roller	19	⊕ 5	3SE5000-0AA24	1 1 unit
	Metal lever, plastic roller	30	⊕ 5	3SE5000-0AA26	1 1 unit
	Twist levers, adjustable length, with grid hole				
Metal lever, plastic roller	19	⊕ 5	3SE5000-0AA60	1 1 unit	
Metal lever, high-grade steel roller	19	⊕ 5	3SE5000-0AA61	1 1 unit	
Metal lever, rubber roller	50	⊕ 5	3SE5000-0AA68	1 1 unit	
High-grade steel lever, plastic roller	19	⊕ 5	3SE5000-0AA62	1 1 unit	
High-grade steel lever, high-grade steel roller	19	⊕ 5	3SE5000-0AA63	1 1 unit	
	Twist levers, adjustable length				
	Metal lever, plastic roller	19	2	3SE5000-0AA50	1 1 unit
	Metal lever, high-grade steel roller	19	5	3SE5000-0AA51	1 1 unit
	Metal lever, plastic roller	30	5	3SE5000-0AA55	1 1 unit
	Metal lever, rubber roller	50	5	3SE5000-0AA58	1 1 unit
	High-grade steel lever, plastic roller	19	5	3SE5000-0AA52	1 1 unit
	High-grade steel lever, high-grade steel roller	19	5	3SE5000-0AA53	1 1 unit
	Fork levers (for switches with snap-action contacts only)				
	2 metal levers, 2 plastic rollers	19	⊕ 5	3SE5000-0AT01	1 1 unit
	2 metal levers, 2 high-grade steel rollers	19	⊕ 5	3SE5000-0AT02	1 1 unit
2 high-grade steel levers, 2 plastic rollers	19	⊕ 5	3SE5000-0AT03	1 1 unit	
	Rod actuators, type D, acc. to EN 50041				
	Aluminum rod, length 200 mm	6	5	3SE5000-0AA80	1 1 unit
	Spring rod, length 200 mm	6	5	3SE5000-0AA81	1 1 unit
	Plastic rod, length 200 mm	6	5	3SE5000-0AA82	1 1 unit

⊕ Positively driven actuator, necessary in safety circuits.

SIRIUS 3SE5 Mechanical Position Switches

3SE5, Metal Enclosures

Enclosure width 56 mm

Selection and ordering data

Complete units

2 or 3 contacts · Degree of protection IP66/IP67 · Cable entry 3 × (M20 × 1.5)

Version	Contacts	LEDs	SD	Complete units	PU (UNIT, SET, M)	PS*
			d	Article No.	Price per PU	

Complete units¹⁾ · Enclosure width 56 mm

Plain plungers

With high-grade steel plunger



3SE5122-0BB01

Slow-action contacts	1 NO + 1 NC --	⊕	5	3SE5122-0BB01		1 1 unit
Snap-action contacts	1 NO + 1 NC --	⊕	5	3SE5122-0CB01		1 1 unit
Slow-action contacts	1 NO + 2 NC --	⊕	5	3SE5122-0KB01		1 1 unit
Snap-action contacts	1 NO + 2 NC --	⊕	5	3SE5122-0LB01		1 1 unit
Slow-action contacts	2 NO + 1 NC --	⊕	5	3SE5122-0PB01		1 1 unit

Rounded plungers

With high-grade steel plungers, with 3 mm overtravel



3SE5122-0BC02

Slow-action contacts	1 NO + 1 NC --	⊕	5	3SE5122-0BC02		1 1 unit
Snap-action contacts	1 NO + 1 NC --	⊕	▶	3SE5122-0CC02		1 1 unit
Snap-action contacts ²⁾	1 NO + 1 NC --	⊕	5	3SE5122-0CC02-1AA7		1 1 unit
Slow-action contacts	1 NO + 2 NC --	⊕	5	3SE5122-0KC02		1 1 unit
Snap-action contacts	1 NO + 2 NC --	⊕	5	3SE5122-0LC02		1 1 unit
Slow-action contacts	2 NO + 1 NC --	⊕	5	3SE5122-0PC02		1 1 unit

Roller plunger

With high-grade steel roller 13 mm, with 3 mm overtravel



3SE5122-0BD02

Slow-action contacts	1 NO + 1 NC --	⊕	5	3SE5122-0BD02		1 1 unit
Snap-action contacts	1 NO + 1 NC --	⊕	2	3SE5122-0CD02		1 1 unit
Snap-action contacts ²⁾	1 NO + 1 NC --	⊕	5	3SE5122-0CD02-1AA7		1 1 unit
Slow-action contacts	1 NO + 2 NC --	⊕	5	3SE5122-0KD02		1 1 unit
Snap-action contacts	1 NO + 2 NC --	⊕	5	3SE5122-0LD02		1 1 unit

Roller levers

With metal lever and plastic roller 22 mm



3SE5122-0BE01

Slow-action contacts	1 NO + 1 NC --	⊕	5	3SE5122-0BE01		1 1 unit
Snap-action contacts	1 NO + 1 NC --	⊕	2	3SE5122-0CE01		1 1 unit
Slow-action contacts	1 NO + 2 NC --	⊕	5	3SE5122-0KE01		1 1 unit
Snap-action contacts	1 NO + 2 NC --	⊕	5	3SE5122-0LE01		1 1 unit
Slow-action contacts	2 NO + 1 NC --	⊕	5	3SE5122-0PE01		1 1 unit

With metal lever and high-grade steel roller 22 mm

Snap-action contacts	1 NO + 1 NC --	⊕	5	3SE5122-0CE02		1 1 unit
----------------------	----------------	---	---	---------------	--	----------

Angular roller lever

With metal lever and plastic roller 22 mm



3SE5122-0BF01

Slow-action contacts	1 NO + 1 NC --	⊕	5	3SE5122-0BF01		1 1 unit
Snap-action contacts	1 NO + 1 NC --	⊕	5	3SE5122-0CF01		1 1 unit
Slow-action contacts	2 NO + 1 NC --	⊕	5	3SE5122-0PF01		1 1 unit

⊕ Positive opening according to IEC 60947-5-1, Appendix K.

¹⁾ Popular versions.

²⁾ Increased operation or restoring force 30 N; only available as complete unit, no modular design

SIRIUS 3SE5 Mechanical Position Switches

3SE5, Metal Enclosures

Enclosure width 56 mm

2 or 3 contacts · Degree of protection IP66/IP67 · Cable entry 3 × (M20 × 1.5)

Version	Contacts	LEDs	SD	Complete units	<input type="checkbox"/>	PU (UNIT, SET, M)	PS*
			d	Article No.	Price per PU		

Complete units¹⁾ · Enclosure width 56 mm



3SE5122-OCR01

Spring rod

Length 142.5 mm, with plastic plunger 50 mm

Snap-action contacts	1 NO + 1 NC	--	5	3SE5122-OCR01		1	1 unit
----------------------	-------------	----	---	----------------------	--	---	--------



3SE5122-OBH01

Twist levers

With metal lever 27 mm and plastic roller 19 mm

Slow-action contacts	1 NO + 1 NC	--	⊕ 5	3SE5122-OBH01		1	1 unit
Snap-action contacts	1 NO + 1 NC	--	⊕ 2	3SE5122-0CH01		1	1 unit
Slow-action contacts	1 NO + 2 NC	--	⊕ 5	3SE5122-0KH01		1	1 unit
Snap-action contacts	1 NO + 2 NC	--	⊕ 5	3SE5122-0LH01		1	1 unit
Slow-action contacts	2 NO + 1 NC	--	⊕ 5	3SE5122-0PH01		1	1 unit

With metal lever 27 mm and high-grade steel roller 19 mm

Snap-action contacts	1 NO + 1 NC	--	⊕ 5	3SE5122-0CH02		1	1 unit
Snap-action contacts	1 NO + 2 NC	--	⊕ 5	3SE5122-0LH02		1	1 unit



3SE5122-0BH60

Twist levers, adjustable length

With metal lever with grid hole and plastic roller 19 mm

Slow-action contacts	1 NO + 1 NC	--	⊕ 5	3SE5122-0BH60		1	1 unit
Snap-action contacts	1 NO + 1 NC	--	⊕ 5	3SE5122-0CH60		1	1 unit
Snap-action contacts	1 NO + 2 NC	--	⊕ 5	3SE5122-0LH60		1	1 unit

With metal lever and plastic roller 19 mm

Slow-action contacts	1 NO + 1 NC	--	5	3SE5122-0BH50		1	1 unit
Snap-action contacts	1 NO + 1 NC	--	2	3SE5122-0CH50		1	1 unit
Snap-action contacts	1 NO + 2 NC	--	5	3SE5122-0LH50		1	1 unit



3SE5122-0CT11

Fork levers, latching

With metal lever and 2 plastic rollers 19 mm

Snap-action contacts	1 NO + 1 NC	--	⊕ 5	3SE5122-0CT11		1	1 unit
----------------------	-------------	----	-----	----------------------	--	---	--------



3SE5122-0CH80

Rod actuator

With aluminum rod, length 200 mm

Snap-action contacts	1 NO + 1 NC	--	5	3SE5122-0CH80		1	1 unit
----------------------	-------------	----	---	----------------------	--	---	--------

With plastic rod, length 200 mm

Snap-action contacts	1 NO + 1 NC	--	5	3SE5122-0CH82		1	1 unit
----------------------	-------------	----	---	----------------------	--	---	--------

⊕ Positive opening according to IEC 60947-5-1, Appendix K.

¹⁾ Popular versions.

Note:

If the device you require is not available as a complete unit, see [Modular system, page 13/38](#).

SIRIUS 3SE5 Mechanical Position Switches

3SE5, Metal Enclosures

Enclosure width 56 mm

Modular system

2 or 3 contacts · Degree of protection IP66/IP67 · Cable entry 3 × (M20 × 1.5)

Version	Contacts	LEDs	SD	Modular system	PU (UNIT, SET, M)	PS*
			d	Article No.	Price per PU	

Basic switches • Enclosure width 56 mm

With 3 × connection thread M20 × 1.5



3SE5122-0BA00

Slow-action contacts	1 NO + 1 NC	--	⊕ 2	3SE5122-0BA00	1	1 unit
Snap-action contacts	1 NO + 1 NC	--	⊕ 2	3SE5122-0CA00	1	1 unit
Slow-action contacts	1 NO + 2 NC	--	⊕ 5	3SE5122-0KA00	1	1 unit
Snap-action contacts	1 NO + 2 NC	--	⊕ 2	3SE5122-0LA00	1	1 unit
Slow-action contacts with make-before-break	1 NO + 2 NC	--	⊕ 2	3SE5122-0MA00	1	1 unit
Slow-action contacts	2 NO + 1 NC	--	⊕ 2	3SE5122-0PA00	1	1 unit

With increased corrosion protection¹⁾



3SE5122-0BA00-1CA0

Slow-action contacts	1 NO + 1 NC	--	⊕ 5	3SE5122-0BA00-1CA0	1	1 unit
Snap-action contacts	1 NO + 1 NC	--	⊕ 5	3SE5122-0CA00-1CA0	1	1 unit
Slow-action contacts	1 NO + 2 NC	--	⊕ 5	3SE5122-0KA00-1CA0	1	1 unit
Snap-action contacts	1 NO + 2 NC	--	⊕ 5	3SE5122-0LA00-1CA0	1	1 unit
Slow-action contacts with make-before-break	1 NO + 2 NC	--	⊕ 5	3SE5122-0MA00-1CA0	1	1 unit
Slow-action contacts	2 NO + 1 NC	--	⊕ 5	3SE5122-0PA00-1CA0	1	1 unit

With 2 LEDs, yellow/green



3SE5122-1KA00

Slow-action contacts	1 NO + 2 NC	24 V DC	⊕ 5	3SE5122-1KA00	1	1 unit
Snap-action contacts	1 NO + 2 NC	24 V DC	⊕ 5	3SE5122-1LA00	1	1 unit
Slow-action contacts	1 NO + 2 NC	230 V AC	⊕ 5	3SE5122-3KA00	1	1 unit
Snap-action contacts	1 NO + 2 NC	230 V AC	⊕ 5	3SE5122-3LA00	1	1 unit

⊕ Positive opening according to IEC 60947-5-1, Appendix K, or positively driven actuator, necessary in safety circuits.

¹⁾ Use corresponding high-grade steel lever.

Note:

For the selection aid, see page 13/13

Version	Diameter	SD	Modular system	PU (UNIT, SET, M)	PS*
	mm	d	Article No.	Price per PU	

Operating mechanisms



3SE5000-0AC02
3SE5000-0AD02

Plain plungers					
High-grade steel plungers	10	⊕ 2	3SE5000-0AB01	1	1 unit
Rounded plungers, type B, acc. to EN 50041					
High-grade steel plungers, with 3 mm overtravel	10	⊕ 5	3SE5000-0AC02	1	1 unit
Roller plungers, type C, acc. to EN 50041					
High-grade steel roller, with 3 mm overtravel	13	⊕ 5	3SE5000-0AD02	1	1 unit



3SE5000-0AE01

Roller levers					
Metal lever, plastic roller	22	⊕ 2	3SE5000-0AE01	1	1 unit
Metal lever, high-grade steel roller	22	⊕ 5	3SE5000-0AE02	1	1 unit
High-grade steel lever, plastic roller	22	⊕ 5	3SE5000-0AE03	1	1 unit
High-grade steel lever, high-grade steel roller	22	⊕ 5	3SE5000-0AE04	1	1 unit



3SE5000-0AF01

Angular roller levers					
Metal lever, plastic roller	22	⊕ 2	3SE5000-0AF01	1	1 unit
Metal lever, high-grade steel roller	22	⊕ 5	3SE5000-0AF02	1	1 unit
High-grade steel lever, plastic roller	22	⊕ 5	3SE5000-0AF03	1	1 unit
High-grade steel lever, high-grade steel roller	22	⊕ 5	3SE5000-0AF04	1	1 unit



3SE5000-0AR01

Spring rods (for switches with snap-action contacts only)					
Plunger made of plastic, spring of high-grade steel:	7				
• Length 142.5 mm (spring 50 mm, plunger 50 mm)		5	3SE5000-0AR01	1	1 unit
• Length 76 mm (spring 23.5 mm, plunger 10 mm)		5	3SE5000-0AR03	1	1 unit
• Length 242.5 mm (spring 150 mm, plunger 50 mm)		5	3SE5000-0AR04	1	1 unit
Plunger and spring made of high-grade steel:	7				
• Length 142.5 mm (spring 50 mm, plunger 50 mm)		5	3SE5000-0AR02	1	1 unit

SIRIUS 3SE5 Mechanical Position Switches

3SE5, Metal Enclosures

Enclosure width 56 mm

Version	Diameter	SD	Modular system	PU (UNIT, SET, M)	PS*
	mm	d	Article No.	Price per PU	
Twist actuators					
	Twist actuators, for 40/56/56 XL mm EN 50041				
		⊕ 2	3SE5000-0AH00		1 1 unit
		⊕ 5	3SE5000-0AT10		1 1 unit
	<ul style="list-style-type: none"> • For twist levers and rod actuators, switching right and/or left, adjustable • For fork levers, latching 				
Levers					
Twist levers 27 mm, offset, type A, acc. to EN 50041					
	Metal lever, plastic roller	19	⊕ 2	3SE5000-0AA01	1 1 unit
	Metal lever, high-grade steel roller	19	⊕ 2	3SE5000-0AA02	1 1 unit
	Metal lever, high-grade steel roller with ball bearing	19	⊕ 5	3SE5000-0AA03	1 1 unit
	Metal lever, 2 plastic rollers	19	⊕ 5	3SE5000-0AA04	1 1 unit
	Metal lever, plastic roller	30	⊕ 5	3SE5000-0AA05	1 1 unit
	Metal lever, plastic roller	50	⊕ 5	3SE5000-0AA07	1 1 unit
	Metal lever, rubber roller	50	⊕ 5	3SE5000-0AA08	1 1 unit
	High-grade steel lever, plastic roller	19	⊕ 5	3SE5000-0AA11	1 1 unit
	High-grade steel lever, high-grade steel roller	19	⊕ 5	3SE5000-0AA12	1 1 unit
Twist levers 35 mm, offset					
	Metal lever, plastic roller	19	⊕ 5	3SE5000-0AA15	1 1 unit
	High-grade steel lever, plastic roller	19	⊕ 5	3SE5000-0AA16	1 1 unit
Twist levers 30 mm, straight (can be mounted rotated by 180°)					
	Metal lever, plastic roller	19	⊕ 5	3SE5000-0AA24	1 1 unit
	Metal lever, plastic roller	30	⊕ 5	3SE5000-0AA26	1 1 unit
Twist levers, adjustable length, with grid hole					
	Metal lever, plastic roller	19	⊕ 5	3SE5000-0AA60	1 1 unit
	Metal lever, high-grade steel roller	19	⊕ 5	3SE5000-0AA61	1 1 unit
	Metal lever, plastic roller	50	⊕ 5	3SE5000-0AA67	1 1 unit
	Metal lever, rubber roller	50	⊕ 5	3SE5000-0AA68	1 1 unit
	High-grade steel lever, plastic roller	19	⊕ 5	3SE5000-0AA62	1 1 unit
	High-grade steel lever, high-grade steel roller	19	⊕ 5	3SE5000-0AA63	1 1 unit
Twist levers, adjustable length					
	Metal lever, plastic roller	19	2	3SE5000-0AA50	1 1 unit
	Metal lever, high-grade steel roller	19	5	3SE5000-0AA51	1 1 unit
	Metal lever, plastic roller	30	5	3SE5000-0AA55	1 1 unit
	Metal lever, plastic roller	50	5	3SE5000-0AA57	1 1 unit
	Metal lever, rubber roller	50	5	3SE5000-0AA58	1 1 unit
	High-grade steel lever, plastic roller	19	5	3SE5000-0AA52	1 1 unit
	High-grade steel lever, high-grade steel roller	19	5	3SE5000-0AA53	1 1 unit
Fork levers (for switches with snap-action contacts only)					
	2 metal levers, 2 plastic rollers	19	⊕ 5	3SE5000-0AT01	1 1 unit
	2 metal levers, 2 high-grade steel rollers	19	⊕ 5	3SE5000-0AT02	1 1 unit
	2 high-grade steel levers, 2 plastic rollers	19	⊕ 5	3SE5000-0AT03	1 1 unit
	2 high-grade steel levers, 2 high-grade steel rollers	19	⊕ 5	3SE5000-0AT04	1 1 unit
Rod actuators, type D, acc. to EN 50041					
	Aluminum rod, length 200 mm	6	5	3SE5000-0AA80	1 1 unit
	Spring rod, length 200 mm	6	5	3SE5000-0AA81	1 1 unit
	Plastic rod, length 200 mm	6	5	3SE5000-0AA82	1 1 unit

⊕ Positively driven actuator, necessary in safety circuits.

SIRIUS 3SE5 Mechanical Position Switches

3SE5, Metal Enclosures

Enclosure width 56 mm, XL

Selection and ordering data

Complete units

4 or 5 contacts · Degree of protection IP66/IP67 · Cable entry 3 × (M20 × 1.5)

Version	Contacts	LEDs	SD	Complete units	PU (UNIT, SET, M)	PS*
			d	Article No.	Price per PU	

Complete units¹⁾ · Enclosure width 56 mm, XL

	Plain plungers					
	With high-grade steel plunger					
3SE5162-0CB01	Snap-action contacts	2 × (1 NO + 1 NC) --	⊕ 5	3SE5162-0CB01		1 1 unit
	Rounded plungers					
	With high-grade steel plungers, with 3 mm overtravel					
	Slow-action contacts	1 NO + 1 NC --	⊕ 5	3SE5162-0EC02		1 1 unit
3SE5162-0EC02	Slow-action contacts with make-before-break 2 mm travel difference	1 NO + 2 NC				
	Roller plunger					
	With high-grade steel roller 13 mm, with 3 mm overtravel					
	Slow-action contacts	2 × (1 NO + 1 NC) --	⊕ 5	3SE5162-0BD02		1 1 unit
3SE5162-0BD02	Snap-action contacts	2 × (1 NO + 1 NC) --	⊕ 2	3SE5162-0CD02		1 1 unit
	Roller levers					
	With metal lever and plastic roller 22 mm					
	Slow-action contacts	2 × (1 NO + 1 NC) --	⊕ 5	3SE5162-0BE01		1 1 unit
	3SE5162-0BE01	Snap-action contacts	2 × (1 NO + 1 NC) --	⊕ 2	3SE5162-0CE01	
	With metal lever and high-grade steel roller 22 mm					
	Snap-action contacts	2 × (1 NO + 1 NC) --	⊕ 5	3SE5162-0CE02		1 1 unit
	Angular roller lever					
	With metal lever and plastic roller 22 mm					
3SE5162-0CF01	Snap-action contacts	2 × (1 NO + 1 NC) --	⊕ 5	3SE5162-0CF01		1 1 unit
	Twist levers					
	With metal lever 27 mm and plastic roller 19 mm					
3SE5162-0CH01	Snap-action contacts	2 × (1 NO + 1 NC) --	⊕ 2	3SE5162-0CH01		1 1 unit
	With high-grade steel lever 27 mm and high-grade steel roller 19 mm, increased corrosion protection					
	Snap-action contacts (gold contacts)	2 × (1 NO + 1 NC) --	⊕ 5	3SE5162-0CH12-1CC1		1 1 unit
	Twist levers, adjustable length					
	High-grade steel lever with grid hole and high-grade steel roller 19 mm, increased corrosion protection Adapter 3SX5100-3B included					
3SE5162-0CH01	Snap-action contacts (gold contacts)	2 × (1 NO + 1 NC) --	⊕ 5	3SE5162-0CH63-1AN4		1 1 unit

⊕ Positive opening according to IEC 60947-5-1, Appendix K.

¹⁾ Popular versions.

Note:

If the device you require is not available as a complete unit, see [Modular system](#), page 13/41.

SIRIUS 3SE5 Mechanical Position Switches

3SE5, Metal Enclosures

Enclosure width 56 mm, XL

Modular system

4 or 6 contacts · Degree of protection IP66/IP67 · Cable entry 3 × (M20 × 1.5)

Version	Contacts	LEDs	SD	Modular system		PU (UNIT, SET, M)	PS*
			d	Article No.	Price per PU		

Basic switches • Enclosure width 56 mm, XL



3SE5162-0BA00

With 3 × connection thread M20 × 1.5

Slow-action contacts	2 × (1 NO + 1 NC)	--		2	3SE5162-0BA00	1	1 unit
Snap-action contacts	2 × (1 NO + 1 NC)	--		2	3SE5162-0CA00	1	1 unit
Slow-action contacts with make-before-break	2 × (1 NO + 2 NC)	--		30	3SE5162-0DA00	1	1 unit

With increased corrosion protection¹⁾

Slow-action contacts	2 × (1 NO + 1 NC)	--		5	3SE5162-0BA00-1CA0	1	1 unit
Snap-action contacts	2 × (1 NO + 1 NC)	--		5	3SE5162-0CA00-1CA0	1	1 unit
Slow-action contacts with make-before-break	2 × (1 NO + 2 NC)	--		30	3SE5162-0DA00-1CA0	1	1 unit

Positive opening according to IEC 60947-5-1, Appendix K, or positively driven actuator, necessary in safety circuits.

¹⁾ Use corresponding high-grade steel lever.

Note:

For the selection aid, see page 13/13

Version	Diameter	SD	Modular system		PU (UNIT, SET, M)	PS*
	mm	d	Article No.	Price per PU		

Operating mechanisms



3SE5000-0AB01

Plain plungers

High-grade steel plunger	10		2	3SE5000-0AB01	1	1 unit
--------------------------	----	--	---	----------------------	---	--------



3SE5000-0AC02

Rounded plungers, type B, acc. to EN 50041

High-grade steel plungers, with 3 mm overtravel	10		5	3SE5000-0AC02	1	1 unit
---	----	--	---	----------------------	---	--------



3SE5000-0AD02

Roller plungers, type C, acc. to EN 50041

High-grade steel roller, with 3 mm overtravel	13		5	3SE5000-0AD02	1	1 unit
---	----	--	---	----------------------	---	--------



3SE5000-0AE01

Roller levers

Metal lever, plastic roller	22		2	3SE5000-0AE01	1	1 unit
Metal lever, high-grade steel roller	22		5	3SE5000-0AE02	1	1 unit
High-grade steel lever, plastic roller	22		5	3SE5000-0AE03	1	1 unit
High-grade steel lever, high-grade steel roller	22		5	3SE5000-0AE04	1	1 unit



3SE5000-0AF01

Angular roller levers

Metal lever, plastic roller	22		2	3SE5000-0AF01	1	1 unit
Metal lever, high-grade steel roller	22		5	3SE5000-0AF02	1	1 unit
High-grade steel lever, plastic roller	22		5	3SE5000-0AF03	1	1 unit
High-grade steel lever, high-grade steel roller	22		5	3SE5000-0AF04	1	1 unit



3SE5000-0AR01

Spring rods (for switches with snap-action contacts only)





Plunger made of plastic, spring of high-grade steel:	7					
• Length 142.5 mm (spring 50 mm, plunger 50 mm)			5	3SE5000-0AR01	1	1 unit
• Length 76 mm (spring 23.5 mm, plunger 10 mm)			5	3SE5000-0AR03	1	1 unit
• Length 242.5 mm (spring 150 mm, plunger 50 mm)			5	3SE5000-0AR04	1	1 unit
Plunger and spring made of high-grade steel:	7					
• Length 142.5 mm (spring 50 mm, plunger 50 mm)			5	3SE5000-0AR02	1	1 unit

Positively driven actuator, necessary in safety circuits.

SIRIUS 3SE5 Mechanical Position Switches

3SE5, Metal Enclosures

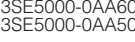
Enclosure width 56 mm, XL

Version	Diameter	SD	Modular system	PU (UNIT, SET, M)	PS*	
	mm	d	Article No.	Price per PU		
Twist actuators						
	Twist actuators, for 40/56/56 XL mm EN 50041					
	• For twist levers and rod actuators, switching right and/or left, adjustable	⊕ 2	3SE5000-0AH00	1	1 unit	
3SE5000-0AH00	• For fork levers, latching	⊕ 5	3SE5000-0AT10	1	1 unit	
Levers						
	Twist levers 27 mm, offset, type A, acc. to EN 50041					
	Metal lever, plastic roller	19	⊕ 2	3SE5000-0AA01	1 1 unit	
	Metal lever, high-grade steel roller	19	⊕ 2	3SE5000-0AA02	1 1 unit	
	Metal lever, high-grade steel roller with ball bearing	19	⊕ 5	3SE5000-0AA03	1 1 unit	
	Metal lever, 2 plastic rollers	19	⊕ 5	3SE5000-0AA04	1 1 unit	
	Metal lever, plastic roller	30	⊕ 5	3SE5000-0AA05	1 1 unit	
	Metal lever, plastic roller	50	⊕ 5	3SE5000-0AA07	1 1 unit	
	Metal lever, rubber roller	50	⊕ 5	3SE5000-0AA08	1 1 unit	
	High-grade steel lever, plastic roller	19	⊕ 5	3SE5000-0AA11	1 1 unit	
	High-grade steel lever, high-grade steel roller	19	⊕ 5	3SE5000-0AA12	1 1 unit	
Twist levers 35 mm, offset						
	Metal lever, plastic roller	19	⊕ 5	3SE5000-0AA15	1 1 unit	
	High-grade steel lever, plastic roller	19	⊕ 5	3SE5000-0AA16	1 1 unit	
Twist levers 30 mm, straight						
	Metal lever, plastic roller	19	⊕ 5	3SE5000-0AA24	1 1 unit	
	Metal lever, plastic roller	30	⊕ 5	3SE5000-0AA26	1 1 unit	
Twist levers, adjustable length, with grid hole						
	Metal lever, plastic roller	19	⊕ 5	3SE5000-0AA60	1 1 unit	
	Metal lever, high-grade steel roller	19	⊕ 5	3SE5000-0AA61	1 1 unit	
	Metal lever, plastic roller	50	⊕ 5	3SE5000-0AA67	1 1 unit	
	Metal lever, rubber roller	50	⊕ 5	3SE5000-0AA68	1 1 unit	
	High-grade steel lever, plastic roller	19	⊕ 5	3SE5000-0AA62	1 1 unit	
	High-grade steel lever, high-grade steel roller	19	⊕ 5	3SE5000-0AA63	1 1 unit	
Twist levers, adjustable length						
	Metal lever, plastic roller	19	2	3SE5000-0AA50	1 1 unit	
	Metal lever, high-grade steel roller	19	5	3SE5000-0AA51	1 1 unit	
	Metal lever, plastic roller	30	5	3SE5000-0AA55	1 1 unit	
	Metal lever, plastic roller	50	5	3SE5000-0AA57	1 1 unit	
	Metal lever, rubber roller	50	5	3SE5000-0AA58	1 1 unit	
	High-grade steel lever, plastic roller	19	5	3SE5000-0AA52	1 1 unit	
	High-grade steel lever, high-grade steel roller	19	5	3SE5000-0AA53	1 1 unit	
Fork levers (for switches with snap-action contacts only)						
	2 metal levers, 2 plastic rollers	19	⊕ 5	3SE5000-0AT01	1 1 unit	
	2 metal levers, 2 high-grade steel rollers	19	⊕ 5	3SE5000-0AT02	1 1 unit	
	2 high-grade steel levers, 2 plastic rollers	19	⊕ 5	3SE5000-0AT03	1 1 unit	
	2 high-grade steel levers, 2 high-grade steel rollers	19	⊕ 5	3SE5000-0AT04	1 1 unit	
3SE5000-0AT01						
Rod actuators, type D, acc. to EN 50041						
	Aluminum rod, length 200 mm	6	5	3SE5000-0AA80	1 1 unit	
	Spring rod, length 200 mm	6	5	3SE5000-0AA81	1 1 unit	
	Plastic rod, length 200 mm	6	5	3SE5000-0AA82	1 1 unit	
	Plastic rod, length 330 mm	6	5	3SE5000-0AA83	1 1 unit	
3SE5000-0AA80						

⊕ Positively driven actuator, necessary in safety circuits.

Overview

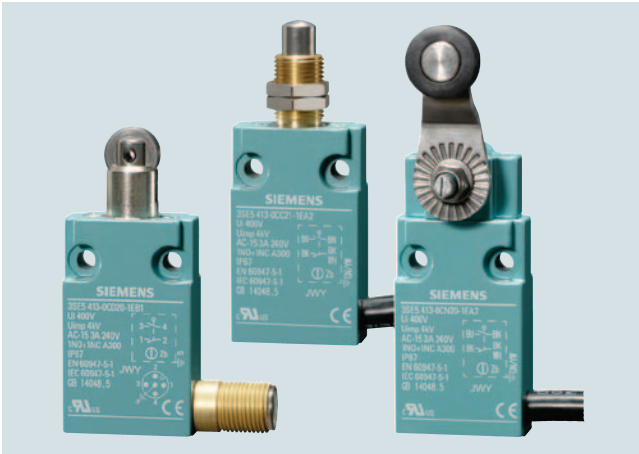

Compact design in width 30 mm

Particularly in harsh environments or on equipment with limited space, the small 3SE54 position switches in compact design with a depth of 16 mm and a weight of only 80 g (without cable) are ideal. Above all the versions with molded cable can be mounted in the most confined spaces.

3SE54 compact position switches are available in two different widths as complete units:

- The 3SE5413 series complies with the EU standard and features a 30-mm-wide enclosure with drilled holes at a distance of 20 mm.
- The 3SE5423 series meets the requirements of the US market and features a 40-mm-wide enclosure with drilled holes at a spacing of 25 mm.

Both the enclosure and the actuator head are made of metal and comply with the high IP67 degree of protection. The following actuators are available:

- Rounded plungers
- Rounded plungers with central fixing
- Rounded plungers with external seal
- Roller plungers
- Roller plungers with central fixing
- Twist levers

The contact block is designed with snap-action contacts 1 NO + 1 NC. The NC contact complies with the requirements for positive opening acc. to IEC 60947-5-1.

Use in safety circuits up to category 4 according to EN ISO 13849-1.

Connection:

- With molded cable, 2 m or 5 m long
- With M12 device plug

Benefits

- Very compact yet with the same rating as the 3SE51 standard switches, for notable space savings in confined installation conditions
- Various actuator versions available
- Roller plungers can be rotated through 90°
- Twist levers can be rotated through 180°; twist levers can be adjusted in 15° increments
- Time is saved when mounting the fully assembled unit
- With metal enclosure of degree of protection IP67, ideal for use in rough industrial environments
- Insensitive to electromagnetic interference

SIRIUS 3SE5 Mechanical Position Switches

3SE5, Metal Enclosures

Compact design



Selection and ordering data

2 snap-action contacts 1 NO + 1 NC · Degree of protection IP67 · With connecting cable or M12 device plug



Operating mechanism	Enclosure width	SD	Article No.	Price per PU	PU (UNIT, SET, M)	PS*
	mm	d				

Complete units • Enclosure width 30 or 40 mm

Rounded plungers

	• Standard mounting					
	- With 2 m cable 5 x 0.75 mm ²	30	⊕ 2	3SE5413-0CC20-1EA2		1 1 unit
		40	⊕ 2	3SE5423-0CC20-1EA2		1 1 unit
	- With 5 m cable 5 x 0.75 mm ²	30	⊕ 5	3SE5413-0CC20-1EA5		1 1 unit
	- With M12 device plug, 5-pole	30	⊕ 2	3SE5413-0CC20-1EB1		1 1 unit
	40	⊕ 5	3SE5423-0CC20-1EB1		1 1 unit	
	• With central fixing M12 x 1					
	- With 2 m cable 5 x 0.75 mm ²	30	⊕ 2	3SE5413-0CC21-1EA2		1 1 unit
	40	⊕ 5	3SE5423-0CC21-1EA2		1 1 unit	
	• With external seal					
	- With 2 m cable 5 x 0.75 mm ²	30	⊕ 5	3SE5413-0CC22-1EA2		1 1 unit
	40	⊕ 5	3SE5423-0CC22-1EA2		1 1 unit	

Roller plungers

	• Standard mounting					
	- With 2 m cable 5 x 0.75 mm ²	30	⊕ 2	3SE5413-0CD20-1EA2		1 1 unit
		40	⊕ 2	3SE5423-0CD20-1EA2		1 1 unit
	- With 5 m cable 5 x 0.75 mm ²	30	⊕ 5	3SE5413-0CD20-1EA5		1 1 unit
	- With M12 device plug, 5-pole	30	⊕ 2	3SE5413-0CD20-1EB1		1 1 unit
	40	⊕ 2	3SE5423-0CD20-1EB1		1 1 unit	
	• With central fixing M12 x 1					
	- With 2 m cable 5 x 0.75 mm ²	30	⊕ 2	3SE5413-0CD21-1EA2		1 1 unit
	40	⊕ 5	3SE5423-0CD21-1EA2		1 1 unit	
	• Actuator head rotated 90°					
	- With 2 m cable 5 x 0.75 mm ²	30	⊕ 2	3SE5413-0CD23-1EA2		1 1 unit

Twist levers

	• Standard mounting					
	- With 2 m cable 5 x 0.75 mm ²	30	⊕ 2	3SE5413-0CN20-1EA2		1 1 unit
		40	⊕ 5	3SE5423-0CN20-1EA2		1 1 unit
	- With 5 m cable 5 x 0.75 mm ²	30	⊕ 2	3SE5413-0CN20-1EA5		1 1 unit
	- With M12 device plug, 5-pole	30	⊕ 2	3SE5413-0CN20-1EB1		1 1 unit
	40	⊕ 5	3SE5423-0CN20-1EB1		1 1 unit	
	• Twist levers with a smaller mounting depth and lower height					
	- With 2 m cable 5 x 0.75 mm ²	30	⊕ 5	3SE5413-0CP20-1EA2		1 1 unit
	• Twist levers, adjustable length					
	- With 2 m cable 5 x 0.75 mm ²	30	⊕ X	3SE5413-0CQ20-1EA2		1 1 unit

⊕ Positive opening according to IEC 60947-5-1, Appendix K.

SIRIUS 3SE5 Mechanical Position Switches

3SE5, Open-Type Design

Enclosure width 30 mm

Overview

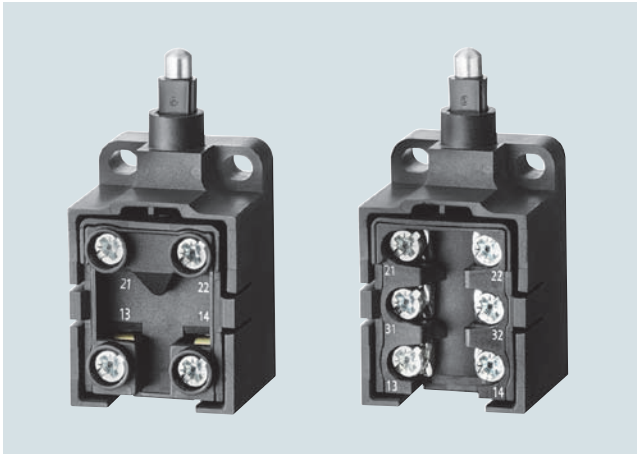

Open-type design

Their compact design makes these switches particularly suitable for use in confined conditions. The fixing dimensions and operating points are according to EN 50047.

The switches are equipped with two or three contacts in snap-action, slow-action or slow-action with make-before-break versions. The stroke is 6 mm.





The empty enclosure can be equipped with all contact block versions, (see page 13/47).

Improved version

The switches have a robust metal plunger with increased abrasion resistance (instead of the teflon plunger). This enables the switch to be approached from a 30° angle.

Selection and ordering data

2 or 3 contacts

Version	Contacts	SD	Article No.	Price per PU	PU (UNIT, SET, M)	PS*
Plastic enclosures • Enclosure width 30 mm						
With metal plunger						
	Slow-action contacts	1 NO + 1 NC	⊕ 2	3SE5250-0BC05	1	1 unit
	Snap-action contacts	1 NO + 1 NC	⊕ ▶	3SE5250-0CC05	1	1 unit
	Slow-action contacts	1 NO + 2 NC	⊕ 5	3SE5250-0KC05	1	1 unit
	Snap-action contacts	1 NO + 2 NC	⊕ ▶	3SE5250-0LC05	1	1 unit
	Slow-action contacts with make-before-break	1 NO + 2 NC	⊕ 2	3SE5250-0MC05	1	1 unit
	Slow-action contacts	2 NO + 1 NC	⊕ 2	3SE5250-0PC05	1	1 unit
	Empty enclosures without contact block	--	⊕ 5	3SE5250-0AC05	1	1 unit
Contact blocks with 2 contacts						
	For open-type design ¹⁾					
	• Slow-action contacts	1 NO + 1 NC	⊕ 5	3SE5050-0BA00	1	1 unit
	• Snap-action contacts	1 NO + 1 NC				
	- Standard		⊕ 5	3SE5050-0CA00	1	1 unit
- 2 × 2 mm switching interval		⊕ 30	3SE5050-0GA00	1	1 unit	
- Short stroke		⊕ 30	3SE5050-0NA00	1	1 unit	

⊕ Positive opening according to IEC 60947-5-1, Appendix K.



¹⁾ Contact blocks with 3 contacts, see page 13/47.

Selection and ordering data

The quick-release devices and plug-in connections are used for fast installation and replacement of position switches.

Version	SD	Article No.	Price per PU	PU (UNIT, SET, M)	PS*
---------	----	-------------	--------------	-------------------	-----





Quick-release devices for enclosure width 40 mm

	Adapter plates with screws	5	3SY3110		1 1 unit
	Base plate with locking lever	5	3SY3027		1 1 unit
					
3SY3110	3SY3027				

Plug-in connections for M20 x 1.5 connecting threads

	Device plugs (6-pole + PE), for M20 x 1.5 For max. 250 V, 10 A With connecting cable 0.75 mm ² , plastic, degree of protection IP65, ambient temperature -40 ... +90 °C	5	3SY3131		1 1 unit
	Cable box (6-pole + PE)¹⁾ With terminal compartment, can be pre-assembled, plastic, degree of protection IP65	2	3SY3136		1 1 unit
3SY3131	3SY3136				
	Device plugs (4-pole), M12, for M20 x 1.5, fixed For max. 250 V, 4 A, $U_{imp} = 2\,500\text{ V}$ With 4 connecting cables 0.25 mm ² , plastic, degree of protection IP67, ambient temperature -40 ... +85 °C	5	3SY3127		1 1 unit
	Device plugs (5-pole), M12, for M20 x 1.5, fixed For max. 125 V, 4 A, $U_{imp} = 1\,500\text{ V}$ With 5 connecting cables 0.25 mm ² , plastic, degree of protection IP67, ambient temperature -40 ... +85 °C	5	3SY3128		1 1 unit
3SY3127	3SY3128				
	Device plugs (8-pole), M12, for M20 x 1.5, fixed, plastic version²⁾ For max. 30 V, 1.5 A, $U_{imp} = 800\text{ V}$ With 8 connecting cables 0.25 mm ² , metal, degree of protection IP67, ambient temperature -25 ... +85 °C	NEW X	3SX5100-1SS51		1 1 unit
3SX5100-1SS51					
	M12 cable box, angled, 4-pole For AS-Interface, max. 4 A With cabling box, max. 0.75 mm ²	5	3RK1902-4CA00-4AA0		1 1 unit
3RK1902-4CA00-4AA0					

Adapters and cable glands for M20 x 1.5 connecting threads

	Adapters acc. to CE, RoHS and REACH For cable entry from M20 x 1.5 to NPT 1/2	5	3SX9917		1 1 unit
		30	3SX9918		1 1 unit
3SX9917	3SX9918				
	Cable glands M20 x 1.5 Plastic	2	3SX9926		1 1 unit
		5	3SX5601-1A		1 1 unit
3SX9926					







¹⁾ For wiring, a crimping tool is necessary, max. conductor cross-section 1 mm².

²⁾ Suitable for wiring sensors to be connected to all compact block I/O modules in the SIMATIC ET 200eco PN, ET 200eco PN-F and ET 200AL series.

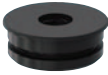
Position and Safety Switches

SIRIUS 3SE5 Mechanical Position Switches

Accessories and spare parts







Version	Color/ contacts	SD	Article No.	Price per PU	PU (UNIT, SET, M)	PS*
Optional accessories for 3SE51, 3SE52						
	Protective caps For rounded plungers acc. to EN 50047, 3SE5...-.C05	Black	2	3SE5000-0AC30	1	1 unit
3SE5000-0AC30						
	Adapters with screw¹⁾ For an increase in the mounting depth on the 3SE5000-0AH00 twist actuator, in combination with twist lever with adjust- able length or rod actuator		5	3SX5100-3B	1	1 unit
3SX5100-3B						
	Mounting plate Suitable for 3SE523. and 3SE521. position switches with a width of 31 mm (in particu- lar for control cabinet types)		5	3SX5100-1A	1	1 unit
3SX5100-1A						
Spare parts for 3SE51, 3SE52						
	Empty enclosures, plastic Enclosure width 31 mm • With increased corrosion protection	Turquoise	5	3SE5232-0AC05	1	1 unit
3SE5232-0AC05						
	Enclosure width 40 mm		5	3SE5232-0AC05-1CA0	1	1 unit
	Enclosure width 50 mm		5	3SE5132-0AA00	1	1 unit
	• With increased corrosion protection		5	3SE5242-0AC05	1	1 unit
			5	3SE5242-0AC05-1CA0	1	1 unit
	Empty enclosures, metal Enclosure width 31 mm • With increased corrosion protection	Turquoise	5	3SE5212-0AC05	1	1 unit
3SE5212-0AC05						
	Enclosure width 40 mm		5	3SE5212-0AC05-1CA0	1	1 unit
	• With increased corrosion protection		5	3SE5112-0AA00	1	1 unit
	Enclosure width 56 mm		5	3SE5112-0AA00-1CA0	1	1 unit
	• With increased corrosion protection		5	3SE5122-0AA00	1	1 unit
	Enclosure width 56 mm, XL ²⁾		5	3SE5122-0AA00-1CA0	1	1 unit
			5	3SE5162-0AA00	1	1 unit
	Contact blocks with 2 contacts³⁾ • Slow-action contacts • Snap-action contacts - Standard - Gold-plated contacts - 2 x 2 mm switching interval - Short stroke	1 NO + 1 NC 1 NO + 1 NC	⊕ 5 ⊕ 5 ⊕ 5 ⊕ 30 ⊕ 5	3SE5000-0BA00 3SE5000-0CA00 3SE5000-0CA00-1AC1 3SE5000-0GA00 3SE5000-0NA00	1 1 1 1 1	1 unit 1 unit 1 unit 1 unit 1 unit
3SE5000-0BA00						
	Contact blocks with 3 contacts • Slow-action contacts • Snap-action contacts • Slow-action contacts with make-before-break • Slow-action contacts	1 NO + 2 NC 1 NO + 2 NC 1 NO + 2 NC 2 NO + 1 NC	⊕ 5 ⊕ 5 ⊕ 2 ⊕ 2	3SE5000-0KA00 3SE5000-0LA00 3SE5000-0MA00 3SE5000-0PA00	1 1 1 1	1 unit 1 unit 1 unit 1 unit
3SE5000-0KA00						
	Contact blocks for XL enclosure²⁾ • Slow-action contacts • Snap-action contacts • Slow-action contacts with make-before-break	1 NO + 1 NC 1 NO + 1 NC 1 NO + 2 NC	⊕ 5 ⊕ 5 ⊕ 30	3SE5060-0BA00 3SE5060-0CA00 3SE5060-0MA00	1 1 1	1 unit 1 unit 1 unit
3SE5060-0BA00						

⊕ Positive opening according to IEC 60947-5-1, Appendix K.

¹⁾ Possibly required for the conversion from 3SE21 to 3SE51.

²⁾ Equip XL enclosures only with contact combinations, [see pages 13/12, 13/40 and 13/41](#)

³⁾ Unsuitable for open-type position switches, [see page 13/45](#).

Version	Rated voltage LED	SD	Article No.	Price per PU	PU (UNIT, SET, M)	PS*
	V	d				
Spare parts for 3SE51, 3SE52						
Covers for plastic enclosures, width 31 mm						
	• Turquoise with LED	24 DC	5	3SE5230-1AA00	1	1 unit
		230 AC	5	3SE5230-3AA00	1	1 unit
	• Yellow	--	5	3SE5230-0AA00-1AG0	1	1 unit
	• Yellow with LED	24 DC	5	3SE5230-1AA00-1AG0	1	1 unit
		230 AC	5	3SE5230-3AA00-1AG0	1	1 unit
3SE5230-1AA00						
Covers for plastic enclosures, width 40 mm						
	• Turquoise with LED	24 DC	5	3SE5130-1AA00	1	1 unit
		230 AC	5	3SE5130-3AA00	1	1 unit
	• Yellow	--	5	3SE5130-0AA00-1AG0	1	1 unit
	• Yellow with LED	24 DC	5	3SE5130-1AA00-1AG0	1	1 unit
		230 AC	5	3SE5130-3AA00-1AG0	1	1 unit
3SE5130-1AA00-1AG0						
Covers for plastic enclosures, width 50 mm						
	• Turquoise with LED	24 DC	5	3SE5240-1AA00	1	1 unit
		230 AC	5	3SE5240-3AA00	1	1 unit
	• Yellow	--	5	3SE5240-0AA00-1AG0	1	1 unit
	• Yellow with LED	24 DC	5	3SE5240-1AA00-1AG0	1	1 unit
		230 AC	5	3SE5240-3AA00-1AG0	1	1 unit
3SE5240-1AA00						
Covers for metal enclosures, width 31 mm						
	• Turquoise with LED	24 DC	5	3SE5210-1AA00	1	1 unit
		230 AC	5	3SE5210-3AA00	1	1 unit
	• Yellow	--	5	3SE5210-0AA00-1AG0	1	1 unit
	• Yellow with LED	24 DC	5	3SE5210-1AA00-1AG0	1	1 unit
		230 AC	5	3SE5210-3AA00-1AG0	1	1 unit
3SE5210-1AA00						
Covers for metal enclosures, width 40 mm						
	• Turquoise with LED	24 DC	5	3SE5110-1AA00	1	1 unit
		230 AC	5	3SE5110-3AA00	1	1 unit
	• Yellow	--	5	3SE5110-0AA00-1AG0	1	1 unit
	• Yellow with LED	24 DC	5	3SE5110-1AA00-1AG0	1	1 unit
		230 AC	5	3SE5110-3AA00-1AG0	1	1 unit
3SE5110-1AA00						
Covers for metal enclosures, width 56 mm						
	• Turquoise with LED	24 DC	5	3SE5120-1AA00	1	1 unit
		230 AC	5	3SE5120-3AA00	1	1 unit
	• Yellow	--	5	3SE5120-0AA00-1AG0	1	1 unit
	• Yellow with LED	24 DC	5	3SE5120-1AA00-1AG0	1	1 unit
		230 AC	5	3SE5120-3AA00-1AG0	1	1 unit
3SE5120-0AA00-1AG0						
Covers for XL metal enclosures, width 56 mm						
	• Yellow	--	5	3SE5160-0AA00-1AG0	1	1 unit

With Separate Actuator

With Separate Actuator

Overview

Safety switches with separate actuator are used where the position of doors, covers or protective grilles must be monitored for safety reasons.

3SE5 safety switches with separate actuator have the same enclosures as the 3SE5 position switches (modular system).



3SE5 safety switches with head for separate actuator

Design

Enclosure sizes

The 3SE5 safety switches are available in four different enclosure sizes:

- Plastic enclosures according to EN 50047, 31 mm wide, IP65, 1 cable entry
- Metal enclosures according to EN 50047, 31 mm wide, IP66/IP67, 1 cable entry
- Plastic and metal enclosures according to EN 50041, 40 mm wide, IP66/IP67, 1 cable entry
- Plastic enclosures, 50 mm wide, IP66/IP67, 2 cable entries
- Metal enclosures, 56 mm wide, IP66/IP67, 3 cable entries

Also available are safety switches in the 3SE2 series which have been developed in this form according to general market requirements:

- Molded-plastic enclosures outside of the standards, enclosure width 52 mm, IP67

Enclosure versions

Various basic versions can be selected for the enclosures of the 3SE5 series:

- Available with two- or three-pole contact blocks designed as slow-action contacts
- Optional LED status display
- With mounted four or five-pole M12 device plug (available for the wide enclosures as an accessory for self-assembly)
- With 6-pole device plug + PE on the metal enclosures
- Similarly with a combination of plug and LED indicators
- AS-Interface version with integrated ASIsafe electronics for all enclosure designs (see page 13/93).

For a description of the basic switches, (see page 13/7).

Operation

The actuator head is included in the scope of supply. For actuation from four directions it can be adjusted through $4 \times 90^\circ$. The switches can also be approached from above.

The actuator heads of the 3SE2243 and 3SE2257 switches with special enclosures cannot be changed. The switches can be approached from the two broad sides and from above.

The actuator is not included in the scope of supply of the safety switches and must be ordered separately from a choice of different versions to suit the application (see page 13/56).

The actuator is encoded. Simple overruling by hand or auxiliary devices is impossible.

Radius actuators

The safety switches with radius actuators are particularly suitable for rotary protective devices. The movable actuation key allows even small radii to be approached. Damage to the switch and the actuator due to inaccurate approach is prevented.

Locking devices

A high-grade steel blocking insert for attaching up to eight padlocks is available for even more security (see page 13/56).

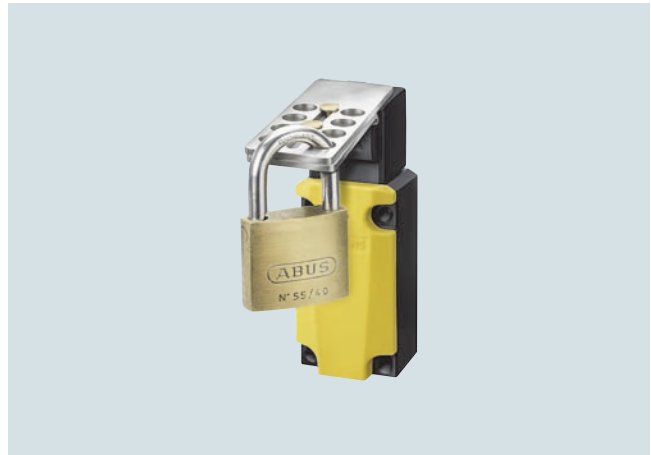

Blocking inserts with padlock

Dust protection

For use in dusty environments, a rubber cap is offered that protects the actuator entries of the actuator head from contamination (see page 13/56).

Contact reliability

The contact blocks ensure an extremely high contact stability. This applies even when the devices are switching low voltages and currents, e.g. 1 mA at 5 V DC.

Positive opening ⊕

The NC contacts of the switch are forced open mechanically, positively-driven and reliably by the plunger. This is referred to as "positive opening".

Benefits

The 3SE5 safety switches with separate actuator differ from the previous series through the following new properties:

- All enclosure sizes with increased corrosion protection are optionally available with an LED signaling indicator.
- The three-pole contact block 1 NO + 2 NC is available for all enclosure sizes.
- The plastic enclosure has simple and fast wiring equipment which makes it possible to save approx. 20 to 25% of the time when connecting.
- The ASI-safe electronics are integrated in the enclosure for the versions with AS-Interface connection (see page 13/93); an additional adapter is not required.

Application

Safety switches with separate actuator are used where the position of doors, covers or protective grilles must be monitored for safety reasons.

The safety switch can only be operated with the matching coded actuator. Simple overruling by hand or auxiliary devices is impossible.

Devices are available with enclosure versions to suit the particular ambient conditions. The high-grade steel actuator IP69K with optimized geometry is suitable for extreme environmental conditions as low as -40 °C. Different control tasks can be performed with the best contact blocks suited for the particular purpose. Dimensions and fixing points of the enclosure are in accordance with EN 50041 or EN 50047 standards. The devices are suitable for use in any climate.

Standards

IEC/EN 60947-5-1

The protective measure of "total insulation" by the molded-plastic enclosure is ensured by the use of molded-plastic screw glands.

Safety position switches

For controls according to IEC/EN 60204-1, the devices can be used as a safety position switch. They comply with the standard EN ISO 14119. A TÜV certificate is available. To secure position switches against changes in their position, keyed techniques must be employed on installation.

Safety circuits

The IEC/EN 60947-5-1 standard requires positive opening of the NC contacts. In other words, for the purposes of personal safety, the assured opening of NC contacts is expressly stipulated for the electrical equipment of machines in all safety circuits and marked in accordance with the standard IEC 60947-5-1 with the symbol \ominus .

Category 3 according to EN ISO 13849-1 can be attained with a safety switch with separate actuator if the corresponding fail-safe evaluation units are selected and correctly installed, e.g. the 3SK, 3TK28 safety relays or matching units from the ASI-safe, SIMATIC or SINUMERIK product ranges.

Category 4 can be achieved when using an additional 3SE5 safety switch.

Technical specifications

Type	3SE51...-V.., 3SE52...-V..	3SE2257-XX..	3SE2243-XX..
General data			
Standards	IEC 60947-5-1, EN 60947-5-1, EN ISO 14119		
Rated insulation voltage U_i	V 400	500	
Degree of pollution according to IEC 60664-1	Class 3	Class 3	
Rated impulse withstand voltage U_{imp}	kV 6		
Rated operational voltage U_e	V 400 AC; over 300 V AC same potential only	500 AC; over 380 V AC same potential only	
Conventional thermal current I_{th}	A 6	10	
Rated operational current I_e		1-pole	3-pole
• With alternating current 50/60 Hz	I_e / AC-15	I_e / AC-12	I_e / AC-15
- At 24 V	A 6	10	10
- At 120 V	A 6	10	10
- At 240 V	A 4	10	10
- At 400 V	A 4	10	10
- At 500 V	A --	10	10
• For direct current	I_e / DC-13	I_e / DC-12	I_e / DC-13
- At 24 V	A 3	10	10
- At 125 V	A 0.55	--	--
- At 250 V	A 0.27	--	--
- At 110 V	A --	4	4
- At 220 V	A --	1	1
- At 400 V	A 0.12	--	--
- At 440 V	A --	0.5	0.5
Short-circuit protection			
• With DIAZED fuse links, operational class gG	A 6	6	
• With fuse links, quick	A --	10	
• With miniature circuit breaker, C char. ($I_{K < 400A}$)	A 1	--	
Mechanical endurance	1 × 10 ⁶ operating cycles		
Electrical endurance			
• With 3RH.1, 3RT contactors in size S00, S0	1 × 10 ⁶ operating cycles	> 1 × 10 ⁶ operating cycles	
• For utilization category AC-15 when switching off I_e / AC-15 at 240 V	100 000 operating cycles	500 000 operating cycles	
Switching frequency	6 000 operating cycles/h		
With 3RH.1, 3RT contactors in size S00, S0			
Minimum pull-out force for positive opening	N 20	10	30

SIRIUS 3SE5, 3SE2 Mechanical Safety Switches

With Separate Actuator

3SE5, plastic enclosures, enclosure width 40 mm according to EN 50041

Selection and ordering data

2 or 3 contacts · 5 directions of approach · Degree of protection IP65 · Cable entry M20 × 1.5

Version ¹⁾	Contacts	LEDs	SD	Complete units	<input type="checkbox"/>	PU (UNIT, SET, M)	PS*
			d	Article No.	Price per PU		

Enclosure width 31 mm according to EN 50047



3SE5232-0RV40

Slow-action contacts	1 NO + 1 NC	--	↻ 5	3SE5232-0RV40		1	1 unit
Slow-action contacts	1 NO + 2 NC	--	↻ ▶ 5	3SE5232-0QV40		1	1 unit
With increased minimum pull-out force 30 N							
Slow-action contacts	1 NO + 2 NC	--	↻ 5	3SE5232-0QV40-1AA1		1	1 unit



3SE5234-0RV40-1AC4

With M12 device plug, 4-pole (250 V, 4 A)							
Slow-action contacts	1 NO + 1 NC	--	↻ 5	3SE5234-0RV40-1AC4		1	1 unit
Slow-action contacts	2 NC	--	↻ 5	3SE5234-0QV40-1AE0		1	1 unit

With M12 device plug, 5-pole (125 V, 4 A), with pin assignment as for SIMATIC ET 200²⁾ NEW

Slow-action contacts	2 NC	--	↻ X	3SE5234-0QV40-1AE2		1	1 unit
----------------------	------	----	-----	---------------------------	--	---	--------

With 2 LEDs, yellow/green

Slow-action contacts	1 NO + 1 NC	24 V DC	↻ 5	3SE5232-1RV40		1	1 unit
Slow-action contacts	1 NO + 1 NC	230 V AC	↻ 5	3SE5232-3RV40		1	1 unit

With M12 device plug, 5-pole (125 V, 4 A), and 2 LEDs

Slow-action contacts	1 NO + 1 NC	24 V DC	↻ 5	3SE5234-1RV40-1AF3		1	1 unit
----------------------	-------------	---------	-----	---------------------------	--	---	--------



3SE5232-1RV40

↻ Positive opening according to IEC 60947-5-1, Appendix K.

¹⁾ Supplied without actuator. Please order separately (see page 13/56).

²⁾ The 3SE5234-.....-1AE2 position switches, prewired with an M12 plug, 5-pole, have the same pin assignment as all compact block I/O modules with a PROFINET connection in the SIMATIC ET 200eco PN, ET 200eco PN-F and ET 200AL series with IP65/IP67 degree of protection for cabinet-free installation directly at the machine.



SIRIUS 3SE5, 3SE2 Mechanical Safety Switches

With Separate Actuator

3SE5, plastic enclosures, enclosure width 40 mm according to EN 50041

Selection and ordering data

2 or 3 contacts · 5 directions of approach · Degree of protection IP66/IP67 · Cable entry M20 × 1.5

Version ¹⁾	Contacts	LEDs	SD	Complete units	PU (UNIT, SET, M)	PS*
				Article No.	Price per PU	
Enclosure width 40 mm acc. to EN 50041						
	Slow-action contacts	1 NO + 2 NC --	↻ 5	3SE5132-0QV20		1 1 unit
3SE5132-0QV20						
With 2 LEDs, yellow/green						
	Slow-action contacts	1 NO + 2 NC	↻ 5	3SE5132-1QV20		1 1 unit
	Slow-action contacts	1 NO + 2 NC	↻ 5	3SE5132-3QV20		1 1 unit
3SE5132-1QV20						

↻ Positive opening according to IEC 60947-5-1, Appendix K.

¹⁾ Supplied without actuator. Please order separately (see page 13/56).



SIRIUS 3SE5, 3SE2 Mechanical Safety Switches

With Separate Actuator

3SE5, plastic enclosures, enclosure width 50 mm

Selection and ordering data

2 or 3 contacts · 5 directions of approach · Degree of protection IP66/IP67 · Cable entry M20 × 1.5

Version ¹⁾	Contacts	LEDs	SD	Complete units	PU (UNIT, SET, M)	PS*
				Article No.	Price per PU	
Enclosure width 50 mm						
 3SE5242-0QV40	Slow-action contacts	1 NO + 2 NC --	⊕ 5	3SE5242-0QV40		1 1 unit
	With increased minimum pull-out force 30 N					
	Slow-action contacts	1 NO + 1 NC --	⊕ 5	3SE5242-0RV40-1AA1		1 1 unit
With 2 LEDs, yellow/green						
 3SE5242-1QV40	Slow-action contacts	1 NO + 2 NC	⊕ 5	3SE5242-1QV40		1 1 unit
	Slow-action contacts	1 NO + 2 NC	24 V DC 230 V AC	⊕ 5	3SE5242-3QV40	

⊕ Positive opening according to IEC 60947-5-1, Appendix K.

¹⁾ Supplied without actuator. Please order separately (see page 13/56).



SIRIUS 3SE5, 3SE2 Mechanical Safety Switches

With Separate Actuator

3SE5, metal enclosures, enclosure width 31 mm according to EN 50047

Selection and ordering data

2 or 3 contacts · 5 directions of approach · Degree of protection IP66/IP67 · Cable entry M20 × 1.5

Version ¹⁾	Contacts	LEDs	SD	Complete units	PU (UNIT, SET, M)	PS*
				Article No.	Price per PU	
Enclosure width 31 mm according to EN 50047						
	Slow-action contacts	1 NO + 1 NC --	↻ 2	3SE5212-0RV40	1	1 unit
	Slow-action contacts	1 NO + 2 NC --	↻ 5	3SE5212-0QV40	1	1 unit
3SE5212-0RV40						
With 2 LEDs, yellow/green						
	Slow-action contacts	1 NO + 1 NC 24 V DC	↻ 5	3SE5212-1RV40	1	1 unit
	Slow-action contacts	1 NO + 1 NC 230 V AC	↻ 5	3SE5212-3RV40	1	1 unit
3SE5212-1RV40						

↻ Positive opening according to IEC 60947-5-1, Appendix K.

¹⁾ Supplied without actuator. Please order separately (see page 13/56).

SIRIUS 3SE5, 3SE2 Mechanical Safety Switches

With Separate Actuator

3SE5, metal enclosures, enclosure width 40 mm according to EN 50041 / 56 mm

Selection and ordering data

2 or 3 contacts · 5 directions of approach · Degree of protection IP66/IP67 · Cable entry M20 × 1.5

Version ¹⁾	Contacts	LEDs	SD	Complete units	PU (UNIT, SET, M)	PS*
			d	Article No.	Price per PU	
Enclosure width 40 mm acc. to EN 50041						
	Slow-action contacts	1 NO + 2 NC --	⊕ ▶	3SE5112-0QV10		1 1 unit
	With increased minimum pull-out force 30 N					
	Slow-action contacts	1 NO + 2 NC --	⊕ 5	3SE5112-0QV10-1AA7		1 1 unit
	With M12 device plug, 5-pole (125 V, 4 A)					
	Slow-action contacts	1 NO + 1 NC --	⊕ 5	3SE5114-0RV10-1AC5		1 1 unit
	Slow-action contacts	2 NC --	⊕ 5	3SE5114-0QV10-1AE1		1 1 unit
	With M12 device plug, 5-pole (125 V, 4 A), with pin assignment as for SIMATIC ET 200²⁾ <i>NEW</i>					
	Slow-action contacts	2 NC --	⊕ X	3SE5114-0QV10-1AE3		1 1 unit
	With device plug, 6-pole + PE (250 V, 10 A)					
	Slow-action contacts	1 NO + 2 NC --	⊕ 5	3SE5115-0QV10-1AD1		1 1 unit
	With 2 LEDs, yellow/green					
	Slow-action contacts	1 NO + 2 NC 24 V DC	⊕ 5	3SE5112-1QV10		1 1 unit
	Slow-action contacts	1 NO + 2 NC 230 V AC	⊕ 5	3SE5112-3QV10		1 1 unit
	With M12 device plug, 5-pole (125 V, 4 A), and 2 LEDs					
	Slow-action contacts	1 NO + 1 NC 24 V DC	⊕ 5	3SE5114-1RV10-1AF3		1 1 unit
	With device plug, 6-pole + PE (250 V, 10 A), and 2 LEDs					
	Slow-action contacts	1 NO + 1 NC 24 V DC	⊕ 5	3SE5115-1RV10-1AF2		1 1 unit
Enclosure width 56 mm						
	Slow-action contacts	1 NO + 2 NC --	⊕ 5	3SE5122-0QV10		1 1 unit
	With increased minimum pull-out force 30 N					
	Slow-action contacts	1 NO + 2 NC --	⊕ 5	3SE5122-0QV10-1AA7		1 1 unit
	With 2 LEDs, yellow/green					
	Slow-action contacts	1 NO + 2 NC 24 V DC	⊕ 5	3SE5122-1QV10		1 1 unit
	Slow-action contacts	1 NO + 2 NC 230 V AC	⊕ 5	3SE5122-3QV10		1 1 unit

⊕ Positive opening according to IEC 60947-5-1, Appendix K.

¹⁾ Supplied without actuator. Please order separately (see page 13/56).











²⁾ The 3SE5114-.....-1AE3 position switches, prewired with an M12 plug, 5-pole, have the same pin assignment as all compact block I/O modules with a PROFINET connection in the SIMATIC ET 200eco PN, ET 200eco PN-F and ET 200AL series with IP65/IP67 degree of protection for cabinet-free installation directly at the machine.

SIRIUS 3SE5, 3SE2 Mechanical Safety Switches

With Separate Actuator

Accessories

Selection and ordering data

Version	SD	Article No.	Price per PU	PU (UNIT, SET, M)	PS*
IP66/IP67					
 3SE5000-0AV01		Standard actuator • Length 75.6 mm		1	1 unit
 3SE5000-0AV02	5	• With vertical fixing, length 53 mm		1	1 unit
 3SE5000-0AV03	5	• With transverse fixing, length 47 mm		1	1 unit
 3SE5000-0AW11	5	• With transverse fixing, plastic ¹⁾ , length 40 mm		1	1 unit
 3SE5000-0AW51	5	High-grade steel actuator, IP69K²⁾ • Length 75.6 mm		1	1 unit
 3SE5000-0AV06	2 5	Radius actuator , length 51 mm • Direction of approach from the left • Direction of approach from the right		1 1	1 unit 1 unit
 3SE5000-0AV05-1AA6	5 5	Universal radius actuator • Length 77 mm • Length 77 mm, tab rotated 90°		1 1	1 unit 1 unit
 3SE5000-0AV07	2 5	Universal radius actuator, heavy duty • Length 67 mm • Length 77 mm		1 1	1 unit 1 unit
Optional accessories for 3SE5					
 3SE5000-0AV08-1AA2	5	Protective caps , black rubber For the actuator head, to protect the actuator openings from contamination (Only for enclosure width 40 or 56 mm)		1	1 unit
 3SE5000-0AV08-1AA3	5	Blocking inserts , high-grade steel, for actuator head For up to eight padlocks		1	1 unit
Connections for 3SE5, 3SE2					
 3SY3127 3SX9926	5 5	Device plugs (4-pole), M12, fixed for M20 x 1.5 With connecting cable 0.25 mm ² , plastic, degree of protection IP67, ambient temperature -40 to +85 °C For max. 250 V, 4 A For max. 125 V, 4 A		1 1	1 unit 1 unit
	2	Cable glands M20 x 1.5 Plastic		1	1 unit

¹⁾ Not suitable for safety switches with tumbler.

²⁾ With optimized geometry and suitable for extreme environmental conditions such as -40 °C







SIRIUS 3SE5, 3SE2 Mechanical Safety Switches

With Separate Actuator

3SE2, plastic enclosures, special width 52 mm

Selection and ordering data

1 or 3 contacts · 3 directions of approach · Degree of protection IP67

Version	Operation	SD	Complete units	PU (UNIT, SET, M)	PS*	
		d	Article No.	Price per PU		
Plastic enclosures in special width of 52 mm						
 <p>3SE2243</p>	Lateral and front-end actuation ¹⁾		6 mm stroke			
	<ul style="list-style-type: none"> With connecting thread M20 × 1.5 					
	- Slow-action contacts		Holding force 5 N	⊙ 2	3SE2243-0XX40	1 1 unit
	1 NO + 2 NC		Holding force 30 N	⊙ 2	3SE2243-0XX	1 1 unit
			With automatic ejection	⊙ 2	3SE2243-0XX30	1 1 unit
	- Slow-action contacts		Holding force 5 N	⊙ 15	3SE2257-6XX40	1 1 unit
	1 NC		Holding force 30 N	⊙ 15	3SE2257-6XX	1 1 unit
			With automatic ejection	⊙ 5	3SE2257-6XX30	1 1 unit
	<ul style="list-style-type: none"> With connecting thread M16 × 1.5 					
	- Slow-action contacts		Holding force 30 N	⊙ 10	3SE2243-0XX18	1 1 unit
1 NO + 2 NC						
Accessories						
Actuators						
 <p>3SX3218</p>	<ul style="list-style-type: none"> Standard actuators 		2	3SX3218	1 1 unit	
	(r _{min} = 150 mm), length 28 mm					
 <p>3SX3228</p>	<ul style="list-style-type: none"> Universal radius actuator 		2	3SX3228	1 1 unit	
	(r _{min} = 45 mm), length 34 mm					
 <p>3SX3256</p>	<ul style="list-style-type: none"> Radius actuator, adjustable radius, 		10	3SX3256	1 1 unit	
	length 34 mm					
 <p>3SX3217</p>	<ul style="list-style-type: none"> Ball locating, 		2	3SX3217	1 1 unit	
	force adjustable up to max. 100 N by 2 adjustable screws, length 28 mm					
 <p>3SX3234</p>	<ul style="list-style-type: none"> Actuator, length 34 mm, 		30	3SX3234	1 1 unit	
	with dust protection and slit cover					
Accessories						
	<ul style="list-style-type: none"> Slit cover 		30	3SX3233	1 3 units	
	(1 set = 3 units)					

⊙ Positive opening according to IEC 60947-5-1, Appendix K.

¹⁾ Supplied without actuator.

Overview

The safety switches with tumbler are exceptional safety-related devices which prevent an unforeseen or intentional opening of protective doors, protective grilles or other covers as long as a dangerous situation is present (i.e. follow-on motion of the switched-off machine).

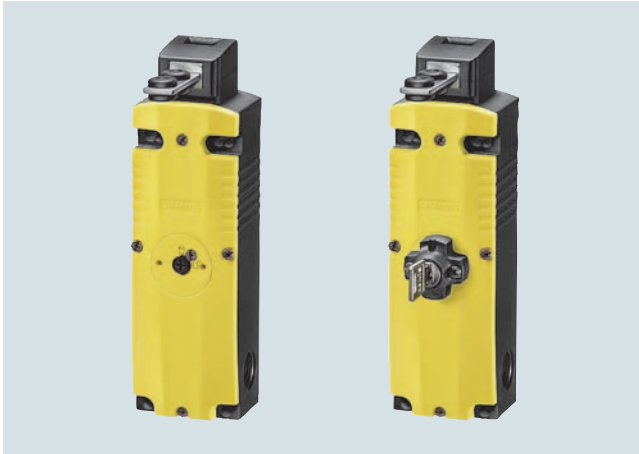

3SE5 safety switch with tumbler

The safety switches with tumbler are comprised of a switch part with electromechanical tumbler and a mechanical actuator which has to be ordered separately.

They are rugged protective devices that enable the greatest possible safety for man and machine.

The safety switches with tumbler are offered in plastic or metal enclosures.

Dimensions (W x H x D): 54 mm x 185 mm x 43.5 mm

Operation

The actuator head is included in the scope of supply. For actuation from four directions it can be adjusted through 4 x 90°. The switches can also be approached from above.

The actuator is not included in the scope of supply of the safety switches and must be ordered separately from a choice of different versions to suit the application (see page 13/64).

Actuation data:

- Maximum actuating speed $v_{max} = 1.5 \text{ m/s}$
- Minimum actuating speed $v_{min} = 0.4 \text{ mm/s}$
- Minimum force in the direction of actuation $F_{min} = 30 \text{ N}$

The actuator is encoded. Simple overruling by hand or auxiliary devices is impossible.

Radius actuators

The safety switches with radius actuators are particularly suitable for rotary protective devices. The movable actuation key allows even small radii to be approached. Damage to the switch and the actuator due to inaccurate approach is prevented.

Locking devices

A high-grade steel locking device for attaching up to eight padlocks is available for even more security (see page 13/65).

Dust protection

A rubber cap to protect the actuator entry of the actuator head from contamination is available for operation in dusty environments (see page 13/65).

Tumbler

There are two versions for interlocking the actuator:

- Spring-actuated lock (closed-circuit principle) with various release mechanisms
- Solenoid-locked (open-circuit principle)

The spring-actuated lock switch is equipped with an auxiliary release for emergency situations or setup mode. Available as options:

- Escape release or
- Emergency release

Contact blocks

The safety switches with tumbler have one switching block each for:

- Monitoring the actuator or the position of the protective door
- Monitoring the position of the solenoid

The mechanical design of the switches corresponds to the requirements of the fail-safe principle according to EN ISO 14119.

Optical signaling equipment

The safety switches with tumbler are available with an optional optical signaling device.

The signaling device indicates the switch position of the interlock and the protective device optically by means of 2 LEDs on the front.

Protective device	Tumbler	Display	Meaning
Closed	Released		Actuator able to be pulled
Closed	Locked		Actuator locked
Open	Released		Actuator pulled

Internal wiring:

- The yellow LED is pre-wired to the solenoid monitoring NO contact.
- The green LED is pre-wired to the actuator monitoring NC contact.
- LED ground is pre-wired to the ground of the solenoid.

Note:

- The operational voltage must be connected to the corresponding contacts by the customer.
- This voltage for the LEDs must match the operational voltage of the solenoid (same potential).

General data

Benefits

The new generation of 3SE53 safety switches offers:

- More safety through higher locking forces:
 - 1 300 N with plastic enclosure
 - 2 600 N with metal enclosure
- Various release mechanisms: lock release, escape release and emergency release
- Two contact blocks each with three contacts as standard equipment, hence fewer versions needed
- Same dimensions for all enclosure versions: Plastic, metal or with integrated ASIsafe
- An extensive range of actuators
- An optional LED status display 24 V DC, 115 V or 230 V AC for all switch versions
- Devices with ASIsafe electronics integrated in the enclosure/ wired to 8-pole M12 device plug (see page 13/97).
- 3SE5322-1S.21-1AG4 series with high degree of protection IP69, IP69K in accordance with IEC 60529, cover with foamed seal

Application

The safety switches with tumbler are exceptional safety-related devices which prevent an unforeseen or intentional opening of protective doors, protective grilles or other covers as long as a dangerous situation is present (i.e. follow-on motion of the switched-off machine).

The safety position switches with tumbler have the following functions:

- Enabling the machine or process with closed and locked protective device
- Locking the machine or process with opened protective device
- Position monitoring of the protective device and tumbler

Standards

The switches comply with the standards IEC 60947-1 (Low-Voltage Controlgear, General) and IEC 60947-5-1 (Electromechanical Control Devices).

The mechanical design of the switch corresponds to the requirements of the fail-safe principle according to EN ISO 14119.

Approvals

The switches are approved for use with locking devices according to EN ISO 14119 and EN 292, Parts 1 and 2.

Category 3 according to EN ISO 13849-1 can be attained with a safety switch with tumbler if the corresponding fail-safe evaluation units are selected and correctly installed, e.g. the 3SK or 3TK28 safety relays or matching units from the ASIsafe, SIMATIC or SINUMERIK product ranges.

Category 4 can be achieved when using an additional 3SE5 safety switch.

These switches are approved according to UL 508, UL 50 and UL 746-C.

Tumbler

The separate actuator works like a key using coding and protects against manipulation. It transmits the locking force to the protective device and helps to monitor its position.

There are two versions of locking:

Spring-actuated lock (closed-circuit principle)

- In the standard version, the safety switch locks by means of spring force and releases by means of electromagnetic force. In the case of voltage failure, it reliably prevents the protective device from opening when machine parts are still moving.
- The switch is equipped with an auxiliary release for emergency situations or setup mode.
- An auxiliary release which can be secured with a lock to prevent misuse is available as a version.

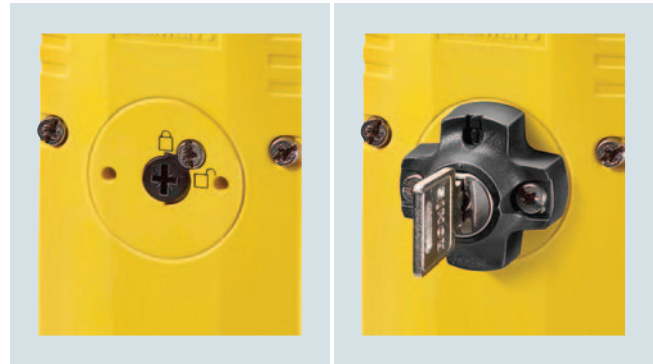

Auxiliary release

Auxiliary release with lock

The 3SE5 3 safety switches are also available with an escape release or emergency release.

- Personnel working inside the hazard zone can use the escape release feature to manually release the tumbler without tools from the escape side (hazardous area side) so that they can exit the hazard area. An intentional act (in this case pulling the gray actuator) is required to release the locking mechanism and restore the normal operating state.
- The emergency release enables someone in an emergency situation to manually release the tumbler without tools from the access side (outside the hazardous area). Releasing the lock and restoring the normal operating state must require effort which is comparable to repair activity: in this case disassembly of the red actuator and resetting of the mechanical lock.

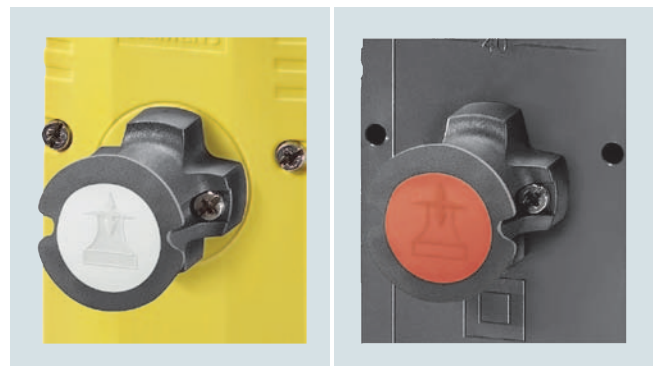

Escape release from the front

Emergency release from the back

Solenoid-locked (open-circuit principle)

- The second version offers locking by means of electromagnetic force and release by means of spring force. This version has an advantage when it is necessary to quickly access the machine after a power failure occurs, or in the case of very short coasting times.

Technical specifications

Type		3SE5322	3SE5312
General data			
Standards		IEC/EN 60947-5-1, EN ISO 14119	
Rated insulation voltage U_i	V	250	
Degree of pollution according to IEC 60664-1		Class 3	
Rated impulse withstand voltage U_{imp}	kV	4	
Rated operational voltage U_e			
• DC	V	24	
• 50/60 Hz AC	V	230	
Conventional thermal current I_{th}	A	6	
Rated operational current I_e			
• With alternating current 50/60 Hz		I_e / AC-15 or B300	
- At 24 V	A	6	
- At 120 V	A	6	
- At 240 V	A	3	
• For direct current		I_e / DC-13 or Q300	
- At 24 V	A	3	
- At 125 V	A	0.55	
- At 250 V	A	0.27	
Solenoid			
• Locking force, max.	N	1 300	2 600
• Locking force acc. to EN ISO 14119	N	1 000	2 000
• Power consumption at U_e	W	3.5	
Short-circuit protection¹⁾			
• With DIAZED fuse links, utilization category gG	A	6	
• With miniature circuit breaker, C char.	A	0.5	
Mechanical endurance	Operating cycles	1×10^6	
Electrical endurance			
• With 3RH.1, 3RT contactors in size S00, S0	Operating cycles	1×10^6	
• For utilization category AC-15 when switching off I_e / AC-15 at 230 V	Operating cycles	100 000	
• With utilization category DC-12/DC-13		For direct current depending on the loading of the switch	
Switching frequency	Operating cycles/h	6 000	
With 3RH.1, 3RT contactors in size S00, S0			
Shock resistance acc. to IEC 60068-2-27	g/ms	30/11	

¹⁾ Without any welds according to IEC 60947-5-1.

Circuit diagrams

Monitoring the actuator

Slow-action contacts 1 NO + 2 NC

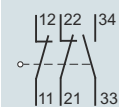

Monitoring the solenoid

Slow-action contacts 1 NO + 2 NC

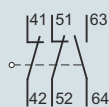

Operating travel

Monitoring the actuator

Slow-action contacts 1 NO + 2 NC

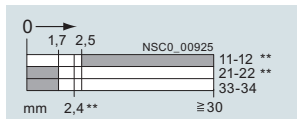







SIRIUS 3SE5, 3SE2 Mechanical Safety Switches

With Tumbler

3SE5, plastic enclosures with locking force greater than 1 200 N

Selection and ordering data

6 slow-action contacts · 5 directions of approach · Degree of protection IP66/IP67 · Cable entry 3 × M20 × 1.5 · Locking force 1 300 N

Tumbler ¹⁾	LEDs	Solenoid, rated operational voltage	SD	Complete units Position monitoring: Actuators: 1 NO + 2 NC Solenoid: 1 NO + 2 NC	PU (UNIT, SET, M)	PS*
				Article No.	Price per PU	
				V	d	
1 300 N locking force · Enclosure width 54 mm						
	Spring-actuated lock					
	• With auxiliary release	--	24 DC	⊕ ▶	3SE5322-0SD21	1 1 unit
		--	115 AC	⊕ 5	3SE5322-0SD22	1 1 unit
		--	230 AC	⊕ 5	3SE5322-0SD23	1 1 unit
		Yellow/Green	24 DC	⊕ 2	3SE5322-1SD21	1 1 unit
		Yellow/Green	115 AC	⊕ 5	3SE5322-2SD22	1 1 unit
	Yellow/Green	230 AC	⊕ 5	3SE5322-3SD23	1 1 unit	
	• With auxiliary release with lock	--	24 DC	⊕ 5	3SE5322-0SE21	1 1 unit
		--	115 AC	⊕ 5	3SE5322-0SE22	1 1 unit
		--	230 AC	⊕ 5	3SE5322-0SE23	1 1 unit
		Yellow/Green	24 DC	⊕ 5	3SE5322-1SE21	1 1 unit
		Yellow/Green	115 AC	⊕ 5	3SE5322-2SE22	1 1 unit
		Yellow/Green	230 AC	⊕ 5	3SE5322-3SE23	1 1 unit
	• With escape release from the front	--	24 DC	⊕ 5	3SE5322-0SF21	1 1 unit
		--	115 AC	⊕ 5	3SE5322-0SF22	1 1 unit
		--	230 AC	⊕ 5	3SE5322-0SF23	1 1 unit
		Yellow/Green	24 DC	⊕ 5	3SE5322-1SF21	1 1 unit
		Yellow/Green	115 AC	⊕ 5	3SE5322-2SF22	1 1 unit
		Yellow/Green	230 AC	⊕ 5	3SE5322-3SF23	1 1 unit
	• With escape release from the front and emergency release from the back	--	24 DC	⊕ 5	3SE5322-0SL21	1 1 unit
	• With escape release from the back and auxiliary release from the front	--	24 DC	⊕ 5	3SE5322-0SG21	1 1 unit
		--	115 AC	⊕ 5	3SE5322-0SG22	1 1 unit
		--	230 AC	⊕ 5	3SE5322-0SG23	1 1 unit
		Yellow/Green	24 DC	⊕ 5	3SE5322-1SG21	1 1 unit
		Yellow/Green	115 AC	⊕ 5	3SE5322-2SG22	1 1 unit
	Yellow/Green	230 AC	⊕ 5	3SE5322-3SG23	1 1 unit	
	• With escape release from the back and auxiliary release with lock from the front	--	24 DC	⊕ 5	3SE5322-0SH21	1 1 unit
	• With emergency release from the back and auxiliary release from the front	--	24 DC	⊕ 5	3SE5322-0SJ21	1 1 unit
		--	115 AC	⊕ 5	3SE5322-0SJ22	1 1 unit
		--	230 AC	⊕ 5	3SE5322-0SJ23	1 1 unit
		Yellow/Green	24 DC	⊕ 5	3SE5322-1SJ21	1 1 unit
		Yellow/Green	115 AC	⊕ 5	3SE5322-2SJ22	1 1 unit
	Yellow/Green	230 AC	⊕ 5	3SE5322-3SJ23	1 1 unit	
	Solenoid-locked	--	24 DC	⊕ ▶	3SE5322-0SB21	1 1 unit
		--	115 AC	⊕ 5	3SE5322-0SB22	1 1 unit
		--	230 AC	⊕ 5	3SE5322-0SB23	1 1 unit
	• With device plug, 8-pole Head rotated clockwise by 90°	Yellow/Green	24 DC	NEW ⊕ 5	3SE5334-0SB21-1AC8	1 1 unit
		Yellow/Green	24 DC	NEW ⊕ 5	3SE5324-0SB21-1AP0	1 1 unit
		Yellow/Green	24 DC	⊕ 2	3SE5322-1SB21	1 1 unit
	Yellow/Green	115 AC	⊕ 5	3SE5322-2SB22	1 1 unit	
	Yellow/Green	230 AC	⊕ 5	3SE5322-3SB23	1 1 unit	

⊕ Positive opening according to IEC 60947-5-1, Appendix K.

¹⁾ Supplied without actuator. Please order separately (see page 13/64).

SIRIUS 3SE5, 3SE2 Mechanical Safety Switches

With Tumbler

3SE5, plastic enclosures with locking force greater than 1 200 N

6 slow-action contacts · 5 directions of approach · **Degree of protection IP69K** · Cable entry 3 × M20 × 1.5 · Locking force 1 300 N

- With foamed seal and special cover

Tumbler ¹⁾	LEDs	Solenoid, rated operational voltage	SD	Complete units Position monitoring: Actuators: 1 NO + 2 NC Solenoid: 1 NO + 2 NC	PU (UNIT, SET, M)	PS*
		V	d	Article No.	Price per PU	

1 300 N locking force · Enclosure width 54 mm · Degree of protection IP69K

Spring-actuated locks

- With auxiliary release

Yellow/Green 24 DC ⊕ 5

3SE5322-1SD21-1AG4 1 1 unit



3SE5322-1SD21-1AG4

- With auxiliary release with lock

Yellow/Green 24 DC ⊕ 5

3SE5322-1SE21-1AG4 1 1 unit



3SE5322-1SE21-1AG4

- With escape release from the front

Yellow/Green 24 DC ⊕ 5

3SE5322-1SF21-1AG4 1 1 unit



3SE5322-1SF21-1AG4

- With escape release from the back and auxiliary release from the front

Yellow/Green 24 DC ⊕ 5

3SE5322-1SG21-1AG4 1 1 unit



3SE5322-1SG21-1AG4

⊕ Positive opening according to IEC 60947-5-1, Appendix K.

¹⁾ Supplied without actuator. Please order separately (see page 13/64).

Accessories

Version	SD	Article No.	Price per PU	PU (UNIT, SET, M)	PS*
	d				

Accessories

Cable glands M20 × 1.5
Plastic
High degree of protection IP69, IEC 60529

5 **3SX5601-1A** 1 1 unit



3SX5601-1A





SIRIUS 3SE5, 3SE2 Mechanical Safety Switches

With Tumbler

3SE5, metal enclosures with locking force greater than 2 000 N

Selection and ordering data

6 slow-action contacts · 5 directions of approach · Degree of protection IP66/IP67 · Cable entry 3 × M20 × 1.5 · Locking force 2 600 N

Tumbler ¹⁾	LEDs	Solenoid, rated operational voltage	SD	Complete units Position monitoring: Actuators: 1 NO + 2 NC Solenoid: 1 NO + 2 NC Article No.	<input type="checkbox"/>	PU (UNIT, SET, M)	PS*
		V	d			Price per PU	
2 600 N locking force · Enclosure width 54 mm							
Spring-actuated locks							
	• With auxiliary release	--	24 DC	⊕ ▶	3SE5312-0SD11		1 1 unit
		--	115 AC	⊕	3SE5312-0SD12		1 1 unit
		--	230 AC	⊕	3SE5312-0SD13		1 1 unit
		Yellow/Green	24 DC	⊕	3SE5312-1SD11		1 1 unit
		Yellow/Green	115 AC	⊕	3SE5312-2SD12		1 1 unit
		Yellow/Green	230 AC	⊕	3SE5312-3SD13		1 1 unit
	• With auxiliary release with lock	--	24 DC	⊕	3SE5312-0SE11		1 1 unit
		--	115 AC	⊕	3SE5312-0SE12		1 1 unit
		--	230 AC	⊕	3SE5312-0SE13		1 1 unit
		Yellow/Green	24 DC	⊕	3SE5312-1SE11		1 1 unit
		Yellow/Green	115 AC	⊕	3SE5312-2SE12		1 1 unit
		Yellow/Green	230 AC	⊕	3SE5312-3SE13		1 1 unit
	• With escape release from the front	--	24 DC	⊕	3SE5312-0SF11		1 1 unit
		--	115 AC	⊕	3SE5312-0SF12		1 1 unit
		--	230 AC	⊕	3SE5312-0SF13		1 1 unit
		Yellow/Green	24 DC	⊕	3SE5312-1SF11		1 1 unit
		Yellow/Green	115 AC	⊕	3SE5312-2SF12		1 1 unit
		Yellow/Green	230 AC	⊕	3SE5312-3SF13		1 1 unit
	• With escape release from the back and auxiliary release from the front	--	24 DC	⊕	3SE5312-0SG11		1 1 unit
		--	115 AC	⊕	3SE5312-0SG12		1 1 unit
		--	230 AC	⊕	3SE5312-0SG13		1 1 unit
		Yellow/Green	24 DC	⊕	3SE5312-1SG11		1 1 unit
		Yellow/Green	115 AC	⊕	3SE5312-2SG12		1 1 unit
		Yellow/Green	230 AC	⊕	3SE5312-3SG13		1 1 unit
	• With escape release from the back and auxiliary release with lock from the front	--	24 DC	⊕	3SE5312-0SH11		1 1 unit
	• With emergency release from the back and auxiliary release from the front	--	24 DC	⊕	3SE5312-0SJ11		1 1 unit
		--	115 AC	⊕	3SE5312-0SJ12		1 1 unit
		--	230 AC	⊕	3SE5312-0SJ13		1 1 unit
		Yellow/Green	24 DC	⊕	3SE5312-1SJ11		1 1 unit
		Yellow/Green	115 AC	⊕	3SE5312-2SJ12		1 1 unit
		Yellow/Green	230 AC	⊕	3SE5312-3SJ13		1 1 unit
	Solenoid-locked	--	24 DC	⊕ ▶	3SE5312-0SB11		1 1 unit
		--	115 AC	⊕	3SE5312-0SB12		1 1 unit
		--	230 AC	⊕	3SE5312-0SB13		1 1 unit
		Yellow/Green	24 DC	⊕	3SE5312-1SB11		1 1 unit
		Yellow/Green	115 AC	⊕	3SE5312-2SB12		1 1 unit
	Yellow/Green	230 AC	⊕	3SE5312-3SB13		1 1 unit	

⊕ Positive opening according to IEC 60947-5-1, Appendix K.









¹⁾ Supplied without actuator. Please order separately (see page 13/64).

SIRIUS 3SE5, 3SE2 Mechanical Safety Switches

With Tumbler

Accessories

Selection and ordering data

Version	SD	Article No.	Price per PU	PU (UNIT, SET, M)	PS*
IP66/IP67					
 3SE5000-0AV01		Standard actuator			
		<ul style="list-style-type: none"> Length 75.6 mm 	▶	3SE5000-0AV01	1 1 unit
	5	<ul style="list-style-type: none"> With vertical fixing, length 53 mm 		3SE5000-0AV02	1 1 unit
 3SE5000-0AV02	5	<ul style="list-style-type: none"> With transverse fixing, length 47 mm 		3SE5000-0AV03	1 1 unit
	5	<ul style="list-style-type: none"> With vertical fixing, length 53 mm 		3SE5000-0AW51	1 1 unit
 3SE5000-0AV03	5	High-grade steel actuator, IP69K¹⁾			
		<ul style="list-style-type: none"> Length 75.6 mm 		3SE5000-0AW51	1 1 unit
	5	<ul style="list-style-type: none"> With vertical fixing, length 53 mm 		3SE5000-0AW52	1 1 unit
 3SE5000-0AW51	5	<ul style="list-style-type: none"> With transverse fixing, length 47 mm 		3SE5000-0AW53	1 1 unit
	5	<ul style="list-style-type: none"> With vertical fixing, length 53 mm 		3SE5000-0AV04	1 1 unit
 3SE5000-0AW52	5	<ul style="list-style-type: none"> With transverse fixing, length 47 mm 		3SE5000-0AV06	1 1 unit
	5	<ul style="list-style-type: none"> With transverse fixing, length 47 mm 		3SE5000-0AV05	1 1 unit
 3SE5000-0AV06	2	Radius actuator, length 51 mm			
	5	<ul style="list-style-type: none"> Direction of approach from the left Direction of approach from the right 		3SE5000-0AV04	1 1 unit
 3SE5000-0AV05	5	Universal radius actuator			
	5	<ul style="list-style-type: none"> Length 77 mm Length 77 mm, tab rotated 90° 		3SE5000-0AV05	1 1 unit
 3SE5000-0AV05-1AA6	2	Universal radius actuator, heavy duty			
	5	<ul style="list-style-type: none"> Length 67 mm Length 77 mm 		3SE5000-0AV07-1AK2	1 1 unit
 3SE5000-0AV07	5			3SE5000-0AV07	1 1 unit





For further plug versions, [see page 13/46](#).

¹⁾ With optimized geometry and suitable for extreme environmental conditions such as -40 °C

SIRIUS 3SE5, 3SE2 Mechanical Safety Switches

With Tumbler

Accessories

Version	SD	Article No.	Price per PU	PU (UNIT, SET, M)	PS*
Optional accessories for 3SE5					
 3SE5000-0AV08-1AA2		Protective caps, black rubber For the actuator head, to protect the actuator openings from contamination	5	3SE5000-0AV08-1AA2	1 1 unit
 3SE5000-0AV08-1AA3		Blocking inserts, high-grade steel, for actuator head For up to eight padlocks	5	3SE5000-0AV08-1AA3	1 1 unit
Spare parts for 3SE5					
		Spare keys	5	3SX5100-1F	1 1 unit
Connection for 3SE5					
 3SY3127		Device plugs (4-pole), M12, fixed for M20 x 1.5 For max. 250 V, 4 A With connecting cable 0.25 mm ² , plastic, degree of protection IP67, ambient temperature -40 to +85 °C	5	3SY3127	1 1 unit
		Device plugs (5-pole), M12, fixed for M20 x 1.5 For max. 125 V, 4 A With connecting cable 0.25 mm ² , plastic, degree of protection IP67, ambient temperature -40 to +85 °C	5	3SY3128	1 1 unit
 3SX9926		Cable glands M20 x 1.5 Plastic			
	2	• Degree of protection IP67		3SX9926	1 1 unit
	5	• High degree of protection IP69, IEC 60529		3SX5601-1A	1 1 unit

For further plug versions, [see page 13/46](#).

General data

Overview

3SE5 hinge switches have the same enclosures as the 3SE5 position switches (modular system).



Hinge switches

Design

Enclosure sizes

The 3SE5 switches are available as complete units in two enclosure sizes:

- Plastic enclosures according to EN 50047, 31 mm wide, IP65, 1 cable entry
- Metal enclosures according to EN 50047, 31 mm wide, IP66/IP67, 1 cable entry
- Plastic and metal enclosures according to EN 50041, 40 mm wide, IP66/IP67, 1 cable entry

Enclosure versions

Various basic versions can be selected for the enclosures:

- With two or three-pole switching elements designed as snap-action contacts
- AS-Interface version with integrated ASIsafe electronics for all enclosure designs (see page 13/100).

For a description of the basic switches, (see page 13/7).

Operating mechanism

The hinge switches are provided for mounting on hinges. The actuator head is included in the scope of supply. There are two versions:

- Operating mechanism with hollow shaft, inner diameter 8 mm, outer 12 mm
- Operating mechanism with solid shaft, diameter 10 mm

3SE2283 hinge switches

The 3SE2283 hinge switches with integrated hinge are available in a special design. They are particularly suitable for use in machine doors and flaps.

Benefits

The 3SE5 hinge switches differ from the previous series through the following new characteristics:

- All actuators can be turned around the axis in increments of 22.5° (see picture, page 13/8).
- The new three-pole contact block 1 NO + 2 NC is available for all enclosure sizes (see picture, page 13/8).
- The plastic enclosure with a width of 31 mm has simple and fast wiring equipment which makes it possible to save approx. 20 to 25% of the time when connecting (see picture, page 13/8).
- The ASIsafe electronics are integrated in the enclosure for the versions with AS-Interface connection (see page 13/85); an additional adapter is not required.

Application

The hinge switches are used in those areas where the position of swiveling protective devices such as doors or flaps must be monitored. With these switches, the position of the doors and flaps is converted into electric signals. The switches allow shutdown and signaling without delay in the event of a small opening angle through the snap-action contacts with an operating angle of 10°.

Devices are available with enclosure versions to suit the particular ambient conditions. Different control tasks can be performed with the contact blocks best suited for the particular purpose. Dimensions and fixing points of the enclosures are in accordance with EN 50041 or EN 50047 standards.

The devices are suitable for use in any climate.

Standards

IEC/EN 60947-5-1

The protective measure of "total insulation" by the plastic enclosure is ensured by the use of molded-plastic screw glands.

Safety position switches

For controls according to IEC/EN 60204-1, the devices can be used as a safety position switch. To secure position switches against changes in their position, keyed techniques must be employed on installation.

Safety circuits

The IEC/EN 60947-5-1 standard requires positive opening of the NC contacts. In other words, for the purposes of personal safety, the assured opening of NC contacts is expressly stipulated for the electrical equipment of machines in all safety circuits and marked in accordance with IEC 60947-5-1 with the symbol \ominus .

Category 4 according to EN ISO 13849-1 can be attained with the 3SE5 hinge switches with \ominus if the corresponding fail-safe evaluation units are selected and correctly installed, e.g. the 3SK or 3TK28 safety relays or matching devices from the ASIsafe, SIMATIC or SINUMERIK product ranges.

SIRIUS 3SE5, 3SE2 Mechanical Safety Hinge Switches

3SE5, Plastic Enclosures

Enclosure width 31 mm acc. to EN 50047 / 40 mm according to EN 50041





Technical specifications

The technical specifications are the same as for the standard switches, (see page 13/11).

Selection and ordering data

Complete units



2 or 3 contacts · Degree of protection IP65 (31 mm) or IP67/IP68 (40 mm) · Cable entry M20 × 1.5

Version	Snap-action contacts	SD	Complete units	Price per PU	PU (UNIT, SET, M)	PS*
		d	Article No.			
Plastic enclosures · Enclosure width 31 mm acc. to EN 50047						
	With hollow shaft					
	Operating angle 10°	1 NO + 1 NC ¹⁾	⊕ 5	3SE5232-0HU21	1	1 unit
	Operating angle 10°	1 NO + 2 NC	⊕ 5	3SE5232-0LU21	1	1 unit
3SE5232-0HU21						
	With solid shaft					
	Operating angle 10°	1 NO + 1 NC ¹⁾	⊕ 5	3SE5232-0HU22	1	1 unit
	Operating angle 10°	1 NO + 2 NC	⊕ 5	3SE5232-0LU22	1	1 unit
3SE5232-0HU22						
Plastic enclosures · Enclosure width 40 mm acc. to EN 50041						
	With hollow shaft					
	Operating angle 10°	1 NO + 2 NC	⊕ 5	3SE5132-0LU21	1	1 unit
3SE5132-0LU21						
	With solid shaft					
	Operating angle 10°	1 NO + 2 NC	⊕ 5	3SE5132-0LU22	1	1 unit
3SE5132-0LU22						

⊕ Positive opening according to IEC 60947-5-1, Appendix K.

¹⁾ Contact blocks permanently integrated, replacement not available.

Spare parts

Version	SD	Article No.	Price per PU	PU (UNIT, SET, M)	PS*
	d				
Actuator heads					
					
		With hollow shaft			
	5	Operating angle 10°	3SE5000-0AU21	1	1 unit
3SE5000-0AU21					
					
		With solid shaft			
	5	Operating angle 10°	3SE5000-0AU22	1	1 unit
3SE5000-0AU22					

Note: The respective actuators are included in the scope of supply for the complete units.

SIRIUS 3SE5, 3SE2 Mechanical Safety Hinge Switches

3SE5, Plastic Enclosures

Enclosure width 31 mm acc. to EN 50047 / 40 mm according to EN 50041

Selection and ordering data

Complete units

3 contacts · Degree of protection IP66/IP67 · Cable entry M20 × 1.5

Version	Snap-action contacts	SD	Complete units	PU (UNIT, SET, M)	PS*
		d	Article No.	Price per PU	

Metal enclosures · Enclosure width 31 mm acc. to EN 50047



3SE5212-0LU21

With hollow shaft

Operating angle 10°

1 NO + 2 NC

⊕ 5

3SE5212-0LU21

1 1 unit



3SE5212-0LU22

With solid shaft

Operating angle 10°

1 NO + 2 NC

⊕ 5

3SE5212-0LU22

1 1 unit

Metal enclosures · Enclosure width 40 mm acc. to EN 50041



3SE5112-0LU21

With hollow shaft

Operating angle 10°

1 NO + 2 NC

⊕ 5

3SE5112-0LU21

1 1 unit



3SE5112-0LU22

With solid shaft

Operating angle 10°

1 NO + 2 NC

⊕ 5

3SE5112-0LU22

1 1 unit

⊕ Positive opening according to IEC 60947-5-1, Appendix K.

Spare parts

Version	SD	Article No.	Price per PU	PU (UNIT, SET, M)	PS*
	d				

Actuator heads



3SE5000-0AU21

With hollow shaft

Operating angle 10°

5

3SE5000-0AU21

1 1 unit



3SE5000-0AU22

With solid shaft

Operating angle 10°

5

3SE5000-0AU22

1 1 unit

Note: The respective actuators are included in the scope of supply for the complete units.

Overview

The 3SE2283 hinge switches with built-in hinge are particularly suitable for use in doors and flaps of machines that must be closed to ensure the safety of operating personnel. Their thin profile and the compact design allow them to be directly mounted on a hinged protective cover and the stable frame.

Benefits

- Easy mounting through use of versions with integrated hinge
- Versions with small operating angle of 4° or 8°
- Protection against personal injury provided by positively driven NC contacts according to IEC 60947-5-1
- Simultaneous shutdown and signaling by 1 NO + 2 NC contacts

Technical specifications

Type	3SE2283	
Rated insulation voltage U_i	V	250
Conventional thermal current I_{th}	A	2.5
Rated operational current I_e		
• At AC-15, 120 V	A	4.2
• At AC-15, 250 V	A	2
• At DC-13, 24 V	A	1
Min. make-break capacity	> 5 V/1 mA	
Short-circuit protection		
• Operational class gG	A	2
Mechanical endurance	> 1×10^6 operating cycles	
Switching frequency	1 200 operating cycles/h	
Positive opening	2 mm after opening point	
Enclosure material	Plastic	
Degree of protection	IP65	
Ambient temperature	°C	-25 ... +65
Shock resistance	30 g/18 ms	
Resistance to vibrations	20 g/10 ... 200 Hz	
Cable entry	2 × (M20 × 1.5)	
Screw terminals	0.5 ... 1.5 mm ² / AWG 15	

SIRIUS 3SE5, 3SE2 Mechanical Safety Hinge Switches

3SE2, Plastic Enclosures

With integrated hinge

Selection and ordering data

3 contacts · Degree of protection IP65 · Cable entry 2 × (M20 × 1.5)

Version	Slow-action contacts	SD	Complete units	Price per PU	PU (UNIT, SET, M)	PS*
		d	Article No.			

Plastic enclosures with integrated hinge



3SE2283

With integrated hinge

(Scope of supply includes additional hinge and fixing accessories)

- Aluminum hinge

- 4° actuating angle	1 NO + 2 NC	⊕ 15	3SE2283-0GA43		1	1 unit
- 4° actuating angle	3 NC	⊕ 5	3SE2283-6GA43		1	1 unit
- 8° actuating angle	1 NO + 2 NC	⊕ 10	3SE2283-0GA53		1	1 unit
- 8° actuating angle	3 NC	⊕ 15	3SE2283-6GA53		1	1 unit

- High-grade steel hinge

- 4° actuating angle	1 NO + 2 NC	⊕ 5	3SE2283-0GA44		1	1 unit
----------------------	-------------	-----	----------------------	--	---	--------

⊕ Positive opening according to IEC 60947-5-1, Appendix K.

Accessories/spare parts

Version	SD	Article No.	Price per PU	PU (UNIT, SET, M)	PS*
	d				

Accessories



3SX3225

Additional hinge

(Scope of supply includes fixing accessories)

- Made of aluminum

10	3SX3225			1	1 unit
----	----------------	--	--	---	--------

SIRIUS 3SE5 Mechanical Position Switches for Ambient Temperatures down to -40 °C

SIRIUS 3SE5 Mechanical Position Switches, Shock and Vibration Test

3SE5, plastic enclosures, enclosure width 31 mm according to EN 50047





Selection and ordering data

Complete units

2 or 3 contacts · Degree of protection IP65 or IP66/IP67 · Cable entry M20 × 1.5, with increased corrosion protection

Version	Contacts	SD	Complete units	<input type="checkbox"/>	PU (UNIT, SET, M)	PS*
		d	Article No.	Price per PU		

Complete units¹⁾ · Enclosure width 31 mm

	Twist levers, 21 mm long, acc. to EN 50047 With plastic roller 19 mm Snap-action contacts	1 NO + 2 NC	⊕ 5	3SE5232-0LK21-1AY0	1	1 unit
3SE5232-0LK21-1AY0						
	Roller levers, acc. to EN 50047 With plastic roller 13 mm Snap-action contacts	1 NO + 2 NC	⊕ 5	3SE5232-0LE10-1AY0	1	1 unit
3SE5232-0LE10-1AY0						
	Rod actuators, acc. to EN 50047 Plastic rod, length 200 mm Snap-action contacts	1 NO + 1 NC	30	3SE5232-0HK82-1AY0	1	1 unit
3SE5232-0HK82-1AY0						
	Spring rod Snap-action contacts	1 NO + 1 NC	30	3SE5232-0HR01-1AY0	1	1 unit
3SE5232-0HR01-1AY0						

⊕ Positive opening according to IEC 60947-5-1, Appendix K, or positively driven actuator, necessary in safety circuits.

¹⁾ Popular versions.

SIRIUS 3SE5 Mechanical Position Switches for Ambient Temperatures down to -40 °C

SIRIUS 3SE5 Mechanical Safety Switches with Tumbler, Shock & Vibration Test

3SE5, plastic enclosures, enclosure width 54 mm

Selection and ordering data

6 slow-action contacts · 5 directions of approach · Degree of protection IP66/IP67 · Cable entry 3 × M20 × 1.5 · Locking force 1 300 N

Tumbler ¹⁾	Solenoid, rated operational voltage	SD	Complete units Position monitoring: Actuators: 1 NO + 2 NC Solenoid: 1 NO + 2 NC	<input type="checkbox"/>	PU (UNIT, SET, M)	PS*
	V	d	Article No.	Price per PU		

1 300 N locking force · Enclosure width 54 mm

Spring-actuated locks

- With front auxiliary release

24 DC

⊕ 5

3SE5322-0SD21-1AY0

1 1 unit



3SE5322-0SD21-1AY0

⊕ Positive opening according to IEC 60947-5-1, Appendix K.

¹⁾ Supplied without actuator. Please order separately.

Accessories/spare parts

Version	SD	Article No.	Price per PU	PU (UNIT, SET, M)	PS*
	d				

Accessories



Standard actuator

- Length 75.6 mm

3SE5000-0AV01

3SE5000-0AV01

1 1 unit



High-grade steel actuator, standard, IP69K¹⁾

- Length 75.6 mm

3SE5000-0AW51

5

3SE5000-0AW51

1 1 unit



- With vertical fixing, length 53 mm

3SE5000-0AW52

5

3SE5000-0AW52

1 1 unit



- With transverse fixing, length 47 mm

3SE5000-0AW53

5

3SE5000-0AW53

1 1 unit

¹⁾ With optimized geometry and suitable for extreme environmental conditions such as -40 °C

SIRIUS 3SE5 Mechanical Position Switches for Ambient Temperatures down to -40 °C

SIRIUS 3SE5 Mechanical Safety Hinge Switches, Shock and Vibration Test

3SE5, plastic enclosures, enclosure width 31 mm according to EN 50047

Selection and ordering data

With increased corrosion protection

Version	Contacts	SD	Complete units	PU (UNIT, SET, M)	PS*
		d	Article No.	Price per PU	

Complete units¹⁾ • Enclosure width 31 mm



Hinge switches, acc. to EN 50047

With hollow shaft D = 8 mm, operating angle 10 degrees,

Snap-action contacts

1 NO + 1 NC

⊕ 30

3SE5232-0HU21-1AY0

1 1 unit

3SE5232-0HU21-1AY0

⊕ Positive opening according to IEC 60947-5-1, Appendix K.

¹⁾ With optimized geometry and suitable for extreme environmental conditions such as -40 °C

SIRIUS 3SE5 Mechanical Position Switches for Ambient Temperatures down to -40 °C

SIRIUS 3SE5 Mechanical Position Switches, Shock & Vibration Railway Standard

3SE5, plastic enclosures, enclosure width 31 mm according to EN 50047 / 50 mm





Selection and ordering data

Complete units



2 or 3 contacts · Degree of protection IP65 or IP66/IP67 · Cable entry M20 × 1.5, with increased corrosion protection

Version	Contacts	LEDs	SD	Complete units	PU (UNIT, SET, M)	PS*
			d	Article No.	Price per PU	

Complete units¹⁾ • Enclosure width 31 mm

	Roller plungers, type C, acc. to EN 50047 With plastic roller 10 mm, with M12 device plug, 4-pole (250 V, 4 A)					
	Snap-action contacts	1 NO + 1 NC --	⊕ 5	3SE5234-0CD03-1AJ1		1 1 unit
3SE5234-0CD03-1AJ1						
	Roller plungers with central fixing					
	Snap-action contacts	1 NO + 1 NC --	⊕ 5	3SE5232-0CD10-1AJ0		1 1 unit
3SE5232-0CD10-1AJ0						
	Twist levers, type A, acc. to EN 50047 With high-grade steel lever 21 mm and plastic roller 19 mm					
	Snap-action contacts	1 NO + 1 NC --	⊕ 2	3SE5232-0CK31-1AJ0		1 1 unit
3SE5232-0CK31-1AJ0						
	Twist levers, adjustable length With high-grade steel lever with grid hole and plastic roller 19 mm					
	Snap-action contacts	1 NO + 1 NC --	⊕ 5	3SE5232-0CK62-1AJ0		1 1 unit
	Snap-action contacts	1 NO + 2 NC --	⊕ 5	3SE5232-0LK62-1AJ0		1 1 unit
3SE5232-0CK62-1AJ0						

Complete units¹⁾ • Enclosure width 50 mm

	Twist levers With metal lever 21 mm and plastic roller 19 mm					
	Snap-action contacts, integrated ²⁾	1 NO + 1 NC --	⊕ 5	3SE5242-0HK21-1AJ0		1 1 unit
	Twist levers, adjustable length With high-grade steel lever with grid hole and plastic roller 19 mm					
	Snap-action contacts, integrated ²⁾	1 NO + 1 NC --	⊕ 5	3SE5242-0HK62-1AJ0		1 1 unit
3SE5242-0HK21-1AJ0						

⊕ Positive opening according to IEC 60947-5-1, Appendix K, or positively driven actuator, necessary in safety circuits.

1) Popular versions.

2) Subsequent replacement of contact blocks is not possible.

Note:

If the device you require is not available as a complete unit, see [Modular system, page 13/75](#).



SIRIUS 3SE5 Mechanical Position Switches for Ambient Temperatures down to -40 °C

SIRIUS 3SE5 Mechanical Position Switches, Shock & Vibration Railway Standard

3SE5, plastic enclosures, enclosure width 31 mm according to EN 50047 / 50 mm

Modular system

2 or 3 contacts · Degree of protection IP65 or IP66/IP67 · Cable entry M20 × 1.5, with increased corrosion protection

Version	Contacts	LEDs	SD	Modular system	PU (UNIT, SET, M)	PS*
			d	Article No.	Price per PU	
Basic switches • Enclosure width 31 mm (with rounded plunger¹⁾)						
With teflon plunger						
	Snap-action contacts	1 NO + 1 NC --	⊕ 5	3SE5232-0CC05-1AJ0		1 1 unit
	Slow-action contacts	1 NO + 2 NC --	⊕ 5	3SE5232-0KC05-1AJ0		1 1 unit
	Snap-action contacts	1 NO + 2 NC --	⊕ 5	3SE5232-0LC05-1AJ0		1 1 unit
3SE5232-0CC05-1AJ0						
Basic switches • Enclosure width 50 mm (with rounded plunger¹⁾)						
With teflon plunger						
	Slow-action contacts	1 NO + 1 NC --	⊕ 5	3SE5242-0BC05-1AJ0		1 1 unit
	Snap-action contacts, integrated ²⁾	1 NO + 1 NC --	⊕ 5	3SE5242-0HC05-1AJ0		1 1 unit
3SE5242-0BC05-1AJ0						

⊕ Positive opening according to IEC 60947-5-1, Appendix K, or positively driven actuator, necessary in safety circuits.

1) For enclosures with widths of 31 and 50 mm, the basic switch is a complete unit with rounded plungers.

2) Subsequent replacement of contact blocks is not possible.





Note:

For the selection aid, see page 13/13

SIRIUS 3SE5 Mechanical Position Switches for Ambient Temperatures down to -40 °C

SIRIUS 3SE5 Mechanical Position Switches, Shock & Vibration Railway Standard

3SE5, plastic enclosures, enclosure width 31 mm according to EN 50047 / 50 mm

Version	Diameter	SD	Modular system	PU (UNIT, SET, M)	PS*
	mm	d	Article No.	Price per PU	
Operating mechanisms					
	Roller plungers, type C, acc. to EN 50047				
3SE5000-0AD03	Plastic roller	10	⊕ 5	3SE5000-0AD03-1AJ0	1 1 unit
Roller levers, type E, acc. to EN 50047					
	Metal lever, plastic roller	13	⊕ 5	3SE5000-0AE10-1AJ0	1 1 unit
	High-grade steel lever, plastic roller	13	⊕ 5	3SE5000-0AE12-1AJ0	1 1 unit
	High-grade steel lever, high-grade steel roller	13	⊕ 5	3SE5000-0AE13-1AJ0	1 1 unit
Angular roller levers					
	Metal lever, plastic roller	13	⊕ 5	3SE5000-0AF10-1AJ0	1 1 unit
3SE5000-0AF10-1AJ0	High-grade steel lever, plastic roller	13	⊕ 5	3SE5000-0AF12-1AJ0	1 1 unit
Twist actuators					
	Twist actuators, for 31 mm/50 mm, EN 50047				
3SE5000-0AK00-1AJ0	Switching right and/or left, adjustable		⊕ 5	3SE5000-0AK00-1AJ0	1 1 unit
Levers					
Twist levers straight, 21 mm, type A acc. to EN 50047					
	Metal lever, plastic roller	19	⊕ 5	3SE5000-0AA21-1AJ0	1 1 unit
3SE5000-0AA21-1AJ0	High-grade steel lever, plastic roller	19	⊕ 5	3SE5000-0AA31-1AJ0	1 1 unit
	High-grade steel lever, high-grade steel roller	19	⊕ 5	3SE5000-0AA32-1AJ0	1 1 unit
Twist levers, adjustable length, with grid hole					
	Metal lever, plastic roller	19	⊕ 5	3SE5000-0AA60-1AJ0	1 1 unit
3SE5000-0AA60-1AJ0	High-grade steel lever, plastic roller	19	⊕ 5	3SE5000-0AA62-1AJ0	1 1 unit

⊕ Positively driven actuator, necessary in safety circuits.

Selection and ordering data

Modular system

2 or 3 contacts · Degree of protection IP66/IP67 · Cable entry M20 × 1.5, with increased corrosion protection

Version	Contacts	LEDs	SD	Modular system	PU (UNIT, SET, M)	PS*
			d	Article No.	Price per PU	

Basic switches • Enclosure width 40 mm



With connecting thread M20 × 1.5

Snap-action contacts	1 NO + 1 NC	--	⊕ 5	3SE5132-0CA00-1AJ0	1	1 unit
Slow-action contacts	1 NO + 2 NC	--	⊕ 5	3SE5132-0KA00-1AJ0	1	1 unit
Snap-action contacts	1 NO + 2 NC	--	⊕ 5	3SE5132-0LA00-1AJ0	1	1 unit

3SE5132-0CA00-1AJ0

⊕ Positively opening according to IEC 60947-5-1, Appendix K, or positively driven actuator, necessary in safety circuits.

Note:

For the selection aid, see page 13/13

Version	Diameter	SD	Modular system	PU (UNIT, SET, M)	PS*
	mm	d	Article No.	Price per PU	

Operating mechanisms



Rounded plungers, type B, acc. to EN 50041

Plastic plungers	10	⊕ 5	3SE5000-0AC03-1AJ0	1	1 unit
------------------	----	-----	---------------------------	---	--------

3SE5000-0AC03-1AJ0



Roller plungers, type C, acc. to EN 50041

Plastic plunger, plastic roller	13	⊕ 5	3SE5000-0AD05-1AJ0	1	1 unit
---------------------------------	----	-----	---------------------------	---	--------

3SE5000-0AD05-1AJ0



Roller levers

Metal lever with plastic roller, plastic base	22	⊕ 5	3SE5000-0AE05-1AJ0	1	1 unit
---	----	-----	---------------------------	---	--------

3SE5000-0AE05-1AJ0

Twist actuators



Twist actuators, for 31 mm/50 mm, EN 50047

• For twist levers and rod actuators, switching right and/or left, adjustable		⊕ 5	3SE5000-0AH00-1AJ0	1	1 unit
---	--	-----	---------------------------	---	--------

3SE5000-0AH00-1AJ0

Levers

Twist levers, type A, acc. to EN 50041

Metal lever, plastic roller	19	⊕ 5	3SE5000-0AA01-1AJ0	1	1 unit
High-grade steel lever, plastic roller	19	⊕ 5	3SE5000-0AA11-1AJ0	1	1 unit

3SE5000-0AA01-1AJ0

Twist levers, adjustable length, with grid hole

Metal lever, plastic roller	19	⊕ 5	3SE5000-0AA60-1AJ0	1	1 unit
High-grade steel lever, plastic roller	19	⊕ 5	3SE5000-0AA62-1AJ0	1	1 unit

3SE5000-0AA60-1AJ0

⊕ Positively driven actuator, necessary in safety circuits.

SIRIUS 3SE5 Mechanical Position Switches for Ambient Temperatures down to -40 °C

SIRIUS 3SE5 Mechanical Position Switches, Shock & Vibration Railway Standard

3SE5, metal enclosures, enclosure width 31 mm according to EN 50047

Selection and ordering data

Complete units

2 or 3 contacts · Degree of protection IP66/IP67 · Cable entry M20 × 1.5, with increased corrosion protection

Version	Contacts	LEDs	SD	Modular system	PU (UNIT, SET, M)	PS*
			d	Article No.	Price per PU	

Complete units · Enclosure width 31 mm

Rounded plungers, type B, acc. to EN 50047

Snap-action contacts	1 NO + 1 NC --	⊕	5	3SE5212-0CC05-1AJ0	1	1 unit
Slow-action contacts	1 NO + 2 NC --	⊕	5	3SE5212-0KC05-1AJ0	1	1 unit
Snap-action contacts	1 NO + 2 NC --	⊕	5	3SE5212-0LC05-1AJ0	1	1 unit



3SE5212-0CC05-1AJ0

Twist levers, type A, acc. to EN 50047

With metal lever 21 mm and high-grade steel roller 19 mm, twist actuator for 40 mm

Snap-action contacts	1 NO + 1 NC --	⊕	5	3SE5212-0CH22-1AJ0	1	1 unit
----------------------	----------------	---	---	---------------------------	---	--------



3SE5212-0CH22-1AJ0

⊕ Positive opening according to IEC 60947-5-1, Appendix K, or positively driven actuator, necessary in safety circuits.

Note:

If the device you require is not available as a complete unit, see [Modular system, page 13/77](#).

SIRIUS 3SE5 Mechanical Position Switches for Ambient Temperatures down to -40 °C

SIRIUS 3SE5 Mechanical Position Switches, Shock & Vibration Railway Standard

3SE5, metal enclosures, enclosure width 31 mm according to EN 50047

Modular system

2 or 3 contacts · Degree of protection IP66/IP67 · Cable entry M20 × 1.5, with increased corrosion protection

Version	Contacts	LEDs	SD	Modular system	Price per PU	PU (UNIT, SET, M)	PS*
			d	Article No.			

Basic switches • Enclosure width 31 mm (with rounded plunger¹⁾)



With plunger

Snap-action contacts	1 NO + 1 NC --	⊕	5	3SE5212-0CC05-1AJ0		1	1 unit
Slow-action contacts	1 NO + 2 NC --	⊕	5	3SE5212-0KC05-1AJ0		1	1 unit
Snap-action contacts	1 NO + 2 NC --	⊕	5	3SE5212-0LC05-1AJ0		1	1 unit

3SE5212-0CC05-1AJ0

⊕ Positive opening according to IEC 60947-5-1, Appendix K, or positively driven actuator, necessary in safety circuits.

¹⁾ For enclosures with widths of 31 mm, the basic switch is a complete unit with rounded plungers.

Note:

For the selection aid, see page 13/13

Version	Diameter	SD	Modular system	Price per PU	PU (UNIT, SET, M)	PS*
	mm	d	Article No.			

Operating mechanisms

Roller plungers, type C, acc. to EN 50047



Plastic roller	10	⊕	5	3SE5000-0AD03-1AJ0		1	1 unit
----------------	----	---	---	--------------------	--	---	--------

3SE5000-0AD03-1AJ0

Roller levers, type E, acc. to EN 50047



Metal lever, plastic roller	13	⊕	5	3SE5000-0AE10-1AJ0		1	1 unit
High-grade steel lever, plastic roller	13	⊕	5	3SE5000-0AE12-1AJ0		1	1 unit
High-grade steel lever, high-grade steel roller	13	⊕	5	3SE5000-0AE13-1AJ0		1	1 unit

3SE5000-0AE10-1AJ0

Angular roller levers



Metal lever, plastic roller	13	⊕	5	3SE5000-0AF10-1AJ0		1	1 unit
High-grade steel lever, plastic roller	13	⊕	5	3SE5000-0AF12-1AJ0		1	1 unit

3SE5000-0AF10-1AJ0

Twist actuators

Twist actuators, for 31 mm/50 mm, EN 50047



Switching right and/or left, adjustable		⊕	5	3SE5000-0AK00-1AJ0		1	1 unit
---	--	---	---	--------------------	--	---	--------

3SE5000-0AK00-1AJ0

Levers

Twist levers straight, 21 mm, type A acc. to EN 50047



Metal lever, plastic roller	19	⊕	5	3SE5000-0AA21-1AJ0		1	1 unit
High-grade steel lever, plastic roller	19	⊕	5	3SE5000-0AA31-1AJ0		1	1 unit

3SE5000-0AA21-1AJ0

Twist levers, adjustable length, with grid hole



Metal lever, plastic roller	19	⊕	5	3SE5000-0AA60-1AJ0		1	1 unit
High-grade steel lever, plastic roller	19	⊕	5	3SE5000-0AA62-1AJ0		1	1 unit

3SE5000-0AA60-1AJ0

⊕ Positively driven actuator, necessary in safety circuits.

SIRIUS 3SE5 Mechanical Position Switches for Ambient Temperatures down to -40 °C

SIRIUS 3SE5 Mechanical Position Switches, Shock & Vibration Railway Standard

3SE5, metal enclosures, enclosure width 40 mm according to EN 50041 / 56 mm, XL





Selection and ordering data

Complete units



2 or 3 contacts · Degree of protection IP66/IP67 · Cable entry M20 x 1.5, with increased corrosion protection

Version	Contacts	SD	Complete units	PU (UNIT, SET, M)	PS*
			Article No.	Price per PU	

Complete units • Enclosure width 40 mm

	Rounded plungers, type B, acc. to EN 50041 With high-grade steel plungers, with 3 mm overtravel Snap-action contacts	1 NO + 1 NC	⊕ 5	3SE5112-0CC02-1AJ0	1	1 unit
3SE5112-0CC02-1AJ0						
	Roller plungers, type C, acc. to EN 50041 With high-grade steel plungers, with 3 mm overtravel Snap-action contacts	1 NO + 2 NC	⊕ 5	3SE5112-0LD02-1AJ0	1	1 unit
3SE5112-0LD02-1AJ0						
	Twist levers, type A, acc. to EN 50041 With high-grade steel lever 27 mm and plastic roller 19 mm Snap-action contacts	1 NO + 2 NC	⊕ 5	3SE5112-0LH11-1AJ0	1	1 unit
3SE5112-0LH11-1AJ0						
	With high-grade steel lever 27 mm and high-grade steel roller 19 mm Snap-action contacts	2 x (1 NO + 1 NC) NEW	⊕ 10	3SE5162-0CH12-1AN5	1	1 unit
3SE5112-0LH11-1AJ0						
	Twist levers, adjustable length With high-grade steel lever with grid hole and plastic roller 19 mm Snap-action contacts	1 NO + 1 NC	⊕ 5	3SE5112-0CH62-1AJ0	1	1 unit
3SE5112-0CH62-1AJ0						

Complete units • Enclosure width 56 mm, XL, 3 x M20 x 1.5

	Twist levers, adjustable length With metal lever with grid hole and plastic roller 19 mm Snap-action contacts	1 NO + 1 NC	⊕ 5	3SE5162-0CH60-1AJ0	1	1 unit
3SE5162-0CH60-1AJ0						
	With high-grade steel lever and high-grade steel roller 19 mm Snap-action contacts	2 x (1 NO + 1 NC) NEW	⊕ 10	3SE5162-0CH63-1AN6	1	1 unit
3SE5162-0CH60-1AJ0						

⊕ Positive opening according to IEC 60947-5-1, Appendix K or positively driven actuator, necessary in safety circuits.

Note:

If the device you require is not available as a complete unit, see [Modular system, page 13/81](#).

SIRIUS 3SE5 Mechanical Position Switches for Ambient Temperatures down to -40 °C

SIRIUS 3SE5 Mechanical Position Switches, Shock & Vibration Railway Standard

3SE5, metal enclosures, enclosure width 40 mm according to EN 50041 / 56 mm / 56 mm, XL

Selection and ordering data

Modular system

2, 3 or 4 contacts · Degree of protection IP66/IP67 · Cable entry M20 × 1.5, with increased corrosion protection

Version	Contacts	LEDs	SD	Modular system	PU (UNIT, SET, M)	PS*
			d	Article No.	Price per PU	

Basic switches • Enclosure width 40 mm



With connecting thread M20 × 1.5

Snap-action contacts	1 NO + 1 NC	--	⊕ 5	3SE5112-0CA00-1AJ0	1	1 unit
Slow-action contacts	1 NO + 2 NC	--	⊕ 5	3SE5112-0KA00-1AJ0	1	1 unit
Snap-action contacts	1 NO + 2 NC	--	⊕ 5	3SE5112-0LA00-1AJ0	1	1 unit

3SE5112-0CA00-1AJ0

Basic switches • Enclosure width 56 mm



With 3 x connecting thread M20 × 1.5

Snap-action contacts	1 NO + 1 NC	--	⊕ 5	3SE5122-0CA00-1AJ0	1	1 unit
Slow-action contacts	1 NO + 2 NC	--	⊕ 5	3SE5122-0KA00-1AJ0	1	1 unit
Snap-action contacts	1 NO + 2 NC	--	⊕ 5	3SE5122-0LA00-1AJ0	1	1 unit

3SE5122-0CA00-1AJ0

Basic switches • Enclosure width 56 mm, XL



With 3 x connection thread M20 × 1.5

Slow-action contacts	2 × (1 NO + 1 NC)	--	⊕ 5	3SE5162-0BA00-1AJ0	1	1 unit
Snap-action contacts	2 × (1 NO + 1 NC)	--	⊕ 5	3SE5162-0CA00-1AJ0	1	1 unit

3SE5162-0BA00-1AJ0

⊕ Positive opening according to IEC 60947-5-1, Appendix K or positively driven actuator, necessary in safety circuits.







Note:

For the selection aid, see page 13/13

SIRIUS 3SE5 Mechanical Position Switches for Ambient Temperatures down to -40 °C

SIRIUS 3SE5 Mechanical Position Switches, Shock & Vibration Railway Standard

3SE5, metal enclosures, enclosure width 40 mm according to EN 50041 / 56 mm / 56 mm, XL

Version	Diameter	SD	Modular system	PU (UNIT, SET, M)	PS*
	mm	d	Article No.	Price per PU	
Operating mechanisms					
	Rounded plungers, type B, acc. to EN 50041				
	High-grade steel plunger, with 3 mm overtravel	10	⊕ 5	3SE5000-0AC02-1AJ0	1 1 unit
3SE5000-0AC02-1AJ0					
	Roller plungers, type C, acc. to EN 50041				
	High-grade steel roller, with 3 mm overtravel	10	⊕ 5	3SE5000-0AD02-1AJ0	1 1 unit
3SE5000-0AD02-1AJ0					
	Roller levers				
	Metal lever, plastic roller	13	⊕ 5	3SE5000-0AE01-1AJ0	1 1 unit
	High-grade steel lever, plastic roller	13	⊕ 5	3SE5000-0AE03-1AJ0	1 1 unit
3SE5000-0AE01-1AJ0					
	Angular roller levers				
	Metal lever, plastic roller	13	⊕ 5	3SE5000-0AF01-1AJ0	1 1 unit
	High-grade steel lever, plastic roller	13	⊕ 5	3SE5000-0AF03-1AJ0	1 1 unit
3SE5000-0AF01-1AJ0					
Twist actuators					
	Twist actuators, for 40/56/56 XL mm EN 50041				
	Switching right and/or left, adjustable		⊕ 5	3SE5000-0AH00-1AJ0	1 1 unit
3SE5000-0AH00-1AJ0					
	Levers				
	Twist levers, type A, acc. to EN 50041				
	Metal lever, plastic roller	19	⊕ 5	3SE5000-0AA01-1AJ0	1 1 unit
	High-grade steel lever, plastic roller	19	⊕ 5	3SE5000-0AA11-1AJ0	1 1 unit
3SE5000-0AA01-1AJ0					
	Twist levers, adjustable length, with grid hole				
	Metal lever, plastic roller	19	⊕ 5	3SE5000-0AA60-1AJ0	1 1 unit
	High-grade steel lever, plastic roller	19	⊕ 5	3SE5000-0AA62-1AJ0	1 1 unit
3SE5000-0AA60-1AJ0					

⊕ Positively driven actuator, necessary in safety circuits.

SIRIUS 3SE5 Mechanical Position Switches for Ambient Temperatures down to -40 °C

SIRIUS 3SE5 Mechanical Safety Switches, Separate Actuator, Shock & Vibration Railway Std

3SE5, plastic enclosures, enclosure width 31 mm according to EN 50047

Selection and ordering data

Complete units

2 or 3 contacts · 5 directions of approach · Degree of protection IP65 (31 mm) or IP66/IP67 (50 mm) · Cable entry M20 × 1.5

Version	Contacts	LEDs	SD	Complete units	PU (UNIT, SET, M)	PS*
			d	Article No.	Price per PU	

Enclosure width 31 mm according to EN 50047



3SE5232-0RV40-1AJ0

Ambient temperature down to -40° C
With increased corrosion protection

Slow-action contacts 1 NO + 1 NC -- ↻ 5 **3SE5232-0RV40-1AJ0** 1 1 unit

Accessories/spare parts

Version	SD	Article No.	Price per PU	PU (UNIT, SET, M)	PS*
	d				

Accessories



3SE5000-0AW11

Standard actuator

- With transverse fixing, plastic, length 40 mm

5 **3SE5000-0AW11** 1 1 unit



3SE5000-0AW51

High-grade steel actuator¹⁾

- Length 75.6 mm

5 **3SE5000-0AW51** 1 1 unit



3SE5000-0AW52

- With vertical fixing, length 53 mm

5 **3SE5000-0AW52** 1 1 unit



3SE5000-0AW53

- With transverse fixing, length 47 mm

5 **3SE5000-0AW53** 1 1 unit

¹⁾ With optimized geometry and suitable for extreme environmental conditions such as -40 °C

SIRIUS 3SE5 Mechanical Position Switches for Ambient Temperatures down to -40 °C

SIRIUS 3SE5 Mechanical Safety Switches with Tumbler, Shock & Vibration Railway Std

3SE5, plastic enclosures

Selection and ordering data

6 slow-action contacts · 5 directions of approach · Degree of protection IP66/IP67 · Cable entry 3 × M20 × 1.5 · Locking force 1 300 N

Tumbler ¹⁾	Solenoid, rated operational voltage	SD	Complete units Position monitoring: Actuators: 1 NO + 2 NC Solenoid: 1 NO + 2 NC	<input type="checkbox"/>	PU (UNIT, SET, M)	PS*
	V	d	Article No.	Price per PU		

1 300 N locking force • Enclosure width 54 mm



Spring-actuated locks

- With escape release from the front and emergency release from the back
- With auxiliary release

24 DC



5

NEW

5

3SE5322-0SL21-1AJ0

1 1 unit

3SE5322-0SD21-1AJ0

1 1 unit

3SE5322-0SL21-1AJ0

☞ Positive opening according to IEC 60947-5-1, Appendix K.

¹⁾ Supplied without actuator. Please order separately.

Accessories/spare parts

Version	SD	Article No.	Price per PU	PU (UNIT, SET, M)	PS*
	d				

Accessories



Standard actuator

- Length 75.6 mm

3SE5000-0AV01

▶

3SE5000-0AV01

1 1 unit



High-grade steel actuator¹⁾

- Length 75.6 mm

3SE5000-0AW51

5

3SE5000-0AW51

1 1 unit



- With vertical fixing, length 53 mm

3SE5000-0AW52

NEW

5

3SE5000-0AW52

1 1 unit



- With transverse fixing, length 47 mm

3SE5000-0AW53

5

3SE5000-0AW53

1 1 unit

¹⁾ With optimized geometry and suitable for extreme environmental conditions such as -40 °C

General data

Overview

The 3SF1 position switches with safety-related communication can be directly connected using the AS-Interface bus system. The safety functions no longer have to be wired up conventionally.

With the 3SF1 position switches the ASIsafe electronics are integrated in the switch enclosure.



Examples of selection options in the modular system

Modular system

The position switches of the 3SF11.4 and 3SF12.4 series are designed as a modular system comprising different versions of the basic switch and an actuator which must be ordered separately. Thanks to the modular design of the switch the end users can select the right solution for their application from numerous versions and install it themselves in a very short time.

Design

The 3SF1 switches are available in four different enclosure sizes:

- Plastic and metal enclosures according to EN 50047, 31 mm wide, with M12 device plug
- Metal enclosures according to EN 50041, 40 mm wide, with M12 device plug
- Plastic enclosures, 50 mm wide, with M12 device plug and M12 socket
- Metal enclosures, 56 mm wide, with M12 device plug and M12 socket

Display

The switches have a status display with three LEDs:

- LED 1 (yellow): F-IN1
- LED 2 (yellow): F-IN2
- LED 3 (green/red): AS-i/FAULT

Connection

Connection to the AS-Interface is by means of a 4-pole M12 device plug (plastic version) connected to the yellow AS-Interface bus cable.

The wide enclosures (50 or 56 mm) also have an M12 socket for connecting a second position switch. Category 4 according to EN ISO 13849-1 is thus achieved.

Benefits

The new generation of 3SF1 position switches offers:

- ASIsafe electronics integrated in the enclosure, with low power consumption < 60 mA
- An extensive range of actuators
- Status display with three LEDs
- Can be integrated easily via TIA Portal

Application

With the standard position switches, mechanical positions of moving machine parts are converted into electrical signals. Through their modular and uniform design and large number of variants, the devices can comply with practically all requirements in industry.

Devices are available with enclosure versions to suit the particular ambient conditions. Different control tasks can be performed with the contact blocks best suited for the particular purpose. And many different actuator variants are available to match the mechanical configuration of the moving machine parts. Dimensions, fixing points and characteristics are largely in accordance with the EN 50041 or EN 50047 standards.

The devices are suitable for use in any climate.

Standards

The switches comply with the standards IEC 60947-1 (Low-Voltage Controlgear, General) and IEC 60947-5-1 (Electromechanical Control Devices).

The mechanical design of the switch corresponds to the requirements of the fail-safe principle according to EN ISO 14119.

Approvals

AS-Interface according to EN 50295 and IEC 62026-2.

With a 3SF1 position switch it is possible to achieve Category 2 according to EN ISO 13849-1 or SIL 1 according to IEC 61508.

Categories 3 or 4 according to EN ISO 13849-1 or SIL 2 or 3 according to IEC 61508 can be achieved by using a second 3SE5 position switch.

The 3SF1 position switches are approved according to UL 508, UL 50 and UL 746-C.

General data

Technical specifications

Type	3SF11..., 3SF12..	
General data		
Standards	IEC/EN 60947-5-1, EN ISO 14119	
According to AS-Interface specification		
• I/O configuration/ID configuration	0/B	
• ID1 code/ID2 code (Hex)	F/F	
• Power consumption, overall	mA	≤ 60
Inputs		
• Low signal range	Contact open	
• High signal range	Contact closed, I_{in} dynamic ($I_{peak} \geq 5$ mA)	
Status display	Green/red dual LED	
Rated impulse withstand voltage U_{imp}	kV	0.6
EMC strength		
• IEC 61000-1-2	kV	4
• IEC 61000-4-3	V/m	10
• IEC 61000-4-4 (A/B)	kV	1/2
Mechanical endurance		
• Basic switch	15 × 10 ⁶ operating cycles	
• With separate actuator, 3SF1...-..V..	1 × 10 ⁶ operating cycles	
PFH value		
Probability of failure upon request of the safety function, with 1 actuation per hour and $B10 = 5 \times 10^6$		
• Basic switch	1/h	4 × 10 ⁻⁹
• With separate actuator, 3SF1...-..V..	1/h	2 × 10 ⁻⁹
• Hinge switches, 3SF1...-..U..	1/h	2 × 10 ⁻⁹
Shock resistance acc. to IEC 60068-2-27	30 g / 11 ms	

Type	3SF1234	3SF1134	3SF1244	3SF1214	3SF1114	3SF1124	
Enclosure							
Enclosure	Ultramid A3X2G7			Zinc die casting GD Zn Al4 Cu1			
• Material	Ultramid A3X2G7			Zinc die casting GD Zn Al4 Cu1			
• Width	mm	31	40	50	31	40	56
• Dimensions according to EN		EN 50047	EN 50041	--	EN 50047	EN 50041	--
Degree of protection acc. to IEC 60529		IP65	IP66/IP67				
Ambient temperature							
• During operation	°C	-25 ... +60					
• Storage, transport	°C	-40 ... +80					
Mounting position	Any						

Pin assignment

M12 device plug, 4-pole



- 1 ASI +
- 2 Not assigned
- 3 ASI -
- 4 Not assigned

M12 socket, 4-pole

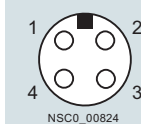

- 1 Channel 2
- 2 Channel 2
- 3 Not assigned
- 4 Not assigned

LEDs

Status display (operating state)

LED	No voltage on AS-Interface chip	Communication OK	Communication failed	Slave has address "0"
ASI/Fault (GN/RD)				

Safe inputs

LED	Not actuated	Actuated		
F-IN1 (YE)				
F-IN2 (YE)				

SIRIUS 3SF1 Mechanical Safety Switches for AS-Interface

3SF1, plastic enclosures, enclosure width 31 mm according to EN 50047 / 50 mm

Selection and ordering data

Modular system

For the ASIsafe version of the position switch, the basic switch and actuator must be ordered separately.

1 or 2 contacts · 3 LEDs · Degree of protection IP65 (31 mm) or IP66/IP67 (50 mm) · M12 device plug

Version	Contacts	LEDs	SD	Modular system		PU (UNIT, SET, M)	PS*
			d	Article No.	Price per PU		

Basic switches (with rounded plunger¹⁾) • Enclosure width 31 mm acc. to EN 50047



With teflon plunger

With M12 device plug, 4-pole, channel 1 on NC contact, channel 2 on NC contact

Slow-action contacts	2 NC	24 V DC		5
Snap-action contacts	2 NC	24 V DC		5

3SF1234-1KC05-1BA1
3SF1234-1LC05-1BA1

1 1 unit
1 1 unit

3SF1234-1KC05-1BA1

Basic switches (with rounded plunger¹⁾) • Enclosure width 50 mm



With teflon plunger

With M12 device plug, 4-pole, channel 1 on NC contact, channel 2 on M12 socket, right

Slow-action contacts	1 NC	24 V DC		5
Snap-action contacts	1 NC	24 V DC		5

3SF1244-1KC05-1BA2
3SF1244-1LC05-1BA2

1 1 unit
1 1 unit

3SF1244-1KC05-1BA2

Positive opening according to IEC 60947-5-1, Appendix K, or positively driven actuator, for use in safety circuits.







¹⁾ For enclosures with widths of 31 mm and 50 mm, the basic switch is a complete unit with rounded plungers.

Note:

For the selection aid, see page 13/13

SIRIUS 3SF1 Mechanical Safety Switches for AS-Interface

3SF1, plastic enclosures, enclosure width 31 mm according to EN 50047 / 50 mm

Version	Roller diameter	SD	Modular system	PU (UNIT, SET, M)	PS*
	mm	d	Article No.	Price per PU	
Operating mechanisms					
	Roller plungers, type C, acc. to EN 50047				
	Plastic roller	10	⊕ 2	3SE5000-0AD03	1 1 unit
	High-grade steel roller	10	⊕ 5	3SE5000-0AD04	1 1 unit
3SE5000-0AD03					
	Roller plungers with central fixing				
	Plastic roller	10	⊕ 2	3SE5000-0AD10	1 1 unit
	High-grade steel roller	10	⊕ 5	3SE5000-0AD11	1 1 unit
3SE5000-0AD10					
	Roller levers, type E, acc. to EN 50047				
	Metal lever, plastic roller	13	⊕ 2	3SE5000-0AE10	1 1 unit
	Metal lever, high-grade steel roller	13	⊕ 5	3SE5000-0AE11	1 1 unit
	High-grade steel lever, plastic roller	13	⊕ 5	3SE5000-0AE12	1 1 unit
3SE5000-0AE10	High-grade steel lever, high-grade steel roller	13	⊕ 5	3SE5000-0AE13	1 1 unit
	Angular roller levers				
	Metal lever, plastic roller	13	⊕ 2	3SE5000-0AF10	1 1 unit
	Metal lever, high-grade steel roller	13	⊕ 5	3SE5000-0AF11	1 1 unit
	High-grade steel lever, plastic roller	13	⊕ 2	3SE5000-0AF12	1 1 unit
3SE5000-0AF10	High-grade steel lever, high-grade steel roller	13	⊕ 5	3SE5000-0AF13	1 1 unit
Twist actuators with lever					
	Twist actuators, for 31 mm/50 mm, EN 50047				
	Switching right or left, adjustable		⊕ 2	3SE5000-0AK00	1 1 unit
3SE5000-0AK00					
	Levers				
	Twist levers, type A, acc. to EN 50047				
	Metal lever, plastic roller	19	⊕ 2	3SE5000-0AA21	1 1 unit
	Metal lever, high-grade steel roller	19	⊕ 5	3SE5000-0AA22	1 1 unit
	Metal lever, high-grade steel roller with ball bearing	19	⊕ 5	3SE5000-0AA23	1 1 unit
	Metal lever, plastic roller	30	⊕ 5	3SE5000-0AA25	1 1 unit
	High-grade steel lever, plastic roller	19	⊕ 5	3SE5000-0AA31	1 1 unit
	High-grade steel lever, high-grade steel roller	19	⊕ 5	3SE5000-0AA32	1 1 unit
	Twist levers 30 mm, straight¹⁾				
	Metal lever, plastic roller	19	⊕ 5	3SE5000-0AA24	1 1 unit
Metal lever, plastic roller	30	⊕ 5	3SE5000-0AA26	1 1 unit	
	Twist levers, adjustable length, with grid hole				
	Metal lever, plastic roller	19	⊕ 5	3SE5000-0AA60	1 1 unit
	Metal lever, high-grade steel roller	19	⊕ 5	3SE5000-0AA61	1 1 unit
	Metal lever, plastic roller	50	⊕ 5	3SE5000-0AA67	1 1 unit
	Metal lever, rubber roller	50	⊕ 5	3SE5000-0AA68	1 1 unit
	High-grade steel lever, plastic roller	19	⊕ 5	3SE5000-0AA62	1 1 unit
3SE5000-0AA60	High-grade steel lever, high-grade steel roller	19	⊕ 5	3SE5000-0AA63	1 1 unit

⊕ Positively driven actuator, for use in safety circuits.

¹⁾ Can be clinch mounted (turned through 180°, rear of lever).

Selection and ordering data

Modular system

For the ASIsafe version of the position switch, the basic switch and actuator must be ordered separately.

2 contacts · 3 LEDs · Degree of protection IP66/IP67 · M12 device plug

Version	Contacts	LEDs	SD	Modular system	<input type="checkbox"/>	PU (UNIT, SET, M)	PS*
			d	Article No.	Price per PU		

Basic switches (with rounded plunger¹⁾) • Enclosure width 31 mm acc. to EN 50047



With plunger

With M12 device plug, 4-pole, channel 1 on NC contact, channel 2 on NC contact

Slow-action contacts	2 NC	24 V DC	⊕	5	3SF1214-1KC05-1BA1 3SF1214-1LC05-1BA1	1	1 unit
Snap-action contacts	2 NC	24 V DC	⊕	5		1	1 unit

3SF1214-1KC05-1BA1

⊕ Positive opening according to IEC 60947-5-1, Appendix K, or positively driven actuator, for use in safety circuits.









¹⁾ For enclosures with widths of 31 mm, the basic switch is a complete unit with rounded plungers.

Note:

For the selection aid, see page 13/13

SIRIUS 3SF1 Mechanical Safety Switches for AS-Interface

3SF1, metal enclosures, enclosure width 31 mm according to EN 5047

Version	Roller diameter	SD	Modular system	PU (UNIT, SET, M)	PS*
	mm	d	Article No.	Price per PU	
Operating mechanisms					
	Plain plungers				
3SE5000-0AB01	High-grade steel plunger	10	⊕ 2	3SE5000-0AB01	1 1 unit
Roller plungers, type C, acc. to EN 5047					
	Plastic roller	10	⊕ 2	3SE5000-0AD03	1 1 unit
3SE5000-0AD03	High-grade steel roller	10	⊕ 5	3SE5000-0AD04	1 1 unit
Roller plungers with central fixing					
	Plastic roller	10	⊕ 2	3SE5000-0AD10	1 1 unit
3SE5000-0AD10	High-grade steel roller	10	⊕ 5	3SE5000-0AD11	1 1 unit
Roller levers, type E, acc. to EN 5047					
	Metal lever, plastic roller	13	⊕ 2	3SE5000-0AE10	1 1 unit
3SE5000-0AE10	Metal lever, high-grade steel roller	13	⊕ 5	3SE5000-0AE11	1 1 unit
	High-grade steel lever, plastic roller	13	⊕ 5	3SE5000-0AE12	1 1 unit
	High-grade steel lever, high-grade steel roller	13	⊕ 5	3SE5000-0AE13	1 1 unit
Angular roller levers					
	Metal lever, plastic roller	13	⊕ 2	3SE5000-0AF10	1 1 unit
3SE5000-0AF10	Metal lever, high-grade steel roller	13	⊕ 5	3SE5000-0AF11	1 1 unit
	High-grade steel lever, plastic roller	13	⊕ 2	3SE5000-0AF12	1 1 unit
	High-grade steel lever, high-grade steel roller	13	⊕ 5	3SE5000-0AF13	1 1 unit
Twist actuators with lever					
	Twist actuators, for 31 mm/50 mm, EN 5047				
3SE5000-0AK00	Switching right or left, adjustable		⊕ 2	3SE5000-0AK00	1 1 unit
Levers					
Twist levers, type A, acc. to EN 5047					
	Metal lever, plastic roller	19	⊕ 2	3SE5000-0AA21	1 1 unit
3SE5000-0AA21	Metal lever, high-grade steel roller	19	⊕ 5	3SE5000-0AA22	1 1 unit
	Metal lever, high-grade steel roller with ball bearing	19	⊕ 5	3SE5000-0AA23	1 1 unit
	Metal lever, plastic roller	30	⊕ 5	3SE5000-0AA25	1 1 unit
	High-grade steel lever, plastic roller	19	⊕ 5	3SE5000-0AA31	1 1 unit
	High-grade steel lever, high-grade steel roller	19	⊕ 5	3SE5000-0AA32	1 1 unit
Twist levers 30 mm, straight¹⁾					
	Metal lever, plastic roller	19	⊕ 5	3SE5000-0AA24	1 1 unit
	Metal lever, plastic roller	30	⊕ 5	3SE5000-0AA26	1 1 unit
Twist levers, adjustable length, with grid hole					
	Metal lever, plastic roller	19	⊕ 5	3SE5000-0AA60	1 1 unit
3SE5000-0AA60	Metal lever, high-grade steel roller	19	⊕ 5	3SE5000-0AA61	1 1 unit
	Metal lever, plastic roller	50	⊕ 5	3SE5000-0AA67	1 1 unit
	Metal lever, rubber roller	50	⊕ 5	3SE5000-0AA68	1 1 unit
	High-grade steel lever, plastic roller	19	⊕ 5	3SE5000-0AA62	1 1 unit
	High-grade steel lever, high-grade steel roller	19	⊕ 5	3SE5000-0AA63	1 1 unit

⊕ Positively driven actuator, for use in safety circuits.

¹⁾ Can be clinch mounted (turned through 180°, rear of lever).

Selection and ordering data

Modular system

For the ASIsafe version of the position switch, the basic switch and actuator must be ordered separately.

1 or 2 contacts · 3 LEDs · Degree of protection IP66/IP67 · M12 device plug

Version	Contacts	LEDs	SD	Modular system	PU (UNIT, SET, M)	PS*
			d	Article No.	Price per PU	

Basic switches - Enclosure width 40 mm acc. to EN 50041



With M12 device plug, 4-pole, channel 1 on NC contact, channel 2 on NC contact

Slow-action contacts	2 NC	24 V DC	⊕	5
Snap-action contacts	2 NC	24 V DC	⊕	5

3SF1114-1KA00-1BA1	1	1 unit
3SF1114-1LA00-1BA1	1	1 unit

3SF1114-1KA00-1BA1

Basic switches - Enclosure width 56 mm



With M12 device plug, 4-pole, channel 1 on NC contact, channel 2 on M12 socket, right

Slow-action contacts	1 NC	24 V DC	⊕	5
Snap-action contacts	1 NC	24 V DC	⊕	5

3SF1124-1KA00-1BA2	1	1 unit
3SF1124-1LA00-1BA2	1	1 unit

3SF1124-1KA00-1BA2

⊕ Positively opening according to IEC 60947-5-1, Appendix K, or positively driven actuator, for use in safety circuits.

Note:

For the selection aid, see page 13/13

Version	Roller diameter	SD	Modular system	PU (UNIT, SET, M)	PS*
	mm	d	Article No.	Price per PU	

Operating mechanisms



Plain plungers

High-grade steel plunger	10	⊕	2
--------------------------	----	---	---

3SE5000-0AB01	1	1 unit
----------------------	---	--------

3SE5000-0AB01



Rounded plungers, type B, acc. to EN 50041

High-grade steel plunger, with 3 mm overtravel	10	⊕	5
--	----	---	---

3SE5000-0AC02	1	1 unit
----------------------	---	--------

3SE5000-0AC02



Roller plungers, type C, acc. to EN 50041

High-grade steel roller, with 3 mm overtravel	13	⊕	5
---	----	---	---







3SE5000-0AD02	1	1 unit
----------------------	---	--------

3SE5000-0AD02

⊕ Positively driven actuator, for use in safety circuits.

SIRIUS 3SF1 Mechanical Safety Switches for AS-Interface

3SF1, metal enclosures, enclosure width 40 mm according to EN 50041 / 56 mm

Version	Roller diameter	SD	Modular system	PU (UNIT, SET, M)	PS*	
	mm	d	Article No.	Price per PU		
Operating mechanisms						
 3SE5000-0AE01	Roller levers					
	Metal lever, plastic roller	22	⊕ 2	3SE5000-0AE01	1 1 unit	
	Metal lever, high-grade steel roller	22	⊕ 5	3SE5000-0AE02	1 1 unit	
	High-grade steel lever, plastic roller	22	⊕ 5	3SE5000-0AE03	1 1 unit	
 3SE5000-0AF01	Angular roller levers					
	Metal lever, plastic roller	22	⊕ 2	3SE5000-0AF01	1 1 unit	
	Metal lever, high-grade steel roller	22	⊕ 5	3SE5000-0AF02	1 1 unit	
	High-grade steel lever, plastic roller	22	⊕ 5	3SE5000-0AF03	1 1 unit	
 3SE5000-0AH00	Twist actuators, for 40/56/56 XL mm EN 50041					
	<ul style="list-style-type: none"> For twist levers, switching right or left, adjustable - For enclosure width 40 and 56 mm 		⊕ 2	3SE5000-0AH00	1 1 unit	
	<ul style="list-style-type: none"> For fork levers, latching 		⊕ 5	3SE5000-0AT10	1 1 unit	
	Levers					
 3SE5000-0AA01	Twist levers 27 mm, offset, type A, acc. to EN 50041					
	Metal lever, plastic roller	19	⊕ 2	3SE5000-0AA01	1 1 unit	
	Metal lever, high-grade steel roller	19	⊕ 2	3SE5000-0AA02	1 1 unit	
	Metal lever, high-grade steel roller with ball bearing	19	⊕ 5	3SE5000-0AA03	1 1 unit	
	Metal lever, 2 plastic rollers	19	⊕ 5	3SE5000-0AA04	1 1 unit	
	Metal lever, plastic roller	30	⊕ 5	3SE5000-0AA05	1 1 unit	
	Metal lever, plastic roller	50	⊕ 5	3SE5000-0AA07	1 1 unit	
	Metal lever, rubber roller	50	⊕ 5	3SE5000-0AA08	1 1 unit	
	High-grade steel lever, plastic roller	19	⊕ 5	3SE5000-0AA11	1 1 unit	
	High-grade steel lever, high-grade steel roller	19	⊕ 5	3SE5000-0AA12	1 1 unit	
	Twist levers 35 mm, offset					
	Metal lever, plastic roller	19	⊕ 5	3SE5000-0AA15	1 1 unit	
High-grade steel lever, plastic roller	19	⊕ 5	3SE5000-0AA16	1 1 unit		
Twist levers 30 mm, straight¹⁾						
Metal lever, plastic roller	19	⊕ 5	3SE5000-0AA24	1 1 unit		
Metal lever, plastic roller	30	⊕ 5	3SE5000-0AA26	1 1 unit		
 3SE5000-0AA60	Twist levers, adjustable length, with grid hole					
	Metal lever, plastic roller	19	⊕ 5	3SE5000-0AA60	1 1 unit	
	Metal lever, high-grade steel roller	19	⊕ 5	3SE5000-0AA61	1 1 unit	
	Metal lever, plastic roller	50	⊕ 5	3SE5000-0AA67	1 1 unit	
	Metal lever, rubber roller	50	⊕ 5	3SE5000-0AA68	1 1 unit	
	High-grade steel lever, plastic roller	19	⊕ 5	3SE5000-0AA62	1 1 unit	
 3SE5000-0AT01	Fork levers (for switches with snap-action contacts only)					
	Metal lever, 2 plastic rollers	19	⊕ 5	3SE5000-0AT01	1 1 unit	
	Metal lever, 2 high-grade steel rollers	19	⊕ 5	3SE5000-0AT02	1 1 unit	
	High-grade steel lever, 2 plastic rollers	19	⊕ 5	3SE5000-0AT03	1 1 unit	
High-grade steel lever, 2 high-grade steel rollers	19	⊕ 5	3SE5000-0AT04	1 1 unit		

⊕ Positively driven actuator, for use in safety circuits.

¹⁾ Can be clinch mounted (turned through 180°, rear of lever).

With Separate Actuator

General data

Overview

The 3SF1 safety switches with safety-related communication can be directly connected using the AS-Interface bus system. The safety functions no longer have to be wired up conventionally.

With the 3SF1 safety switches the ASIsafe electronics are integrated in the switch enclosure.



3SF1 safety switches with head for separate actuator and with integrated ASIsafe electronics

3SF1 safety switches with separate actuator have the same enclosures as the 3SF1 position switches.

Operation

The actuator head is included in the scope of supply. For actuation from four directions it can be adjusted through $4 \times 90^\circ$. The switches can also be approached from above.

The actuators are not included in the scope of supply of the safety switch and must be ordered separately from a choice of different versions to suit the application, (see page 13/96).

The actuator is encoded. Simple overruling by hand or auxiliary devices is impossible.

A high-grade steel blocking insert for attaching up to eight padlocks is available for even more safety.

A rubber cap to protect the actuator head from contamination is available for operation in dusty environments.

Display

The switches have a status display with three LEDs:

- LED 1 (yellow): F-IN1
- LED 2 (yellow): F-IN2
- LED 3 (green/red): AS-i/FAULT

Connection

Connection to the AS-Interface is by means of a 4-pole M12 device plug (plastic version) connected to the yellow AS-Interface bus cable.

The wide enclosures (50 or 56 mm) also have an M12 socket for connecting a second safety switch. Category 4 according to EN ISO 13849-1 is thus achieved.

Benefits

The new generation of 3SF1 safety switches with separate actuator offers

- ASIsafe electronics integrated in the enclosure, with low power consumption $< 60 \text{ mA}$
- An extensive range of actuators
- Status display with three LEDs

Application

Safety switches with separate actuator are used where the position of doors, covers or protective grilles must be monitored for safety reasons.

The safety switch can only be operated with the matching coded actuator. Simple overruling by hand or auxiliary devices is impossible.

Devices are available with enclosure versions to suit the particular ambient conditions. Different control tasks can be performed with the contact blocks best suited for the particular purpose. Dimensions and fixing points of the enclosure are in accordance with EN 50041 or EN 50047 standards.

The devices are suitable for use in any climate.

Standards

The switches comply with the standards IEC 60947-1 (Low-Voltage Controlgear, General) and IEC 60947-5-1 (Electromechanical Control Devices).

The mechanical design of the switch corresponds to the requirements of the fail-safe principle according to EN ISO 14119.

Approvals

AS-Interface according to EN 50295 and IEC 62026-2.

With a 3SF1 safety switch it is possible to achieve Category 3 according to EN ISO 13849-1 or SIL 2 according to IEC 61508.

Category 4 according to EN ISO 13849-1 or SIL 3 according to IEC 61508 can be achieved by using an additional 3SE5 safety switch.

The 3SF1 safety switches are approved according to UL 508, UL 50 and UL 746-C.

SIRIUS 3SF1 Mechanical Safety Switches for AS-Interface

With Separate Actuator

3SF1, plastic enclosures, enclosure width 31 mm according to EN 50047 / 50 mm

Overview

- Contacts: 1 or 2 slow-action contacts
- Status display with 3 LEDs 24 V DC;
1: F-IN1, 2: F-IN2, 3: AS-i/FAULT
- Degree of protection IP65 (31 mm) or IP66/IP67 (50 mm)

Selection and ordering data

Version ¹⁾	Contacts	SD	Complete units	PU (UNIT, SET, M)	PS*
		d	Article No.	Price per PU	

Enclosure width 31 mm according to EN 50047



5 directions of approach

With M12 device plug, 4-pole, channel 1 on NC contact, channel 2 on NC contact

Slow-action contacts

2 NC

⌚ 5

3SF1234-1QV40-1BA1

1 1 unit

3SF1234-1QV40-1BA1

Enclosure width 50 mm



5 directions of approach

With M12 device plug, 4-pole, channel 1 on NC contact, channel 2 on M12 socket, right

Slow-action contacts

1 NC

⌚ 5

3SF1244-1QV40-1BA2

1 1 unit

3SF1244-1QV40-1BA2

⌚ Positive opening according to IEC 60947-5-1, Appendix K.

¹⁾ Supplied without actuator. Please order separately (see page 13/96).

SIRIUS 3SF1 Mechanical Safety Switches for AS-Interface



With Separate Actuator

3SF1, metal enclosures, enclosure width 31 mm according to EN 50047 / 40 mm according to EN 50041 / 56 mm

Overview

- Contacts: 1 or 2 slow-action contacts
- Status display with 3 LEDs 24 V DC;
1: F-IN1, 2: F-IN2, 3: AS-i/FAULT
- Degree of protection IP66/IP67

Selection and ordering data

Version ¹⁾	Contacts	SD	Complete units	PU (UNIT, SET, M)	PS*
		d	Article No.	Price per PU	
Enclosure width 31 mm acc. to EN 50047					
	5 directions of approach With M12 device plug, 4-pole, channel 1 on NC contact, channel 2 on NC contact Slow-action contacts	2 NC	⊕ 5	3SF1214-1QV40-1BA1	1 1 unit
3SF1214-1QV40-1BA1					
Enclosure width 40 mm acc. to EN 50041					
	5 directions of approach With M12 device plug, 4-pole, channel 1 on NC contact, channel 2 on NC contact Slow-action contacts	2 NC	⊕ 5	3SF1114-1QV10-1BA1	1 1 unit
3SF1114-1QV10-1BA1					
Enclosure width 56 mm					
	5 directions of approach With M12 device plug, 4-pole, channel 1 on NC contact, channel 2 on M12 socket, right Slow-action contacts	1 NC	⊕ 5	3SF1124-1QV10-1BA2	1 1 unit
3SF1124-1QV10-1BA2					

⊕ Positive opening according to IEC 60947-5-1, Appendix K.

¹⁾ Supplied without actuator. Please order separately (see page 13/96).

SIRIUS 3SF1 Mechanical Safety Switches for AS-Interface

With Separate Actuator

Accessories

Selection and ordering data

Version	SD	Article No.	Price per PU	PU (UNIT, SET, M)	PS*
Actuators					
 3SE5000-0AV01		Standard actuator • Length 75.6 mm		1	1 unit
 3SE5000-0AV02	5	• With vertical fixing, length 53 mm		1	1 unit
 3SE5000-0AV03	5	• With transverse fixing, length 47 mm		1	1 unit
 3SE5000-0AW11	5	• With transverse fixing, plastic ¹⁾ , length 40 mm		1	1 unit
Radius actuators					
 3SE5000-0AV04	2	• Length 51 mm, direction of approach from the left		1	1 unit
 3SE5000-0AV06	5	• Length 51 mm, direction of approach from the right		1	1 unit
Universal radius actuator					
 3SE5000-0AV05-1AA6	5	• Length 77 mm		1	1 unit
	5	• Length 77 mm, tab rotated 90°		1	1 unit
Universal radius actuator, heavy duty					
 3SE5000-0AV07	2	• Length 67 mm		1	1 unit
	5	• Length 77 mm		1	1 unit
Optional accessories					
 3SE5000-0AV08-1AA2	5	Protective caps , black rubber For the actuator head, to protect the actuator openings from contamination (Only for enclosure width 40 mm or 56 mm)		1	1 unit
 3SE5000-0AV08-1AA3	5	Blocking inserts , high-grade steel, for actuator head For up to eight padlocks		1	1 unit

¹⁾ Not suitable for safety switches with tumbler.

Overview

The 3SF1 safety switches with safety-related communication can be directly connected using the AS-Interface bus system. The safety functions no longer have to be wired up conventionally.

With the 3SF1 safety switches the ASIsafe electronics are integrated in the switch enclosure.



3SF1 safety switch with tumbler and with integrated ASIsafe electronics

Operation

The actuator head is included in the scope of supply. For actuation from four directions it can be adjusted through $4 \times 90^\circ$. The switches can also be approached from above.

The actuators are not included in the scope of supply of the safety switch and must be ordered separately from a choice of different versions to suit the application, (see page 13/96).

The actuator is encoded. Simple overruling by hand or auxiliary devices is impossible.

A high-grade steel blocking insert for attaching up to eight padlocks is available for even more safety.

A rubber cap to protect the actuator entry of the actuator head from contamination is available for operation of the enclosures in dusty environments.

Tumbler

There are two versions for interlocking the actuator:

- Spring-actuated lock (closed-circuit principle) with various release mechanisms
- Solenoid-locked (open-circuit principle)

For more explanations, (see page 13/59).

Display

The switches have a status display with four LEDs:

- LED 1 (green): AS-i
- LED 2 (red): FAULT
- LED 3 (yellow): F-IN1
- LED 4 (yellow): F-IN2

Connection

Connection to the AS-Interface is by means of a 4-pole M12 device plug (plastic version) connected to the yellow AS-Interface bus cable (no additional supply of auxiliary power is required thanks to the low current consumption of the solenoid of max. 170 mA).

Benefits

The new generation of 3SF13 safety switches with tumbler offers:

- More safety through higher locking forces:
 - 1 300 N for the plastic version
 - 2 600 N for the metal version
- Various release mechanisms: lock release, escape release and emergency release
- ASIsafe electronics integrated in the enclosure; connected through 4-pole M12 device plug
- Current consumption of the solenoid no more than 170 mA
- Two contact blocks as standard equipment, hence fewer versions needed
- Same dimensions for all enclosure versions: plastic, metal
- An extensive range of actuators
- Status display with four LEDs
- 3SF1324-1S.21-1BK4 series with high degree of protection IP69K, IP69 in accordance with IEC 60529, cover with foamed seal

Application

The safety switches with tumbler are exceptional safety-related devices which prevent an unforeseen or intentional opening of protective doors, protective grilles or other covers as long as a dangerous situation is present (i.e. follow-on motion of the switched-off machine).

The safety switches with tumbler have the following functions:

- Enabling the machine or process with closed and locked protective device
- Locking the machine or process with opened protective device
- Position monitoring of the protective device and tumbler

Standards

The switches comply with the standards IEC 60947-1 (Low-Voltage Controlgear, General) and IEC 60947-5-1 (Electromechanical Control Devices).

The mechanical design of the switch corresponds to the requirements of the fail-safe principle according to EN ISO 14119.

Approvals

AS-Interface according to EN 50295 and IEC 62026-2

The switches are approved for use with locking devices according to EN ISO 14119 and EN 292, Parts 1 and 2.

3SF13 safety switches with tumbler have a VDE test mark.

With a 3SF13 safety switch with tumbler it is possible to achieve Category 3 according to EN ISO 13849-1 or SIL 2 according to IEC 61508.

Category 4 according to EN ISO 13849-1 or SIL 3 according to IEC 61508 can be achieved by using an additional 3SE5 safety switch.

The 3SF1 safety switches are approved according to UL 508, UL 50 and UL 746-C.

SIRIUS 3SF1 Mechanical Safety Switches for AS-Interface

With Tumbler

3SF1, plastic enclosures with locking force greater than 1 200 N

Overview

Versions

- 1BA1: ASIsafe channel 1 on 1 NC contact from the actuator, and channel 2 on 1 NC contact from the solenoid
- 1BA3: ASIsafe channel 1 on the first NC contact from the actuator and channel 2 on the second NC contact from the actuator
- 1BA4: ASIsafe channel 1 on 2 NC contacts (two-channel) from the actuator, and channel 2 on 1 NC contact from the solenoid. The position switch transfers the information of actuators to a transfer channel because the discrepancy of the two actuator contacts is already evaluated in the switch.

The 3SF1324-1S.21-1BA4 safety switches are also recommended where there are several protective door tumblers and reliable diagnostics and quick restart capability of equipment is required.

- A response is received from the solenoid.
- No opening of the doors required after the solenoid is unlocked.

In connection with an ASIsafe MSS modular safety system or an ET 200SP F-CM AS-i Safety ST module, it is possible to achieve SIL 2 according to IEC 61508 or PL d according to ISO 13849-1. They comply with the standard EN ISO 14119. A TÜV certificate is available.

Features:

- Slow-action contacts
- 5 directions of approach
- Solenoid: Rated operational voltage 24 V DC
- 1 300 N locking force
- Degree of protection IP66/IP67 (IP69K)
- Status display with 4 LEDs 24 V DC; 1: AS-i, 2: FAULT, 3: F-IN1, 4: F-IN2

Comparison of versions



Safety switches	Contacts	Achievable safety level	Diagnostics	Reclosing condition after unlocking the solenoid (depending on the type of evaluation)
Type	Actuator/solenoid		Feedback from the solenoid	
3SF1324-1S.21-1BA1	1 NC/1 NC	SIL 1/PL c	✓	Door does <u>not</u> have to be opened
	1 NC/1 NC	SIL 2/PL d	✓	Door must be opened
3SF1324-1S.21-1BA3	2 NC/--	SIL 2/PL d	--	Door does <u>not</u> have to be opened
3SF1324-1S.21-1BA4	2 NC/1 NC	SIL 2/PL d	✓	Door does <u>not</u> have to be opened
3SF1324-1S.21-1BK4 (IP69K)	2 NC/1 NC	SIL 2/PL d	✓	Door does <u>not</u> have to be opened

✓ Available -- Not available

Selection and ordering data

Tumbler ¹⁾	Contacts Actuator/solenoid	SD	Complete units	PU (UNIT, SET, M)	PS*
		d	Article No.	Price per PU	

1 300 N locking force · Enclosure width 54 mm

 3SF1324-1SD21-1BA1	Spring-actuated locks				
	• With auxiliary release	1 NC/1 NC	⊕ 5	3SF1324-1SD21-1BA1	1 1 unit
		2 NC/--	⊕ 5	3SF1324-1SD21-1BA3	1 1 unit
		2 NC/1 NC	⊕ 5	3SF1324-1SD21-1BA4	1 1 unit
	- Degree of protection IP69 acc. to 60529; IP69K acc. to DIN 40050	2 NC/1 NC	⊕ 5	3SF1324-1SD21-1BK4	1 1 unit
• With auxiliary release with lock	1 NC/1 NC	⊕ 5	3SF1324-1SE21-1BA1	1 1 unit	
 3SF1324-1SF21-1BA1	• With escape release from the front	1 NC/1 NC	⊕ 5	3SF1324-1SF21-1BA1	1 1 unit
		2 NC/1 NC	⊕ 5	3SF1324-1SF21-1BA4	1 1 unit
	- Degree of protection IP69 acc. to 60529; IP69K acc. to DIN 40050	2 NC/1 NC	⊕ 5	3SF1324-1SF21-1BK4	1 1 unit
	• With escape release from the back and auxiliary release from the front	1 NC/1 NC	⊕ 5	3SF1324-1SG21-1BA1	1 1 unit
		2 NC/1 NC	⊕ 5	3SF1324-1SG21-1BA4	1 1 unit
- Degree of protection IP69 acc. to 60529; IP69K acc. to DIN 40050	2 NC/1 NC	⊕ 5	3SF1324-1SG21-1BK4	1 1 unit	
• With emergency release from the back and auxiliary release from the front	1 NC/1 NC	⊕ 5	3SF1324-1SJ21-1BA1	1 1 unit	
 3SF1324-1SB21-1BA1	Solenoid-locked	1 NC/1 NC	⊕ 5	3SF1324-1SB21-1BA1	1 1 unit
		2 NC/--	⊕ 5	3SF1324-1SB21-1BA3	1 1 unit

⊕ Positive opening according to IEC 60947-5-1, Appendix K.

¹⁾ Supplied without actuator. Please order separately. For actuators and optional accessories, see page 13/64.

SIRIUS 3SF1 Mechanical Safety Switches for AS-Interface

With Tumbler

3SF1, metal enclosures with locking force greater than 2 000 N

Overview

Version

- 1BA1: ASIsafe channel 1 on 1 NC contact from the actuator, and channel 2 on 1 NC contact from the solenoid

Features



- Slow-action contacts
- Solenoid: Rated operational voltage 24 V DC
- 2 600 N locking force
- Degree of protection IP66/IP67
- Status display with 4 LEDs 24 V DC;
1: AS-i, 2: FAULT, 3: F-IN1, 4: F-IN2

Comparison of versions

Safety switches	Contacts	Achievable safety level	Diagnostics	Reclosing condition after unlocking the solenoid (depending on the type of evaluation)
Type	Actuator/solenoid		Feedback from the solenoid	
3SF1314-1S.11-1BA1	1 NC/1 NC	SIL 1/PL c	✓	Door does <u>not</u> have to be opened

✓ Available

Selection and ordering data

Tumbler ¹⁾	Contacts Actuator/solenoid	SD	Complete units <input type="checkbox"/>	PU (UNIT, SET, M)	PS*
			Article No.	Price per PU	
2 600 N locking force · Enclosure width 54 mm					
Spring-actuated locks					
	• With auxiliary release	1 NC/1 NC	⊕ 5	3SF1314-1SD11-1BA1	1 1 unit
	• With auxiliary release with lock	1 NC/1 NC	⊕ 5	3SF1314-1SE11-1BA1	1 1 unit
3SF1314-1SD11-1BA1					
	• With escape release from the front	1 NC/1 NC	⊕ 5	3SF1314-1SF11-1BA1	1 1 unit
	• With escape release from the back and auxiliary release from the front	1 NC/1 NC	⊕ 5	3SF1314-1SG11-1BA1	1 1 unit
	• With escape release from the back and auxiliary release with lock from the front	1 NC/1 NC	⊕ 5	3SF1314-1SH11-1BA1	1 1 unit
	• With emergency release from the back and auxiliary release from the front	1 NC/1 NC	⊕ 5	3SF1314-1SJ11-1BA1	1 1 unit
3SF1314-1SF11-1BA1					
	Solenoid-locked	1 NC/1 NC	⊕ 5	3SF1314-1SB11-1BA1	1 1 unit
3SF1314-1SB11-1BA1					

⊕ Positive opening according to IEC 60947-5-1, Appendix K.

¹⁾ Supplied without actuator. Please order separately.

For actuators and optional accessories, see page 13/64.

Safety Hinge Switches

3SF1, plastic enclosures, enclosure width 31 mm according to EN 50047 / 50 mm

Overview

The 3SF1 safety hinge switches with safety-related communication can be directly connected using the AS-Interface bus system. The safety functions no longer have to be wired up conventionally.

With the 3SF1 hinge switches the ASIsafe electronics are integrated in the switch enclosure.

The hinge switches are provided for mounting on hinges.

There are two actuator variants here:

- Hollow shaft, inner diameter 8 mm, outer 12 mm
- Solid shaft, diameter 10 mm

For the ASIsafe version of the hinge switch, the basic switch and actuator head must be ordered separately. The basic switches correspond to the 3SF1 position switches (use only versions with snap-action contacts).

The provisions and approvals are the same as for the 3SF1 standard switches, [see page 13/85](#).

Selection and ordering data

Modular system

1 or 2 contacts · 3 LEDs · Degree of protection IP65 (31 mm) or IP66/IP67 (50 mm) · M12 device plug

Version	Contacts	LEDs	SD	Modular system	PU (UNIT, SET, M)	PS*
				Article No.	Price per PU	

Basic switches · Enclosure width 31 mm acc. to EN 50047



With Teflon plunger, with M12 device plug, 4-pole, channel 1 on NC contact, channel 2 on NC contact

Snap-action contacts

2 NC

24 V DC

⊕ 5

3SF1234-1LC05-1BA1

1 1 unit

3SF1234-1LC05-1BA1

Basic switches · Enclosure width 50 mm



With Teflon plunger, with M12 device plug, 4-pole, channel 1 on NC contact, channel 2 on M12 socket, right

Snap-action contacts

1 NC

24 V DC

⊕ 5

3SF1244-1LC05-1BA2

1 1 unit

3SF1244-1LC05-1BA2

Actuator heads



With hollow shaft

Operating angle 10°

5

3SE5000-0AU21

1 1 unit

3SE5000-0AU21



With solid shaft

Operating angle 10°

5

3SE5000-0AU22

1 1 unit

3SE5000-0AU22

⊕ Positive opening according to IEC 60947-5-1, Appendix K.

Safety Hinge Switches

3SF1, metal enclosures, enclosure width 31 mm according to EN 50047 / 40 mm according to EN 50041 / 56 mm

Overview

The 3SF1 safety hinge switches with safety-related communication can be directly connected using the AS-Interface bus system. The safety functions no longer have to be wired up conventionally.

With the 3SF1 hinge switches the ASIsafe electronics are integrated in the switch enclosure.

The hinge switches are provided for mounting on hinges.

There are two actuator variants here:

- Hollow shaft, inner diameter 8 mm, outer 12 mm
- Solid shaft, diameter 10 mm

For the ASIsafe version of the hinge switch, the basic switch and actuator head must be ordered separately. The basic switches correspond to the 3SF1 position switches (use only versions with snap-action contacts).

The provisions and approvals are the same as for the 3SF1 standard switches, [see page 13/85](#).

Selection and ordering data

Modular system

1 or 2 contacts · 3 LEDs · Degree of protection IP66/IP67 · M12 device plug

Version	Contacts	LEDs	SD	Modular system	PU (UNIT, SET, M)	PS*
				<input type="checkbox"/>		
				Article No.	Price per PU	

Basic switches · Enclosure width 31 mm acc. to EN 50047



With plunger

With M12 device plug, 4-pole, channel 1 on NC contact, channel 2 on NC contact

Snap-action contacts 2 NC 24 V DC ☉ 5

3SF1214-1LC05-1BA1

1 1 unit

3SF1214-1LC05-1BA1

Basic switches · Enclosure width 40 mm acc. to EN 50041



With M12 device plug, 4-pole, channel 1 on NC contact, channel 2 on NC contact

Snap-action contacts 2 NC 24 V DC ☉ 5

3SF1114-1LA00-1BA1

1 1 unit

3SF1114-1LA00-1BA1

Basic switches · Enclosure width 56 mm



With M12 device plug, 4-pole, channel 1 on NC contact, channel 2 on M12 socket, right

Snap-action contacts 1 NC 24 V DC ☉ 5

3SF1124-1LA00-1BA2

1 1 unit

3SF1124-1LA00-1BA2

Actuator heads



Hollow shaft

Operating angle 10°

5

3SE5000-0AU21

1 1 unit

3SE5000-0AU21



Solid shaft

Operating angle 10°

5

3SE5000-0AU22

1 1 unit

3SE5000-0AU22

☉ Positive opening according to IEC 60947-5-1, Appendix K.

Overview

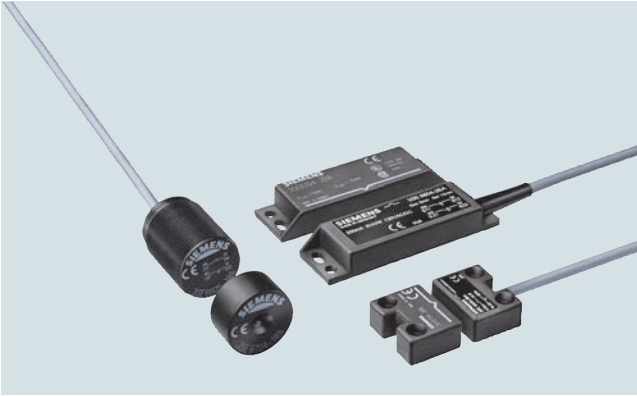

3SE66 contact blocks and 3SE67 switching magnets

A magnetically operated switch comprises a coded switching magnet and a contact block (sensor unit). The switch must be connected to a safety relay, e.g. SIRIUS 3SK1, or a bus system, e.g. SIMATIC ET 200SP, for evaluation. The switches use reed contacts as mechanical contacts. The status of the contacts is monitored using an evaluation unit.

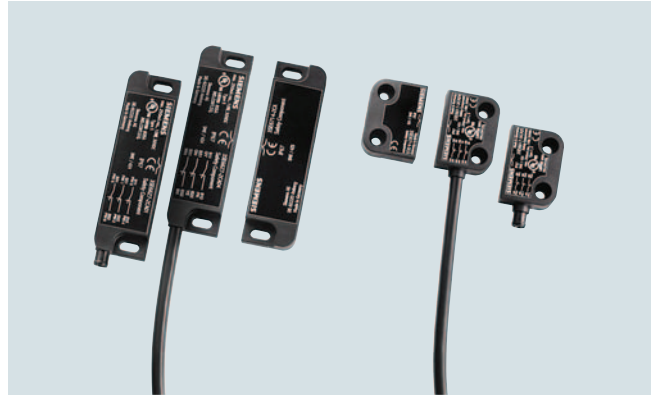

3SE66 contact blocks and 3SE67 switching magnets, supplementary range in new design

Safety relays

3SK safety relays can be used worldwide since they possess all the required certification. Since they satisfy the most exacting safety requirements, they are suitable for all kinds of safety applications.

The following can be selected:

- 3SK1 Standard basic units: simple and compact to satisfy all the essential requirements of safety sensor monitoring systems
- 3SK1 Advanced basic units: multifunctional series with relay enabling circuits, semiconductor outputs or time-delay outputs
- 3SK2 basic units: multifunctional series whose functionality is parameterized using software. The basic units have solid-state outputs. Relay outputs from the 3SK1 portfolio can also be connected via device connectors.
- Expansion units for inputs and outputs

The 3SE6806 safety relay is also available with two floating enabling circuits (safe circuits) as NO contact circuits and one floating signaling circuit as an NC contact circuit.

Benefits

Standard range

- Non-contact round, rectangular, small (25 mm x 33 mm) and larger (25 mm x 88 mm) versions
- Small, compact, safe
- Simple mounting with alignment of sensor and actuator, and concealed installation also easy
- Suitable for restricted spaces

Supplementary range

- New design for rectangular shape
- More functionality
- Greater switching intervals and a larger horizontal or vertical displacement
- Various mounting positions possible (e.g. at 90° offset)
- SIL 3 and PL e diagnostics possible because there are two safety contacts and one signaling contact
- LED variant
- Fast connection possible using plug-in variants

Application

SIRIUS 3SE6 magnetically operated switches are designed for mounting on movable protective guards (hoods, hinged covers, doors, etc.). Evaluation can be performed by means of a safety relay or through connection to a bus system.

The 3SE66 non-contact, magnetically operated safety switches stand out due to their enclosed design with degree of protection IP67. Since they are coded, they do not have to be concealed when installed. They are particularly suitable therefore for areas exposed to contamination, cleaning or disinfecting.

A magnetic monitoring system comprises one or more magnetically operated switches and an evaluation unit, e.g. a safety relay. When contact blocks 1 NO + 1 NC (+ 1 NC signaling contact) or 2 NC (+ 1 NC signaling contact) are used, the 3SK safety relay, for example, provides a high degree of protection against manipulation and can be installed in safety circuits up to SIL 3 according to IEC 62061 and PL e according to EN ISO 13849-1.

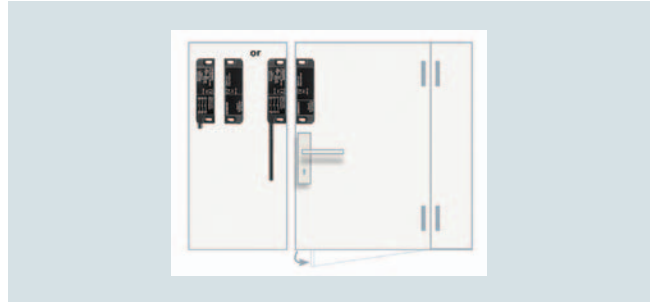



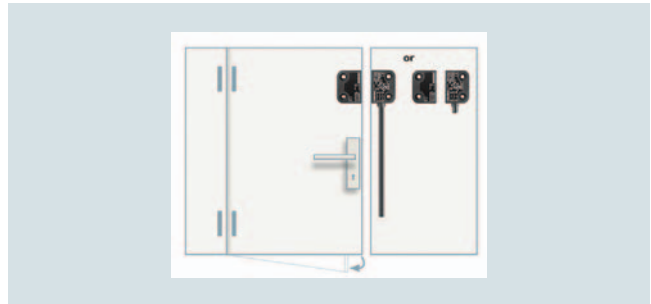





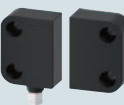

Non-contact safety magnetically operated switches (with plug or cable) for right-hinged door



Non-contact safety magnetically operated switches (with plug or cable) for left-hinged door

Combination of monitoring units and magnetically operated switches

Monitoring units		Magnetically operated switches (contact block + switching magnet)			Achievable SIL (IEC 61508, IEC 62061) Performance Level (EN ISO 13849-1)	
		1 NO + 1 NC 3SE6605-.BA..	2 NC 3SE6604-2BA.. 1 NO + 2 NC 3SE6606-2BA04	--		
		 3SE6704-.BA	 3SE6704-2BA			
		1 NO + 1 NC (+ 1 NC signaling contact) 3SE6616-3CA01 3SE6626-3CA01	2 NC; 2 NC (+ 1 NC signaling contact) 3SE6614-4CA01 3SE6624-4CA01 3SE6617-2CA01 3SE6627-2CA01 3SE6617-2CA04 3SE6627-2CA04	2 NC (+ 1 NC signaling contact) 3SE6617-3CA01 3SE6627-3CA01 3SE6617-3CA04 3SE6627-3CA04		
		 3SE6714-3CA 3SE6724-3CA	 3SE6714-2CA 3SE6724-2CA	 3SE6714-3CA 3SE6724-3CA		
Relay output						
SIRIUS safety relays	3SK1121, 3TK2826		✓	✓	✓	SIL 3/PL e
Solid-state outputs						
SIRIUS safety relays	3SK1112, 3SK1122		--/✓	✓	✓	SIL 3/PL e
	3SK2112, 3SK2122		✓	✓	✓	SIL 3/PL e
ASIsafe compact safety modules	3RK1205, 3RK1405		--	✓	✓	SIL 3/PL e
Modular Safety System (MSS)	3RK3		✓	✓	✓	SIL 3/PL e
SIMATIC S7-1200F	F-DI 16 x 24 V DC		✓	✓	✓	SIL 3/PL e
SIMATIC ET 200SP PROFIsafe	4/8 F-DI, 24 V DC		✓	✓	✓	SIL 3/PL e
SIMATIC ET 200eco	4/8 F-DI, 24 V DC		✓	✓	✓	SIL 3/PL e
SIMATIC ET 200pro	8/16 F-DI, 24 V DC, 4/8 F-DI/4 F-DQ 2 A, 24 V DC, F-Switch		✓	✓	✓	SIL 3/PL e
SIMATIC ET 200SP	8F-DI, 24 V DC F-PM-E 24 V DC		✓	✓	✓	SIL 3/PL e
SIMATIC ET 200MP	16 F-DI, 24 V DC		✓	✓	✓	SIL 3/PL e

✓ Suitable magnetically operated switch

-- Not available

SIRIUS 3SE6 Non-Contact Safety Switches

Magnet

3SE66, 3SE67 magnetically operated switches

Selection and ordering data









Version	Size	Contacts	SD	Article No.	Price per PU	PU (UNIT, SET, M)	PS*
	mm		d				
Standard range – Round sensor units							
 3SE6704-1BA	Switching magnet (coded)	M30	--	2	3SE6704-1BA	1	1 unit
 3SE6505-1BA	Contact blocks						
	• With cable 3 m	M30	1 NO + 1 NC	2	3SE6605-1BA	1	1 unit
	• With M12 plug, 4-pole	M30	1 NO + 1 NC	2	3SE6605-1BA02	1	1 unit
Standard range – Rectangular sensor units							
 3SE6704-2BA	Switching magnet (coded)	25 x 88	--	2	3SE6704-2BA	1	1 unit
 3SE660.-2BA	Contact blocks						
	• With cable 3 m	25 x 88	1 NO + 1 NC	2	3SE6605-2BA	1	1 unit
			2 NC	2	3SE6604-2BA	1	1 unit
			1 NO + 2 NC	10	3SE6606-2BA04	1	1 unit
	• With cable 10 m	25 x 88	1 NO + 1 NC	5	3SE6605-2BA10	1	1 unit
			2 NC	2	3SE6604-2BA10	1	1 unit
	• With M8 plug, 4-pole	25 x 88	1 NO + 1 NC	2	3SE6605-2BA01	1	1 unit
			2 NC	2	3SE6604-2BA01	1	1 unit
 3SE660.-3BA	Switching magnet (coded)	25 x 33	--	2	3SE6704-3BA	1	1 unit
	Contact blocks						
	• With cable 3 m	25 x 33	1 NO + 1 NC	2	3SE6605-3BA	1	1 unit
	• With cable 5 m			2	3SE6605-3BA05	1	1 unit
	• With cable 10 m			2	3SE6605-3BA10	1	1 unit
Supplementary range in new design – Rectangular sensor units for left-hinged door							
 3SE6714-2CA	Switching magnets (coded)	25 x 88	--	5	3SE6714-2CA	1	1 unit
	• Same level			5	3SE6724-2CA	1	1 unit
	• 90° offset			5			
 3SE6614-4CA01	Contact blocks						
	• With M8 plug, 4-pole, with LED	25 x 88	2 NC	5	3SE6614-4CA01	1	1 unit
	• 8 mm Ø, latching connection, plug, 6-pole		2 NC + 1 NC ¹⁾	5	3SE6617-2CA01	1	1 unit
	• With cable 3 m		2 NC + 1 NC ¹⁾	5	3SE6617-2CA04	1	1 unit
 3SE6714-3CA	Switching magnets (coded)	26 x 36	--	5	3SE6714-3CA	1	1 unit
	• Same level			5	3SE6724-3CA	1	1 unit
	• 90° offset			5			
 3SE6616-3CA01	Contact blocks						
	• 8 mm Ø, latching connection, plug, 6-pole	26 x 36	1 NO + 1 NC + 1 NC ¹⁾	5	3SE6616-3CA01	1	1 unit
			2 NC + 1 NC ¹⁾	5	3SE6617-3CA01	1	1 unit
	• With cable 3 m		2 NC + 1 NC ¹⁾	5	3SE6617-3CA04	1	1 unit

¹⁾ The NC is a signaling contact, not a safety contact.

SIRIUS 3SE6 Non-Contact Safety Switches

Magnet

3SE66, 3SE67 magnetically operated switches

Version	Size	Contacts	SD	Article No.	Price per PU	PU (UNIT, SET, M)	PS*
	mm		d				
Supplementary range in new design – Rectangular sensor units for right-hinged door							
	Switching magnets (coded)						
	• Same level	25 x 88	--	5	3SE6714-2CA		1 1 unit
	• 90° offset			5	3SE6724-2CA		1 1 unit
	Contact blocks						
	• With M8 plug, 4-pole, with LED	25 x 88	2 NC	5	3SE6624-4CA01		1 1 unit
	• 8 mm Ø, latching connection, plug, 6-pole		2 NC + 1 NC ¹⁾	5	3SE6627-2CA01		1 1 unit
	• With cable 3 m		2 NC + 1 NC ¹⁾	5	3SE6627-2CA04		1 1 unit
	Switching magnets (coded)						
	• Same level	26 x 36	--	5	3SE6714-3CA		1 1 unit
	• 90° offset			5	3SE6724-3CA		1 1 unit
	Contact blocks						
	• 8 mm Ø, latching connection, plug, 6-pole	26 x 36	1 NO + 1 NC + 1 NC ¹⁾	5	3SE6626-3CA01		1 1 unit
			2 NC + 1 NC ¹⁾	5	3SE6627-3CA01		1 1 unit
	• With cable 3 m		2 NC + 1 NC ¹⁾	5	3SE6627-3CA04		1 1 unit
Accessories for standard range							
	Spacer						
		25 x 88	--	2	3SX3260		1 1 unit
		25 x 33	--	5	3SX3261		1 1 unit
	Coupling						
	With connecting cable, 5 m						
	• With M8 socket, 4-pole		--	5	3SX5601-3GA05		1 1 unit
Accessories for supplementary range in new design							
	Spacer						
		25 x 88	--	5	3SX5600-2GA01		1 1 unit
		26 x 36	--	5	3SX5600-2GA02		1 1 unit
	Coupling						
	With connecting cable, 5 m						
	• With M8 socket, 4-pole		--	5	3SX5601-3GA05		1 1 unit
	• With 8 mm Ø socket, 8 mm, latching connection, 6-pole		--	5	3SX5601-4GA05		1 1 unit

¹⁾ The second NC is a signaling contact, not a safety contact.

SIRIUS 3SE6 Non-Contact Safety Switches

Magnet

3SE66, 3SE67 magnetically operated switches

Version	Rated control voltage	Number of sensors	Enabling/signaling circuits	SD	Article No.	Price per PU	PU (UNIT, SET, M)	PS*
---------	-----------------------	-------------------	-----------------------------	----	-------------	--------------	-------------------	-----

Monitoring units

3SK1 safety relays

Standard or Advanced basic units

With relay output	24 V DC	6 ¹⁾	3 NO/1 NC	▶	3SK1121-1AB40		1	1 unit
With semiconductor output	24 V DC	1	2 x F-DQ/ 1 QM	2	3SK1112-1BB40		1	1 unit



3SK1121-1AB40

3SK2 safety relays

Basic units

With semiconductor output	24 V DC	5	2 x F-DQ/ 1 QM	2	3SK2112-1AA10		1	1 unit
		10	4 x F-DQ/ 2 QM	2	3SK2122-1AA10		1	1 unit



3SK2112-1AA10

¹⁾ Only when up to 5 3SK1220 expansion units are used, [see page 13/25](#).

For more monitoring units, [see page 13/109](#).

Overview



Non-contact RFID safety switches with maximum tamper resistance

RFID 3SE63 non-contact safety switches comply with the highest safety requirements, SIL 3 or Cat. 4, for monitoring the positions of movable protective devices.

An RFID safety switch consists of a coded RFID switch with an 8-pole M12 connection plug and an identical RFID actuator.

The switch is available in several versions:

- Family coded with M12 plug or with additional 18 N magnetic catch as an option
- Individually coded, programmable once, with M12 plug or with additional 18 N magnetic catch as an option
- Individually coded, programmable more than once (an unlimited number of times), with M12 plug or variant with additional 18 N magnetic catch

The actuator is therefore available in two versions:

- Standard
- With 18 N magnetic catch

The magnetic catch keeps doors and hinge switches closed with permanent magnets.

Mounting and maintenance

Various options for mounting save on enclosure variants:

- Mounting of the switch on the right or left side
- The actuator can be mounted on all sides

Quick and easy mounting thanks to universal mounting holes:

- Standard gauge/holes for 3SE6 magnetically operated switches
- Fine adjustment thanks to slotted holes

Little adjustment or maintenance required:

- Threshold indication by LED display on the switch for quick and easy adjustment during mounting and maintenance
- Molded switch allows it to be used as an end stop for small and medium-sized doors

Note:

- Keep metal parts and cuttings away from the vicinity of the switch
- Minimum distance between two switches 100 mm

Optional accessories (mounting)

- Covers for sealing mounting holes, also suitable for tamper-proofing screw fixings
- Spacers (approx. 3 mm high) to facilitate cleaning under the installation surface when using high-pressure cleaners, for example

Coding

Family coded

These safety switches are delivered ready to use, i. e. no programming is necessary.

Individually coded, programmable once

The assignment of safety switch and actuator thus created is irreversible.

The actuator is programmed simply by routine during startup, thus permanently preventing any form of tampering by means of a replacement actuator.

Individually coded, programmable several times

The procedure for programming a new actuator can be repeated an unlimited number of times. When a new actuator is programmed the previous code becomes invalid. A protected coding process allows new actuators to be programmed for service purposes.

After this, a ten-minute lockout provides increased tamper protection. The green LED flashes until the lockout time has ended and the new actuator has been detected. If the operational voltage is interrupted during this time, the ten-minute guard time is restarted.

Programming procedure for individual coding

1. Apply operational voltage to safety sensor
2. Move actuator into detection range: red LED lights up, yellow LED flashes (1 Hz)
3. After 10 s it changes to a shorter flashing frequency (3 Hz). In this state switch off operational voltage.
4. After the next time the operational voltage is switched on, the actuator is detected again to activate the programmed actuator code. The activated code is thus stored permanently.

Diagnostics

The RFID safety switch indicates its operating state including faults by means of the LED indicator in the switch and the short-circuit proof diagnostics output. The signals can then be used for central displays or non-safety-related control tasks.

There are the following diagnostics functions:

- Crossover monitoring
- Open-circuit monitoring
- External voltage monitoring
- Ambient temperature too high
- Wrong or defective actuator
- Switching interval threshold identification with LED display

The signal combination "diagnostics output switched off" and "safety outputs still switched on" can be used to move the machine into a controlled stop position.

Any crossover or a fault that is not currently compromising the safe function of a safety switch results in the disconnection of the safety channels after a 30-minute delay. However, the diagnostics output switches off instantaneously.

Mode of operation of the diagnostics LEDs

The safety switch indicates not only its operating state, but also faults by means of LEDs in three colors at the ends of the RFID switch.

- The green LED indicates readiness for operation when the control supply voltage is connected.
- The yellow LED indicates that there is an actuator in detection range. If the actuator is in the switching interval threshold, this is indicated by flashing. This flashing can be used to identify a change in the distance between sensor and actuator at an early stage (e.g. as a result of the sagging of a protective door). The installation should be tested before the distance increases further, the safety outputs switch off and the machine stops.
- The red LED indicates the individual causes of the fault by means of defined flashing frequencies.

Benefits

- Maximum tamper resistance by means of individual coding of switches and actuators at the highest safety level
- Plastic enclosure with integrated plug
- Two solid-state short-circuit proof safety outputs, each 250 mA
- Integrated crossover, open circuit and external voltage monitoring, with series circuit as far as the control cabinet
- Safety and diagnostics signals can be connected in series
- Series connection of safety circuits in Cat. 4/PL e/SIL 3
- LED status indication including switching interval threshold indication for quick and easy adjustment during installation and maintenance
- Short-circuit proof conventional diagnostics output
- Optional version with magnetic catch for interlocking hinge switches or small doors even when de-energized
- Highly rugged thanks to the use of tested enclosure materials, resistant to aggressive cleaning products, with a degree of protection of up to IP69K
IP69 does not automatically mean that it can be used outdoors. The devices must be installed with corresponding protection for this purpose. UV radiation additionally affects the enclosure
- Fine adjustment thanks to slotted holes
- Little adjustment or maintenance required
- Molded switch allows it to be used as an end stop for small and medium-sized doors

Application

RFID non-contact safety switches are designed for use in safety circuits, and are used to monitor the positions of movable protective devices. They monitor the positions of rotating, laterally sliding or removable protective devices using the coded electronic actuator.

Their high degree of protection (IP69K) and the use of cleaning-product-resistant materials means that these switches are optimized for use under extreme environmental conditions.

Their electronic operating principle makes these switches ideal for metalworking machinery.

The switches have a larger switching interval and switching displacement than mechanical switches, improve the mounting tolerance of the protective door, and offer a wide range of diagnostics options.

The RFID switches can be connected to all standard evaluation units suitable for solid-state inputs and in which the built-in crossover monitoring function can be deactivated, e.g.:

Monitoring units	
Relay output	
SIRIUS safety relays	3SK1111-.AB30, 3SK1121
SIRIUS safety relays	3TK2826-.BB4.
Solid-state outputs	
SIRIUS safety relays	3SK1112, 3SK1122, 3SK2112, 3SK2122
SIRIUS safety relays	3TK2841, 3TK2842, 3TK2845 3TK2853-.BB40
Modular Safety System (MSS)	
SIMATIC ET 200S	6ES7138-4FA0-.0AB0 6ES7138-4FC0-.0AB0
SIMATIC ET 200M	6ES7326-1BK0-.0AB0
SIMATIC ET 200eco	6ES7148-3FA00-0XB0
SIMATIC ET 200pro	6ES7148-4F.00-0AB0
SIMATIC ET 200SP	6ES7136-6BA00-0CA0 6ES7136-6PA00-0BC0
SIMATIC ET 200MP	6ES7526-3BH00-0AB0
SIMATIC S7-1200F	6ES7226-6BA32-0XB0

These safety categories can be achieved in safety circuits:

- Category 4 according to EN ISO 13849-1
- PL e according to EN ISO 13849-1
- SIL 3 according to IEC 61508

Technical specifications

Type	3SE63
General data	
Standards	IEC 60947-5-3, IEC 61508, EN ISO 13849-1, EN ISO 14119
Enclosure material	Glass-fiber reinforced thermoplast, self-extinguishing
Degree of protection	IP65/IP67/IP69K
Ambient temperature	
• During operation	°C -25 ... +70
• During storage, transport	°C -25 ... +85
Shock resistance	30 g/11 ms
Vibration resistance	10 ... 55 Hz, amplitude 1 mm

Type	3SE63
Electrical specifications	
Rated insulation voltage U_i	V 32
Degree of pollution according to IEC 60664-1	3
Rated impulse withstand voltage U_{imp}	V 800
Rated conditional short-circuit current	A 100
Rated operational voltage U_e (PELV acc. to EN 60204-1)	V DC 24 -15/+10%
Protection class	II
Overvoltage category	III
Rated operational current I_e	A 0.6
Lowest operating current I_m	mA 0.5
No-load current I_0	mA 35

Type	3SE63	
Inputs/outputs		
Safety inputs X1/X2		
• Input voltage	V DC	24 –15/+10%
• Power consumption per input	mA	5
Safety outputs OSSD1/OSSD2		
		p operation
• Max. rated operating current $I_{e\ max}$	A	0.25
• Rated operational current $I_e/DC-12/DC-13$ at U_e	A	0.25
• Voltage drop U_e	V	< 1
• Switching frequency	Hz	1
• Response time, max.	ms	100
• Risk time, max.	ms	200
• Recovery, max.	s	5
Diagnostics output		
		p operation
• Max. rated operating current $I_{e2\ max}$	A	0.05
• Rated operational current $I_e/DC-12/DC-13$ at U_e	A	0.05
• Voltage drop U_e	V	< 2
• Operational current	mA	150
• Conductor capacity, max.	nF	50

Pin assignment

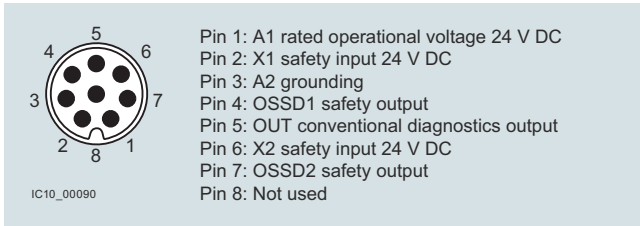

Pin assignment

Directions of approach and switching interval

The side area permits a maximum height offset of the switch and actuator of ± 8 mm (e.g. mounting tolerance or due to sagging of the protective door). The transverse offset also equals max. ± 18 mm.

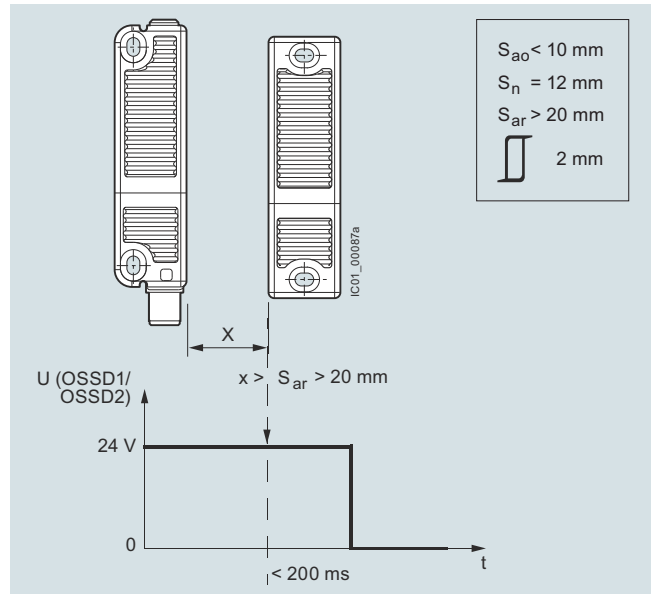
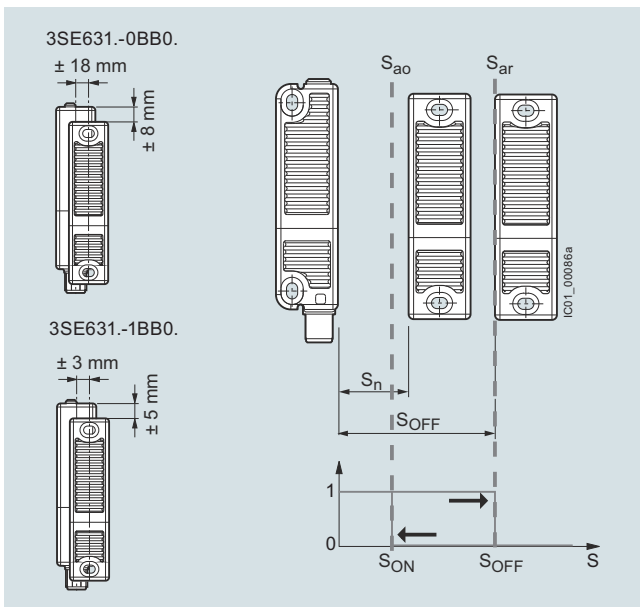

Dimension drawings

RFID switch
3SE6315

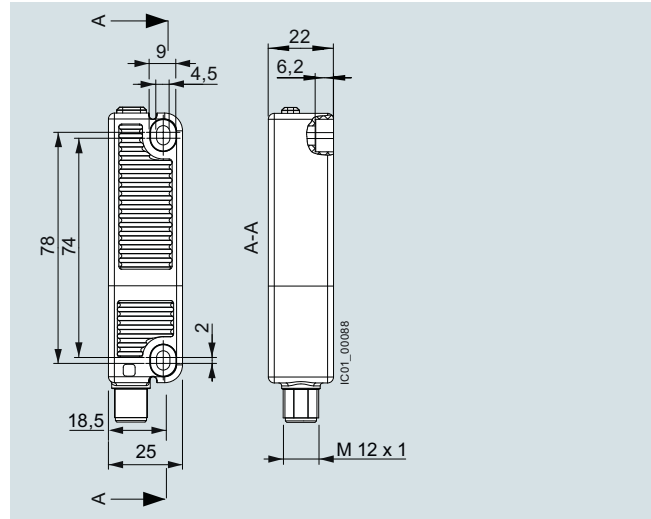



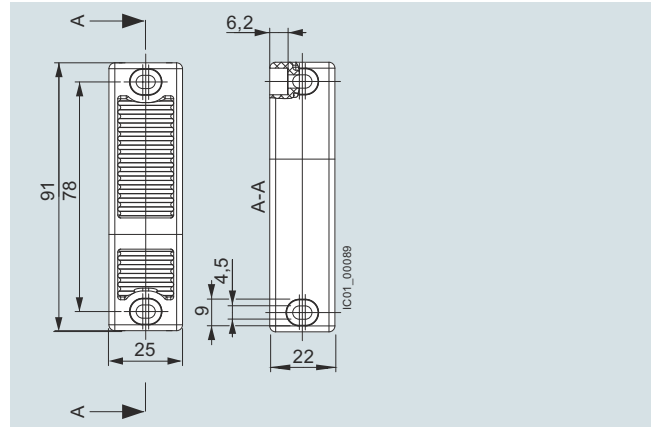

RFID actuator
3SE6310



Selection and ordering data

With M12 connection plug, 8-pole

Version/coding	Latching/length	SD	Article No.	Price per PU	PU (UNIT, SET, M)	PS*
Rectangular safety switches 91 mm x 25 mm¹⁾						
RFID safety switch						
 <p>3SE6315</p>	• Family coded	None	2	3SE6315-0BB01	1	1 unit
		With 18 N magnetic catch	2	3SE6315-1BB01	1	1 unit
	• Individually coded, programmable several times	None	2	3SE6315-0BB02	1	1 unit
		With 18 N magnetic catch	5	3SE6315-1BB02	1	1 unit
	• Individually coded, programmable once	None	2	3SE6315-0BB03	1	1 unit
		With 18 N magnetic catch	5	3SE6315-1BB03	1	1 unit
RFID actuator						
 <p>3SE6310</p>	• Standard	None	2	3SE6310-0BC01	1	1 unit
		With 18 N magnetic catch	2	3SE6310-1BC01	1	1 unit
Optional accessories						
Covers and spacers						
 <p>3SX5600-1G</p>			2	3SX5600-1G	1	1 unit
	One pack (1 unit) contains 8 covers and 4 spacers					
Connecting cables, 8-pole, with 1 straight M12 socket						
 <p>3SX5601-2GA03</p>		Length 3 m	2	3SX5601-2GA03	1	1 unit
		Length 5 m	2	3SX5601-2GA05	1	1 unit
		Length 10 m	2	3SX5601-2GA10	1	1 unit
Rated voltage 30 V						
Rated current 2 A						

¹⁾ Not connectable via AS-i modules.

For more monitoring units, [see page 13/109](#).

Position and Safety Switches

SIRIUS 3SE5 Mechanical Position Switches

General data

Type	3SE63	
Inputs/outputs		
Safety inputs X1/X2		
• Input voltage	V DC	24 –15/+10%
• Power consumption per input	mA	5
Safety outputs OSSD1/OSSD2		
		p operation
• Max. rated operating current $I_{e\ max}$	A	0.25
• Rated operational current $I_e/DC-12/DC-13$ at U_e	A	0.25
• Voltage drop U_e	V	< 1
• Switching frequency	Hz	1
• Response time, max.	ms	100
• Risk time, max.	ms	200
• Recovery, max.	s	5
Diagnostics output		
		p operation
• Max. rated operating current $I_{e2\ max}$	A	0.05
• Rated operational current $I_e/DC-12/DC-13$ at U_e	A	0.05
• Voltage drop U_e	V	< 2
• Operational current	mA	150
• Conductor capacity, max.	nF	50

Pin assignment

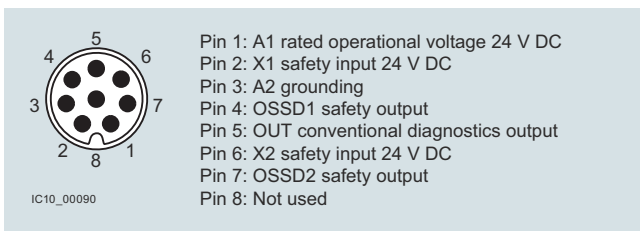

Pin assignment

Directions of approach and switching interval

The side area permits a maximum height offset of the switch and actuator of ± 8 mm (e.g. mounting tolerance or due to sagging of the protective door). The transverse offset also equals max. ± 18 mm.

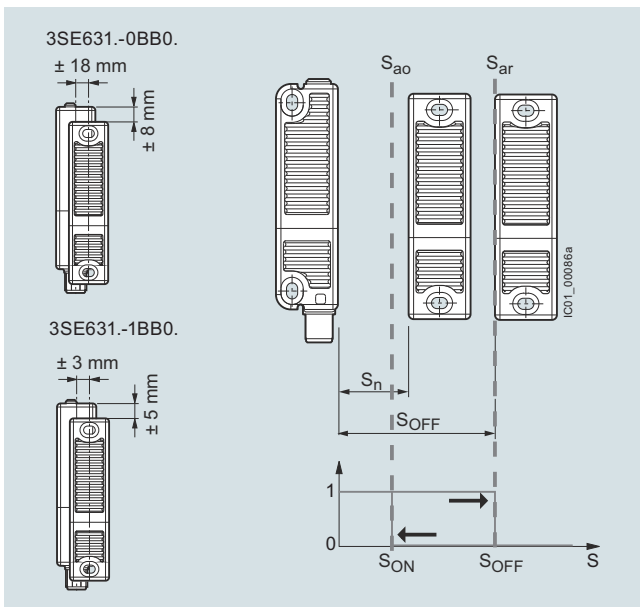

Switching interval: Output signal with hysteresis

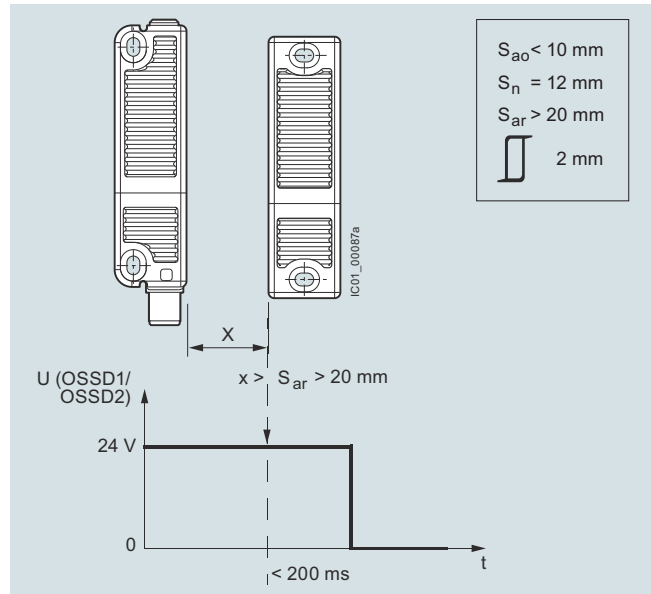

Switching interval: Output signal with OFF delay

Dimension drawings

RFID switch 3SE6315

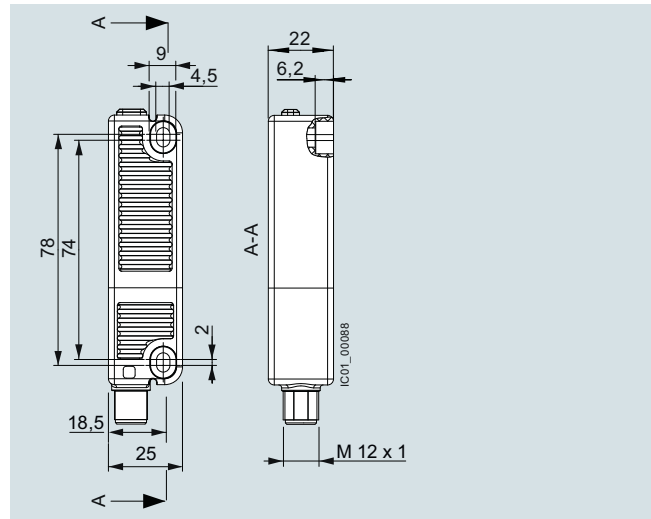



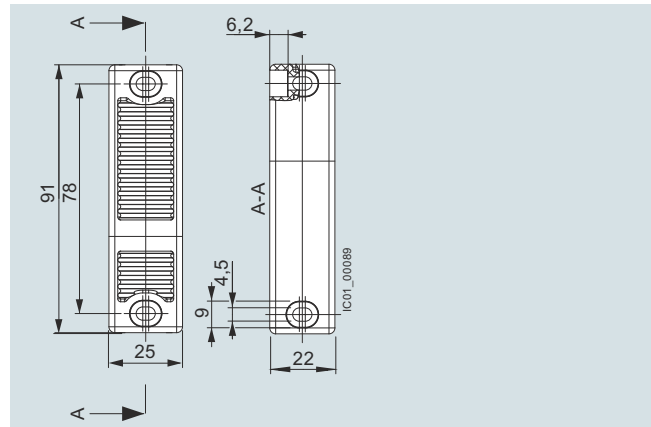

RFID actuator 3SE6310

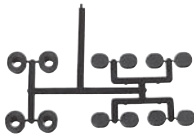

Selection and ordering data

With M12 connection plug, 8-pole

Version/coding	Latching/length	SD	Article No.	Price per PU	PU (UNIT, SET, M)	PS*
Rectangular safety switches 91 mm x 25 mm¹⁾						
RFID safety switch						
 <p>3SE6315</p>	• Family coded	None	2	3SE6315-0BB01	1	1 unit
		With 18 N magnetic catch	2	3SE6315-1BB01	1	1 unit
	• Individually coded, programmable several times	None	2	3SE6315-0BB02	1	1 unit
		With 18 N magnetic catch	5	3SE6315-1BB02	1	1 unit
	• Individually coded, programmable once	None	2	3SE6315-0BB03	1	1 unit
		With 18 N magnetic catch	5	3SE6315-1BB03	1	1 unit
RFID actuator						
 <p>3SE6310</p>	• Standard	None	2	3SE6310-0BC01	1	1 unit
		With 18 N magnetic catch	2	3SE6310-1BC01	1	1 unit
Optional accessories						
Covers and spacers						
 <p>3SX5600-1G</p>			2	3SX5600-1G	1	1 unit
	One pack (1 unit) contains 8 covers and 4 spacers					
Connecting cables, 8-pole, with 1 straight M12 socket						
 <p>3SX5601-2GA03</p>		Length 3 m	2	3SX5601-2GA03	1	1 unit
		Length 5 m	2	3SX5601-2GA05	1	1 unit
		Length 10 m	2	3SX5601-2GA10	1	1 unit
Rated voltage 30 V Rated current 2 A						

¹⁾ Not connectable via AS-i modules.

For more monitoring units, [see page 13/109](#).

Features

Modular plug-in



Product Description

These heavy duty switches define the industry standard with versatility of design and high reliability for low maintenance, installation and inventory costs. Standard Viton gaskets, seals and boots and a zinc die cast enclosure provide exceptional chemical resistance to the common coolants, cleansing agents, and hydraulic fluids found in machine tool, automotive, waste water treatment and other heavy duty industrial applications. Mounting dimensions accommodate both U.S. and DIN standards for easy retrofit installations.

Features

- Manufactured to take the physical and environmental abuse (including cutting fluids and chemicals) of harsh industrial environments
- Modular, plug-in components (head and switch body) provide application flexibility, reduced inventory and less downtime
- Chemical resistant Viton gaskets, seals and boots are standard, and so are captive, posi-drive screws
- A special internal seal on the switch body prevents fluid from entering even when the operating head is not attached
- 600V rating, ridge-topped contacts and wiping action assure continuity even to logic level circuits
- Factory wired cable features a 350 pound pullout capacity
- Keyed, four direction head positioning. Standard 5° pre-travel and 90° total travel
- Rotary heads are field convertible CW, CCW, or both, without special tools

Standards and Certifications

- UL Listed
- CSA certified
- CE (single pole only)
- RoHS Compliant



Factory Sealed



Product Description

These heavy duty switches were specifically designed to withstand the penetrating properties of cutting fluids and coolants, such as those used in the automotive industry, as well as extreme shock, vibration and temperature fluctuations. The one-piece, epoxy filled switch body is prewired at the factory to ensure leak-proof, submersible performance. This unique construction positively stops fluid from finding its way to any and all critical connections. Our 6P+ switches can be ordered in separate components or as complete assembled devices. They are available with prewired 16 AWG cables or mini-connectors. Standard and custom cable lengths are available, and these switches use the same operating heads as the standard 3SE03 switches.

Features

- Manufactured to take the physical and environmental abuse (including cutting fluids and chemicals) of harsh industrial environments
- Modular, plug-in components (head and switch body) provide application flexibility, reduced inventory and less downtime
- Chemical resistant Viton gaskets, seals and boots are standard, and so are captive, posi-drive screws
- A special internal seal on the switch body prevents fluid from entering even when the operating head is not attached
- 600V rating, ridge-topped contacts and wiping action assure continuity even to logic level circuits
- Factory wired cable features a 350 pound pullout capacity
- Keyed, four direction head positioning. Standard 5° pre-travel and 90° total travel
- Rotary heads are field convertible CW, CCW, or both, without special tools

!! DANGER !!

THIS SENSOR IS NOT A SAFETY DEVICE AND IS NOT INTENDED TO BE USED AS A SAFETY DEVICE.

3SE03 switches are designed only to detect and read certain data in an electronic manner and perform no use apart from that, specifically no safety-related use. This sensor product does not include self-checking redundant circuitry, and the failure of this sensor product could cause either an energized or de-energized output condition, which could result in death, serious bodily injury, or property damage.

For safety-rated limit switches, [see page 13/7](#).

3SE03 Heavy Duty Limit Switches

Modular, plug-in and NEMA type 6P submersible

Technical data

Type	Modular, Plug-in and NEMA Type 6P Submersible					
Mechanical life	Side rotary: 13 x 10 ⁶ make-break operations minimum All others: 10 x 10 ⁶ make-break operations minimum					
Electrical life	Single Pole: 1 x 10 ⁶ operations typical at full load Double Pole: 1 x 10 ⁵ operations typical at full load					
Switching frequency	8 x 10 ³ make-break operations per hour (maximum)					
Operating point accuracy	Side operated: 0.0012 in. (modular, plug-in housing) Side rotary: 0.0014 in. (modular plug-in). Top operated: 0.0003 in. (modular, plug-in housing)					
Cable entry	1/2 in.-NPT, Prewired Cable or Prewired Receptacle with Pin Connector					
Ambient temperature	Without Cable: -10° to +121°C, 14° to 250°F With Cable: -10° to +105°C, 14° to 221°F					
Degree of protection	NEMA Type 1, 3, 3S, 4, 4X, 6, 6P, 13; IP67					
Conductor size	22–12 AWG (modular, plug-in housing), single or stranded wire 5 or 9 conductor, 16 AWG yellow jacketed type SOOW-A cable (prewired cable) 5 or 9 pin, 0.87 in. (22 mm) diameter receptacle (prewired receptacle with pin connector)					
Mounting	Any position					
Tightening Torque	Switch body screws: 25–30 lb-in. Operating head screws: 14–18 lb-in.					
NEMA rating	DC, NEMA R300		AC, NEMA A600			
Maximum current at	125V	250V	120V	240V	480V	600V
Make	0.22A	0.11A	60A	30A	15A	12A
Break	0.22A	0.11A	6A	3A	1.5A	1.2A
Max. volt-ampere						
Make	28VA	28VA	7200VA	7200VA	7200VA	7200VA
Break	28VA	28VA	720VA	720VA	720VA	720VA
Rated thermal current	DC, 1A		AC, 10A			
Rated operating voltage	DC, 300V		AC, 600V			

Operating temperature ^{1) 2)}

Temperature rating	Operation		Temperature range	
	Type	Return	Without cable	With cable
1	Side rotary ³⁾	Momentary CW only or CCW only	10°F to 200°F -12°C to 94°C	10°F to 200°F -12°C to 94°C
2	Center neutral Side rotary Side plunger Two-sided plunger Roller side plunger ⁴⁾	Momentary CW or CCW Maintained Momentary Maintained Momentary	14°F to 200°F -10°C to 94°C	14°F to 200°F -10°C to 94°C
3	Top plunger Top roller plunger ⁴⁾ Wobble head	Momentary Momentary Momentary	14°F to 250°F -10°C to 121°C	14°F to 221°F -10°C to 105°C

1) Temperature ranges below +32°F (0°C) are based on absence of freezing moisture or water.

2) For temperature rating of specific switch, refer to page 13/70, Operating Heads.

3) For CW only or CCW only operation, upper temperature limit increases to 250°F (121°C) without cable, and 221°F (105°C) with pre-wired cable.

4) Roller direction can be converted in the field.











Limit Switches

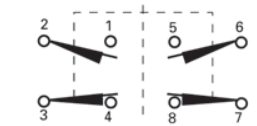



3SE03 Heavy Duty Limit Switches

Modular, plug-in metal housing

LIMIT SWITCHES AND SAFETY 13

Complete switches without lever - threaded cable entry:

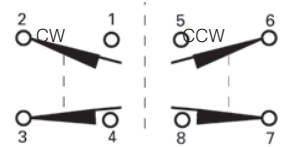
	Plug-In module type	Standard single pole 1 NO + 1 NC (3SE03-SA)	Standard double pole 2 NO + 2 NC (3SE03-SB)				
	Receptacle type surface mount	Single pole (3SE03-RA) 	Double pole (3SE03-RB) 				
Operating head type		Composite catalog number consisting of head, module and receptacle					
		DT	Catalog Number	List Price \$ 1 unit	DT	Catalog Number	List Price \$ 1 unit
	Side rotary CW and CCW operation convertible to CW only or CCW only	Standard momentary (3SE03-DR1)	▶ 3SE03-AR1 ^①		▶ 3SE03-BR1 ^①		
		Standard maintained (3SE03-DM1)	▶ 3SE03-AM1		▶ 3SE03-BM1		
		Low torqued momentary (3SE03-DL1)	▶ 3SE03-AL1 ^②		3SE03-BL1 ^②		
	Plain side plunger	Momentary (3SE03-DS1)	▶ 3SE03-AS1		▶ 3SE03-BS1		
	Roller side plunger	Momentary (3SE03-DS3)	▶ 3SE03-AS3		3SE03-BS3		
	Two-sided plunger	Maintained (3SE03-DH1)	3SE03-AH1		3SE03-BH1		
	Plain top plunger	Momentary (3SE03-DT1)	▶ 3SE03-AT1		3SE03-BT1		
	Roller top plunger	Momentary (3SE03-DT3)	3SE03-AT3		▶ 3SE03-BT3		
	Wobble head (without lever)	Momentary (3SE03-DW1)	▶ 3SE03-AW1		▶ 3SE03-BW1		

	Plug-In module type	Center neutral Double pole 2 NO + 2 NC (3SE03-SN)		
	Receptacle type surface mount	Center neutral (3SE03-RB) 		
Operating head type		Composite catalog number consisting of head, module and receptacle		
		DT	Catalog Number	List Price \$ 1 unit
	Side rotary (momentary)	Center (3SE03-DN1)	▶ 3SE03-NN1 ^①	
		Neutral (3SE03-DN2)	▶ 3SE03-NN2 ^②	

① 5° pretravel to operate contacts.



② 15° pretravel to operate contacts.





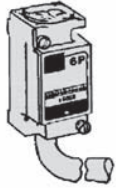

Limit Switches

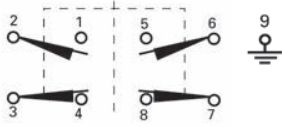
3SE03 Heavy Duty Limit Switches

NEMA type 6P submersible, prewired cable

Complete switches without lever - prewired cable:

 <p>Switch body type—prewired cable with 8 foot cable</p>	<p>Single pole 1 NO + 1 NC (3SE03-SA6P)</p> <p>Cable color code 1 - White 2 - Black 3 - Red 4 - Orange 5 - Green</p>	<p>Double pole 2 NO + 2 NC (3SE03-SB6P)</p> <p>Cable color code 1 - White 6 - Pink 2 - Black 7 - Yellow 3 - Red 8 - Blue 4 - Orange 9 - Green 5 - Brown</p>
		

Operating head type		Composite catalog number consisting of head and switch body				
		DT	Catalog Number	List Price \$ 1 unit	Catalog Number	List Price \$ 1 unit
 <p>Side rotary CW and CCW operation convertible to CW only or CCW only</p>	Standard momentary (3SE03-DR1)	▶	3SE03-AR16P		3SE03-BR16P	
	Standard maintained (3SE03-DM1)		3SE03-AM16P		3SE03-BM16P	
	Low torqued momentary (3SE03-DL1)		3SE03-AL16P		3SE03-BL16P	
 <p>Plain side plunger</p>	Momentary (3SE03-DS1)		3SE03-AS16P		3SE03-BS16P	
 <p>Roller side plunger</p>	Momentary (3SE03-DS3)		3SE03-AS36P		3SE03-BS36P	
 <p>Two-sided plunger</p>	Maintained (3SE03-DH1)		3SE03-AH16P		Not available	
 <p>Plain top plunger</p>	Momentary (3SE03-DT1)		3SE03-AT16P		3SE03-BT16P	
 <p>Roller top plunger</p>	Momentary (3SE03-DT3)		3SE03-AT36P		3SE03-BT36P	
 <p>Wobble head (without lever)</p>	Momentary (3SE03-DW1)		3SE03-AW16P		3SE03-BW16P	





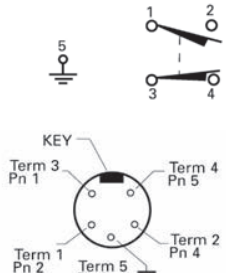
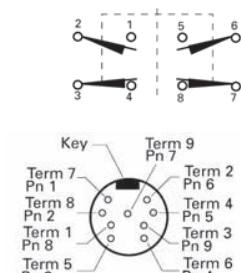

Limit Switches

3SE03 Heavy Duty Limit Switches

NEMA type 6P submersible, prewired receptacle

Complete switches without lever - prewired receptacle with pin connector:

 <p>Switch Body Type—prewired receptacle with pin connector</p>	<p>Single pole 1 NO + 1 NC (3SE03-SA6PC)</p> 	<p>Double pole 2 NO + 2 NC (3SE03-SB6PC)</p> 
--	---	--



Operating head type		Composite catalog number consisting of head and switch body				
		DT	Catalog Number	List Price \$ 1 unit	Catalog Number	List Price \$ 1 unit
 <p>Side rotary CW and CCW operation convertible to CW only or CCW only</p>	Standard momentary (3SE03-DR1)	▶	3SE03-AR16PC		3SE03-BR16PC	
	Standard maintained (3SE03-DM1)		3SE03-AM16PC		3SE03-BM16PC	
	Low torqued momentary (3SE03-DL1)		3SE03-AL16PC		3SE03-BL16PC	
 <p>Plain side plunger</p>	Momentary (3SE03-DS1)		3SE03-AS16PC		3SE03-BS16PC	
 <p>Roller side plunger</p>	Momentary (3SE03-DS3)		Not available		3SE03-BS36PC	
 <p>Two-sided plunger</p>	Maintained (3SE03-DH1)		3SE03-AH16PC		3SE03-BH16PC	
 <p>Plain top plunger</p>	Momentary (3SE03-DT1)		3SE03-AT16PC		3SE03-BT16PC	
 <p>Roller top plunger</p>	Momentary (3SE03-DT3)		3SE03-AT36PC		3SE03-BT36PC	
 <p>Wobble head (without lever)</p>	Momentary (3SE03-DW1)		3SE03-AW16PC		3SE03-BW16PC	

Limit Switches



3SE03 Heavy Duty Limit Switches

Modular, plug-in and NEMA type 6P submersible









Components:

 Plug-in module	Plug-in module	DT	Catalog Number	List Price \$ 1 unit
	Standard single pole 1 NO + 1 NC	▶	3SE03-SA	
	Standard double pole 2 NO + 2 NC	▶	3SE03-SB	
	Center neutral 2 NO + 2 NC ^①	▶	3SE03-SN	
 Receptacle	Receptacle for plug-in module		Catalog Number	List Price \$ 1 unit
	Single pole 1 NO + 1 NC (5 terminals)	▶	3SE03-RA	
	Single pole 2 NO + 2 NC (9 terminals)		3SE03-RB	

Switch body—NEMA type 6P submersible:

 Prewired cable	Switch body	Prewired cable 8 foot length			Prewired receptacle with pin connector		
		DT	Catalog Number	List Price \$ 1 unit	DT	Catalog Number	List Price \$ 1 unit
	Single pole 1 NO + 1 NC	▶	3SE03-SA6P				
	Single pole 2 NO + 2 NC	▶	3SE03-SB6P				
	 Prewired receptacle	Single pole 1 NO + 1 NC		—	—	▶	3SE03-SA6PC
Single pole 2 NO + 2 NC			—	—	▶	3SE03-SB6PC	

Operating heads^②:

		Nominal operating data								
Operating head type		Total travel	Pretravel	Operating force	Release position	Minimum return force	Operating temp range^⑦	DT	Catalog Number	List Price \$ 1 unit
 Side rotary^③	Standard momentary ^④	90°	5°	3 lb-in.	2°	4.5 oz-in.	1	▶	3SE03-DR1	
	Low torqued momentary ^④	90°	15°	1.5 lb-in.	6°	2.5 oz-in.	1	▶	3SE03-DL1	
	Standard maintained	90°	50°	3 lb-in.	50°	—	—	2	▶	3SE03-DM1
 Plain side plunger	Momentary	0.25 in.	0.065 in.	4 lbs	0.03 in.	8 oz.	2	▶	3SE03-DS1	
 Roller side plunger	Momentary ^②	0.25 in.	0.065 in.	4 lbs	0.03 in.	8 oz.	2	▶	3SE03-DS3	
 Two-sided plunger	Maintained	0.32 in.	0.2 in.	5 lbs	0.13 in.	5 lbs	2	▶	3SE03-DH1	
 Plain top plunger	Momentary	0.28 in.	0.04 in.	4 lbs	0.02 in.	8 oz.	3	▶	3SE03-DT1	
 Roller top plunger	Momentary	0.28 in.	0.04 in.	4 lbs	0.02 in.	8 oz.	3	▶	3SE03-DT3	
 Wobble head^{⑤⑧}	Momentary	15°	10°	2 lb-in.	6°	2.4 oz-in.	3	▶	3SE03-DW1	
 Center neutral^{⑥⑨}	Momentary	90°	5°	1.8 lb-in.	2°	2.5 oz-in.	2	▶	3SE03-DN1	
		90°	15°	1.8 lb-in.	2°	2.5 oz-in.	2	▶	3SE03-DN2	

① For use with 3SE03-DN1, -DN2 operating heads and 3SE03-RB receptacle only.

② For use with modular, Plug-in and NEMA Type 6P.

③

④ Refer to "Operating Temperature", Catalog page 13/118 for Temperature Ranges.

⑤ Without Operating Levers.

⑥ CW and CCW operation. Convertible to CW or CCW operation only.

⑦ Convertible—Horizontal to Vertical.

⑧ Requires Lever.





⑨ For use with 3SE03-SN plug-in module only.

Limit Switches

3SE03 Heavy Duty Limit Switches

Modular, plug-in metal housing

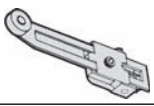
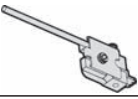
Levers for plug-in and non-plug-in versions—most widely used

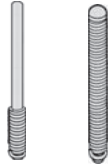
Description	Length ^①	Roller mounted on side of lever	Roller material	Roller diameter	Roller face width	Max required ^② return torque (oz-in.)	DT	Catalog Number	List Price \$ 1 unit
	1.5 (38)	Front	Nylatron	0.75 (19)	0.31 (8)	0.53	▶	3SX03-KL200	
	1.5 (38)	Front	Cast aluminum	0.75 (19)	0.31 (8)	1.10	▶	3SX03-KL355	
	1.5 (38)	Back	Cast aluminum	0.75 (19)	0.31 (8)	1.10	▶	3SX03-KL579	
	1.5 (38)	Back / back	Nylatron	0.75 (19)	0.31	-	▶	3SX03-KL204	
	1-3.5 (25-89)	Front	Nylatron	0.75 (19)	0.31 (8)	1.90 ^⑤	▶	3SX03-KL201	
	1-3.5 (25-89)	Front	Metal	0.75 (19)	0.31 (8)	3.40 ^⑤	▶	3SX03-KL538	
	9 (229)	-	Stainless steel	-	-	7.00 ^⑤	▶	3SX03-KL220	
	Adjustable spring rod	12.125 (308)	-	Nylon	-	-	3.50 ^⑤	▶	3SX03-KL556
	6 (152)	-	Nylatron	-	-	0.40	▶	3SX03-KL142	
Levers									
	Rod	-	Nylon	-	-	-	▶	3SX03-KW2	
	Coil spring	-	Coil spring	-	-	-	▶	3SX03-KW4	
	For plunger actuated switches wobble actuators	⑥							

Levers for plug-in and non-plug-in versions:

Operator	Length ^①	Roller			Max required ^② return torque (oz-in.)	Catalog Number			List Price \$ 1 unit
		Type	Diameter	Face (width)		Stainless steel	DT	Cast aluminum	
	1.37 (35)	Metal	0.75 (19)	0.31 (8)	0.95	-	▶	3SX03-KL40	
	1.50 (38)	Nylatron	0.75 (19)	1.00 (25)	0.92	-	▶	3SX03-KL337	
		Ball bearing	0.69 (17)	0.25 (6)	0.77	-	▶	3SX03-KL531	
		Without roller	-	-	0.32	-	▶	3SX03-KL32	
	2.00 (51)	Nylatron	0.75 (19)	0.31 (8)	0.71	-	▶	3SX03-KL546	
		Nylatron	0.75 (19)	1.00 (25)	1.45	-	▶	3SX03-KL572	
		Metal	0.75 (19)	0.31 (8)	1.5	-	▶	3SX03-KL549	
		Ball bearing	0.69 (17)	0.25 (6)	1.1	-	▶	3SX03-KL552	
	250 (64)	Nylatron	0.75 (19)	0.31 (8)	1.0	-	▶	3SX03-KL547	
Nylatron		0.75 (19)	1.00 (25)	1.8	-	▶	3SX03-KL573		
Nylatron		1.5 (38)	0.28 (7)	1.4	-	▶	3SX03-KL575		
Metal		0.75 (19)	0.31 (8)	2.0	-	▶	3SX03-KL550		
Ball bearing		0.69 (17)	0.25 (6)	1.5	-	▶	3SX03-KL553		
Cast aluminum	3.00 (76)	Nylatron	0.75 (19)	0.31 (8)	1.3	-	▶	3SX03-KL548	
		Nylatron	0.75 (19)	1.00 (25)	2.3	-	▶	3SX03-KL574	
		Nylatron	1.5 (38)	0.28 (7)	1.8	-	▶	3SX03-KL576	
		Metal	0.75 (19)	0.31 (8)	2.5	-	▶	3SX03-KL551	
		Ball bearing	0.69 (17)	0.25 (6)	1.8	-	▶	3SX03-KL554	

All dimensions shown in inches and (millimeters). For reference purposes only. Not to be used for design or construction purposes.

- ① Roller lever: Length from the operating shaft axis to the roller axis.
All other: Length from the operating shaft axis to the tip.

② Caution—When selecting lever, required return torque should not exceed minimum return torque in operating head.







- ③ Cap screw accommodates 3/64 inch Allen wrench.
④ By re-assembling lever minimum can be reduced another 0.50 (13).

- ⑤ Applies when lever extended to maximum dimension.
⑥ See dimensions page 13/76.





3SE03 Heavy Duty Limit Switches

Modular, plug-in and NEMA type 6P submersible

Levers for plug-in and non-plug-in versions—most widely used

Operator	Length ^① Inches (mm)	Roller			Min. required return torque oz-in. ^⑤	Catalog Number				
		Type	Diameter In. (mm)	Face width in. (mm)		DT	Stainless steel	Cast aluminum	List Price \$ 1 unit	
Roller levers										
	Roller on reverse side	1.50 (38)	Nylatron	0.75 (19)	0.31 (8)	0.53	▶	–	3SX03-KL310	
			Nylatron	1.5 (38)	0.28 (7)	0.96	▶	–	3SX03-KL536	
			Ball bearing	0.69 (17)	0.25 (6)	0.77	▶	–	3SX03-KL580	
	Offset lever (Inboard roller shown)	1.50 (38)	Nylatron	0.75 (19)	0.31 (8)	0.65	▶	3SX03-KL24	–	
			Metal	0.75 (19)	0.31 (8)	1.20	▶	3SX03-KL25	–	
		1.50 (38)	Nylatron	0.75 (19)	0.31 (8)	0.65	▶	3SX03-KL27	–	
			Metal	0.75 (19)	0.31 (8)	1.20	▶	3SX03-KL28	–	
			Ball bearing	0.69 (17)	0.25 (6)	0.90	▶	3SX03-KL29	–	
			Nylatron	0.75 (19)	1 (25)	1.10	▶	3SX03-KL30	–	
	Bantam lever	0.69 (18)	Metal	0.88 (22)	0.19 (5)	0.45	▶	3SX03-KL532		
	Precision adjustment	1.50 (38) ^②	Nylatron	0.75 (19)	0.31 (8)	0.65		3SX03-KL340		
			Metal	0.75 (19)	0.31 (8)	1.20		3SX03-KL465		
			Ball bearing	0.69 (17)	0.25 (6)	0.90	▶	3SX03-KL535		
	Adjustable roller	1–3.75 (25–95) ^③ 1–3.75 (25–95) ^③ 1.62–3.75 (41–95) ^③ 0.50–3.75 (13–95) 1–3.75 (25–95) ^③ 0.50–3.75 (13–95)	Nylatron	0.75 (19)	0.5 (13)	1.90 ^④	▶	3SX03-KL599		
			Nylatron	0.75 (19)	1 (25)	3.10 ^④	▶	3SX03-KL537		
			Nylatron	1.5 (38)	0.28 (7)	2.50 ^④	▶	3SX03-KL443		
			Large nylatron	4 (102)	0.11 (3)	4.50 ^④	▶	3SX03-KL598		
			Ball bearing	0.69 (17)	0.25 (6)	2.50 ^④	▶	3SX03-KL539		
			Without roller	–	–	1.20 ^④	▶	3SX03-KL31		
	Fork lever _ both rollers one side	1.50 (38)	Nylatron	0.75 (19)	1 (25)	–	▶	3SX03-KL543		
			Metal	0.75 (19)	0.31 (8)	–	▶	3SX03-KL544		
			Ball bearing	0.69 (17)	0.25 (6)	–	▶	3SX03-KL545		
	Fork lever _ both rollers outside, one side	1.50 (38)	Nylatron	0.75 (19)	0.31 (8)	–	▶	3SX03-KL203		
			Metal	0.75 (19)	0.31 (8)	–		3SX03-KL541		
			Ball bearing	0.69 (17)	0.25 (6)	–		3SX03-KL542		

Levers for plug-in and non-plug-in versions:

Operator		Length ^① Inches (mm)	Description Inches (mm)	Min. required return force oz-in. ^⑤	DT	Catalog Number	List Price \$ 1 unit
	Adjustable rod	5.50 (140) Max.	Nylon Rod—0.19 (5) Dia.	0.40 ^④	▶	3SX03-KL399	
		5.50 (140) Max.	Metal Rod—0.12 (3) Dia.	0.92 ^④	▶	3SX03-KL202	
		8.75 (222) Max.	Metal Rod (Square)—0.12 (3) Max.	2.20 ^④	▶	3SX03-KL581	
		12 (305) Max.	Steel (Formable) Rod—0.12 (3) Dia.	5.00 ^④	▶	3SX03-KL226	
		–	Clamp Only—0.19 (5) Hole	–	▶	3SX03-KL35	
		–	Clamp Only—0.12 (3) Hole	–		3SX03-KL36	
	Spring rod	11.62 (295)	Metal rod	2.80		3SX03-KL421	
	Adjustable wire	12.12 (308) max.	Nylon covered wire	1.50 ^④	▶	3SX03-KL533	
	Adjustable wide roller lever	3.9 (99)	0.75 (19) Dia. Nylatron Roller 0.19 (30) Dia. Rod	4.50 ^④	▶	3SX03-KL37	
Wobble head operators							
See dimensions page 13/76	Stainless steel rod	–	Rod diameter - 0.06 (2)	–	▶	3SX03-KW3	

① Length from operating shaft axis to the roller axis.

② Maximum dimensions, precision adjustable to lesser dimensions.

③ By re-assembling lever minimum can be reduced by 1/2 in.

④ Applies when lever extended to maximum dimension.

⑤ Caution—When selecting lever, required return torque should not exceed minimum return force in operating head.

All dimensions shown in inches and (millimeters). For reference purposes only. Not to be used for design or construction purposes.

Limit Switches

3SE03 Heavy Duty Limit Switches

Modular, plug-in and NEMA type 6P submersible

Wiring diagrams

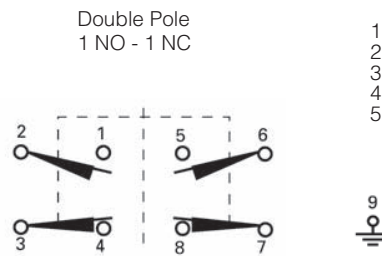
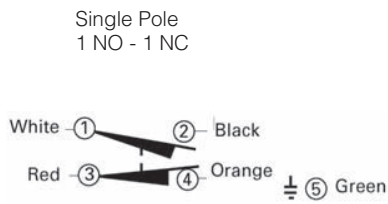

- Cable color code
- 1 - White 6 - Pink
 - 2 - Black 7 - Yellow
 - 3 - Red 8 - Blue
 - 4 - Orange 9 - Green
 - 5 - Brown
- Pre-wired cable

Modular, plug-in and prewired cable

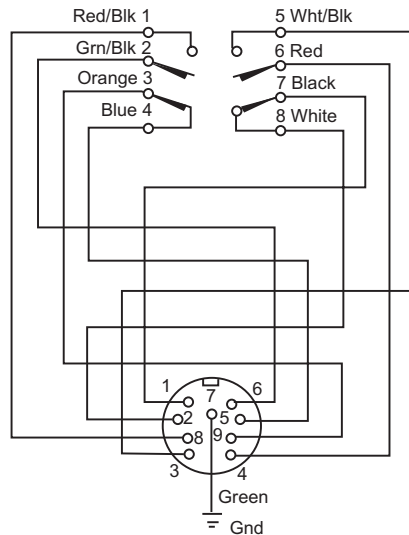
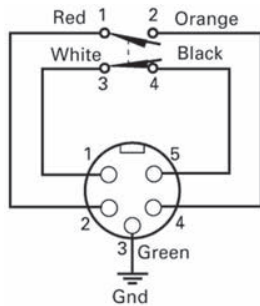

Prewired receptacle with pin connector

Typical connector cable (supplied by user)

Cable length ft.	Manufacturers part number			
	Daniel Woodhead Brad Harrison	Cooper Crouse-Hinds	Molex (Industrial Interface)	Lumberg USA
5 Pin connector cable				
3	105000A01F030	5000111-3_	14541	RK50-77/1M
6	105000A01F060	5000111-4_	14542	RK50-77/2M
12	105000A01F120	5000111-5_	14544	RK50-77/4M
9 Pin connector cable				
3	309000A01F030	X8990-3	-	-
6	309000A01F060	X8990-4	-	-
12	309000A01F120	X8990-5	-	-

3SE03 Heavy Duty Limit Switches

Modular, plug-in and NEMA type 6P submersible

Dimension drawings

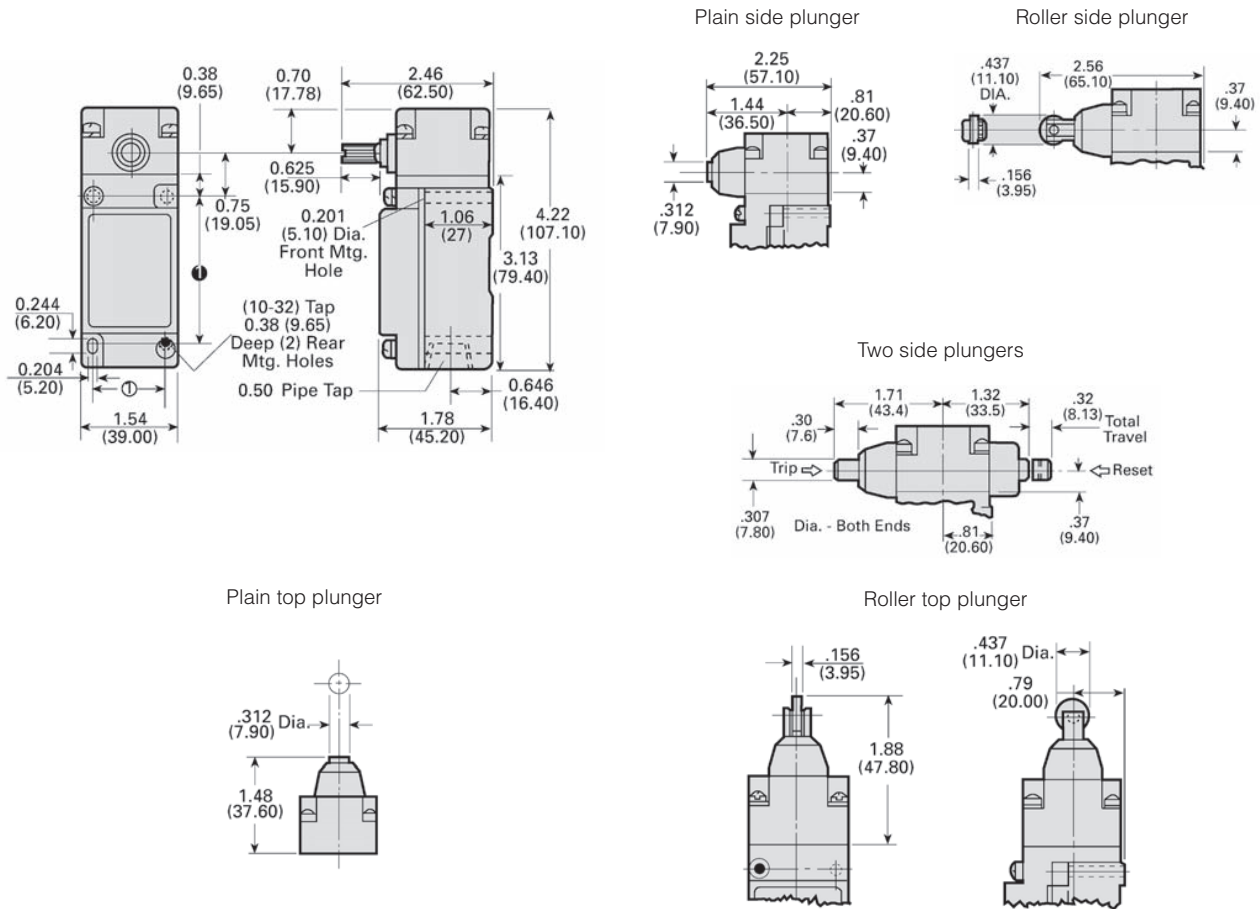

Rotary lever operators

	Dimensions						Catalog Number	Dimensions						
	A	B	C	D	E	F		A	B	C	D	E	F	
	3SX03-KL200	1.50 (38.1)	0.75 (19.0)	0.32 (8.1)	0.44 (11.2)	0.20 (5.1)	0.24 (6.1)	3SX03-KL554	3.00 (76.2)	0.688 (17.5)	0.25 (6.4)	0.42 (10.7)	0.12 (3.0)	0.18 (4.6)
	3SX03-KL355	1.50 (38.1)	0.75 (19.0)	0.32 (8.1)	0.44 (11.2)	0.20 (5.1)	0.24 (6.1)	3SX03-KL572	2.00 (50.8)	0.75 (19.0)	1.00 (25.4)	0.42 (10.7)	0.90 (22.9)	0.90 (22.9)
	3SX03-KL531	1.50 (38.1)	0.688 (17.5)	0.25 (6.4)	0.44 (11.2)	0.12 (3.0)	0.18 (4.6)	3SX03-KL573	2.50 (63.5)	0.75 (19.0)	1.00 (25.4)	0.42 (10.7)	0.90 (22.9)	0.90 (22.9)
	3SX03-KL546	2.00 (50.8)	0.75 (19.0)	0.32 (8.1)	0.42 (10.7)	0.20 (5.1)	0.24 (6.1)	3SX03-KL574	3.00 (76.2)	0.75 (19.0)	1.00 (25.4)	0.42 (10.7)	0.90 (22.9)	0.90 (22.9)
	3SX03-KL547	2.50 (63.5)	0.75 (19.0)	0.32 (8.1)	0.42 (10.7)	0.20 (5.1)	0.24 (6.1)	3SX03-KL575	2.50 (63.5)	1.50 (38.1)	0.29 (7.4)	0.42 (10.7)	0.18 (4.6)	0.24 (6.1)
	3SX03-KL548	3.00 (76.2)	0.75 (19.0)	0.32 (8.1)	0.42 (10.7)	0.20 (5.1)	0.24 (6.1)	3SX03-KL576	3.00 (76.2)	1.50 (38.1)	0.29 (7.4)	0.42 (10.7)	0.18 (4.6)	0.24 (6.1)
	3SX03-KL549	2.00 (50.8)	0.75 (19.0)	0.32 (8.1)	0.42 (10.7)	0.20 (5.1)	0.24 (6.1)	With rollers on reverse side						
	3SX03-KL550	2.50 (63.5)	0.75 (19.0)	0.32 (8.1)	0.42 (10.7)	0.20 (5.1)	0.24 (6.1)	3SX03-KL310	1.50 (38.1)	0.75 (19.0)	0.32 (8.1)	0.44 (11.2)	0.34 (8.6)	0.38 (9.7)
	3SX03-KL551	3.00 (76.2)	0.75 (19.0)	0.32 (8.1)	0.42 (10.7)	0.20 (5.1)	0.24 (6.1)	3SX03-KL536	1.50 (38.1)	1.50 (38.1)	0.28 (7.1)	0.44 (11.2)	0.30 (7.6)	0.38 (9.7)
	3SX03-KL552	2.00 (50.8)	0.688 (17.5)	0.25 (6.4)	0.42 (10.7)	0.12 (3.0)	0.18 (4.6)	3SX03-KL579	1.50 (38.1)	0.75 (19.0)	0.32 (8.1)	0.44 (11.2)	0.34 (8.6)	0.38 (9.7)
3SX03-KL553	2.50 (63.5)	0.688 (17.5)	0.25 (6.4)	0.42 (10.7)	0.12 (3.0)	0.18 (4.6)	3SX03-KL580	1.50 (38.1)	0.688 (17.5)	0.25 (6.4)	0.44 (11.2)	0.25 (6.4)	0.31 (7.9)	

All dimensions shown in inches and (millimeters). For reference purpose only. Not to be used for design or construction purposes.

© Can accommodate both U.S. 1.16 (29.4) x 2.34 (59.5) and DIN 1.18 (30.0) x 2.36 (60.0) mounting dimensions.

Limit Switches

3SE03 Heavy Duty Limit Switches

Modular, plug-in and NEMA type 6P submersible

Dimension drawings

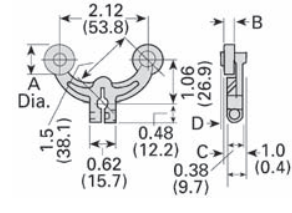
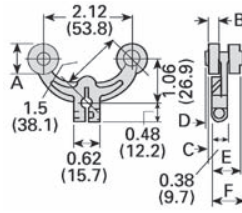
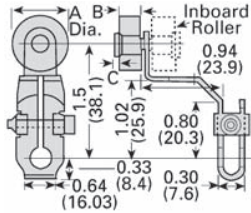

Offset roller levers

Catalog Number	Dimensions		
	A	B	C
Outboard roller			
3SX03-KL27	0.75 (19)	0.32 (8)	0.03 (1)
3SX03-KL28	0.75 (19)	0.32 (8)	0.03 (1)
3SX03-KL29	0.69 (18)	0.25 (6)	0.04 (1)
3SX03-KL30	0.75 (19)	1.0 (25)	-
Inboard roller			
3SX03-KL24	0.75 (19)	0.32 (8)	0.03 (1)
3SX03-KL25	0.75 (19)	0.32 (8)	0.03 (1)

Fork lever, one roller inside, one roller outside

Catalog Number	Dimensions					
	A	B	C	D	E	F
3SX03-KL203	0.75 (19)	0.32 (8)	0.16 (4)	0.20 (5)	0.73 (19)	0.77 (20)
3SX03-KL541	0.75 (19)	0.32 (8)	0.16 (4)	0.20 (5)	0.73 (19)	0.77 (20)
3SX03-KL542	0.69 (18)	0.25 (6)	0.08 (2)	0.14 (4)	0.64 (16)	0.70 (18)

Fork lever - Both rollers on one side

Catalog Number	Dimensions			
	A	B	C	D
3SX03-KL204	0.75 (19)	0.32 (8)	0.16 (4)	0.20 (5)
3SX03-KL543	0.75 (19)	1.0 (25)	0.86 (22)	0.86 (22)
3SX03-KL544	0.75 (19)	0.32 (8)	0.16 (4)	0.20 (5)
3SX03-KL545	0.69 (18)	0.25 (6)	0.08 (2)	0.1 (3)

Bantam roller lever

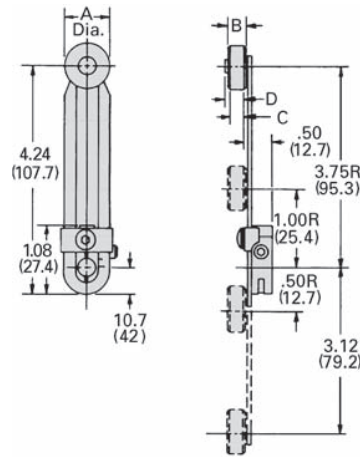
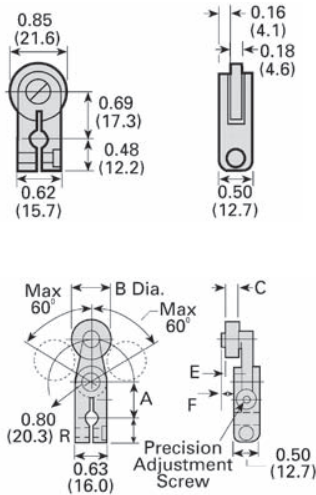

Precision adjustment roller lever

Catalog Number	Dimensions					
	A	B	C	D	E	F
3SX03-KL340	0.69 (18)	0.75 (19)	0.32 (8)	0.48 (12)	0.24 (6)	0.28 (7)
3SX03-KL465	0.69 (18)	0.75 (19)	0.32 (8)	0.48 (12)	0.24 (6)	0.28 (7)
3SX03-KL535	0.69 (18)	0.69 (18)	0.25 (6)	0.48 (12)	0.16 (4)	0.22 (6)

Adjustable roller lever

Catalog Number	Dimensions			
	A	B	C	D
3SX03-KL201	0.75 (19)	0.32 (8)	0.29 (7)	0.33 (8)
3SX03-KL443	1.5 (38)	0.29 (7)	0.26 (7)	0.32 (8)
3SX03-KL537	0.75 (19)	0.32 (8)	0.29 (7)	0.33 (8)
3SX03-KL538	0.69 (18)	0.25 (6)	0.21 (5)	0.27 (7)
3SX03-KL539	0.69 (18)	0.25 (6)	0.21 (5)	0.27 (7)
3SX03-KL598	0.39 (10)	0.11 (3)	0.11 (3)	0.19 (5)
3SX03-KL599	0.75 (19)	0.5 (13)	0.46 (12)	0.47 (12)

All dimensions shown in inches and (millimeters). For reference purposes only. Not to be used for design or construction purposes.

Limit Switches

3SE03 Heavy Duty Limit Switches

Modular, plug-in and NEMA type 6P submersible

Dimension drawings

Nylon Spring Rod Actuator
3SX03-KL556

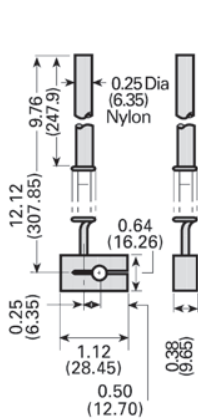

Nylon Covered Wire Actuator
3SX03-KL533

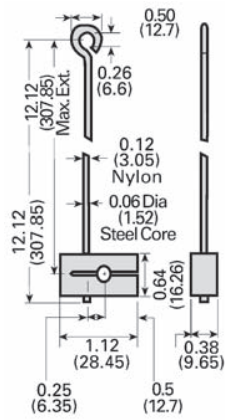

Stainless Steel Spring Actuator
3SX03-KL421

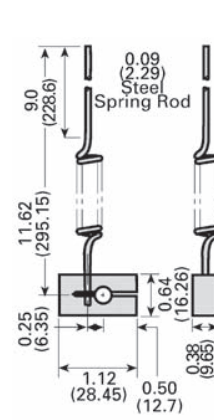

Adjustable Rod Actuator

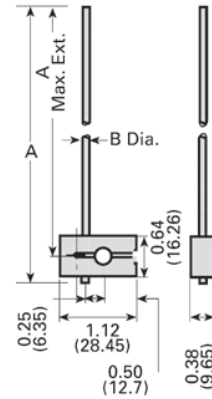

Adjustable Wire Roller Actuator
3SX03-KL37

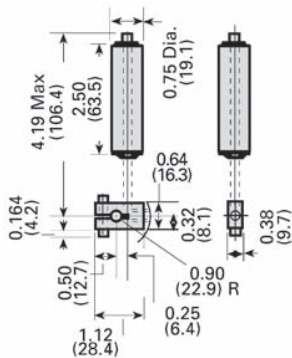

Nylatron Loop Actuator
3SX03-KL142

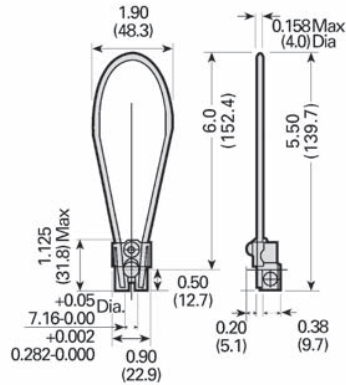

Adjustable rod actuators

Catalog Number	Material	Dimensions	
		A	B
3SX03-KL202	Steel-Round	5.50 (140)	0.120 (3)
3SX03-KL581	Steel-Square	8.75 (222)	0.125 (3)
3SX03-KL399	Nylon	5.50 (140)	0.190 (5)
3SX03-KL220	Stainless Steel	9.00 (229)	0.190 (5)
3SX03-KL226	Plated Steel	12.0 (305)	0.120 (3)

Wobble head with nylon head
3SE03-DW1
3SX03-KW2

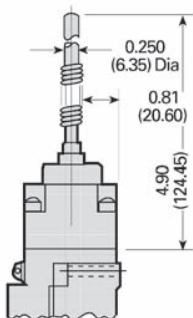

Wobble head with coil spring
3SE03-DW1
3SX03-KW4

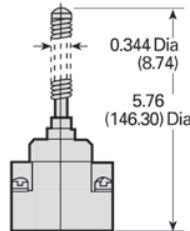

Wobble head with stainless steel rod
3SE03-DW1
3SX03-KW3

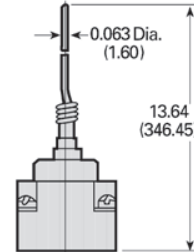

All dimensions shown in inches and (millimeters). For reference purposes only. Not to be used for design or construction purposes.

3SE03 Precision Limit Switches

3SE03 Metal enclosure

Description

Features

- NEMA 1 Enclosed Aluminum Die Cast Housing
- Screw Terminals
- Booted versions for added protection
- 1/2" Conduit Entrance
- NEMA A600, R300 Contacts
- UL Recognized
- CSA Certified
- INO/INC Snap-action contacts (form c)

Application

These switches are designed for accurate repeatability. Their compact size makes them ideal for use in space-restricted areas.

Typical applications include overhead, folding and elevator doors, sliding gates and other automated equipment.

Overall dimensions	Specifications ①	DT	Catalog Number	List Price \$ 1 unit
Plunger actuator	OF Max. - 8.82 - 12.3 oz. (250 - 350 g) RF Min. 4.02 oz. (114 g) PT Max. - 0.016 in. (0.4 mm) OT Min. - 0.217 in. (5.5 mm) MD Max. - 0.002 in. (0.05 mm) OP - 1.504 in. (38.2 mm)	▶	3SE03 - EB05	
Booted plunger	OF Max. - 28.22 oz. (800 g) RF Min. 8.46 oz. (240 g) PT Max. - 0.079 in. (2.0 mm) OT Min. - 0.197 in. (5.0 mm) MD Max. - 0.004 in. (0.1 mm) OP - 1.803 in. (45.8 mm)	▶	3SE03 - EB06	
Roller lever	OF Max. - 20.1 oz. (570 g) RF Min. 6.0 oz. (170 g) PT Max. - 0.157 in. (4.0 mm) OT Min. - 0.236 in. (6.0 mm) MD Max. - 0.016 in. (0.4 mm)	▶	3SE03 - EB32	
Booted roller lever	OF Max. - 22.57 oz. (640 g) RF Min. 8.11 oz. (230 g) PT Max. - 0.197 in. (5.0 mm) OT Min. - 0.236 in. (6.0 mm) MD Max. - 0.016 in. (0.4 mm)	▶	3SE03 - EB33	

① OF = Operating Force
 RF = Return Force
 PT = Pretravel
 OT = Operating Travel
 MD = Movement Differential
 OP = Operating Position

Dimension drawings

Overall dimensions	Specifications	DT	Catalog Number	List Price \$ 1 unit
<p>Roller plunger</p>	<p>OF Max. - 9.92 - 12.3 oz. (250 - 350 g) RF Min. 4.02 oz. (114 g) PT Max. - 0.02 in. (0.5 mm) OT Min. - 0.142 in. (3.6 mm) MD Max. - 0.002 in. (0.05 mm) OP - 1.957 in. (49.7 mm)</p>	▶	3SE03 - EB07	
<p>Booted roller plunger</p>	<p>OF Max. - 17.64 oz. (500 g) RF Min. 3.53 oz. (100 g) PT Max. - 0.039 in. (1.0 mm) OT Min. - 0.138 in. (3.5 mm) MD Max. - 0.006 in. (0.12 mm) OP - 1.957 in. (49.7 mm)</p>	▶	3SE03 - EB08	

Technical data								
Mechanical Life	3,000,000 operations maximum							
Electrical Life	500,000 operations minimum							
Operating Speed	0.01 m/second to 1m/second							
Cable Entry	1/2" NPT							
Temperature Range	-15° to 80° (5° to 176°F)							
Degree of Protection	NEMA 1							
Mounting	Any Position							
NEMA Rating	A600, R300							
Rated Voltage (V) ¹⁾²⁾	Non-Inductive Load (A)			Inductive load (A)			Inrush current (A)	
	Resistive load		Lamp load	Inductive load		Motor load		
	NC-NO	NO	NC	NC-NO	NO	NC	NO	NC
125 VAC	15	3	1.5	15	5	2.5	30 maximum	15 maximum
250 VAC	15	2.5	1.25	15	3	1.5		
500 VAC	3	1.5	0.75	2.5	1.5	0.75		
8 VDC	15	3	1.5	15	5	2.5		
14 VDC	15	3	1.5	10	5	2.5		
30 VDC	6 (2)	3	1.5	5	5	2.5		
125 VDC	0.4	0.4	0.4	0.05	0.05	0.05		
250 VDC	0.2	0.2	0.2	0.03	0.03	0.03		

1) Inductive load has power factor of 0.04 minimum (AC) and a time of 7m/second (DC)

2) Lamp load has an inrush current of 6 times steady-state current.

Overview



3SE7 cable-operated switches

More information

Industry Mall, see www.siemens.com/product?3SE7

For Manual, see <https://support.industry.siemens.com/cs/ww/en/view/107194954>

The cable-operated switches are used for monitoring or as EMERGENCY STOP devices on particularly endangered system components.

As the effective range of a cable-operated switch is only limited by the length of the trip-wire, large systems can also be protected. Cable-operated switches (requiring pulling at both ends) and conveyor belt unbalance trackers are used primarily for monitoring very long belt systems.

Contact blocks

The switches for wire lengths up to 50 m are supplied with 1 NO + 1 NC or 2 NC contacts and those up to 75 m with 1 NO + 3 NC contacts. The switches for wire lengths of 2 x 75 m and the conveyor belt unbalance tracker are supplied with 2 NO + 2 NC contacts.

The NC contacts of the cable-break or cable-pull signaling are positive opening. The NO contact can be used, for example, for signaling purposes.

Free position and display

Cable-operated switches with one-side operation are held in free position by the pre-tension on the turnbuckle.

On switches with interlocking, with a pre-tensioned cable, the locking must be deactivated beforehand in order to return the cable-operated switch to its original position.

The cable-operated switch and the conveyor belt unbalance tracker can be supplied optionally with a factory-fitted LED (red, 24 V DC). This light in innovative chip-on-board technology allows the operating state of the switch to be visible at a distance of at least 50 m.

Application

Standards

The switches are equipped with latching mechanism and positive NC contacts and are thus suitable for operation in EMERGENCY STOP devices according to EN ISO 13850.

Technical specifications

Type	3SE7120	3SE7150	3SE7140	3SE7141	3SE7160	3SE7310	
General data							
Standards	IEC/EN 60947-5-1 IEC/EN 60204-1, EN ISO 13850						
Approvals	UL/CSA						
Electrical design	Contacts electrically isolated from each other						
Electrical load							
• 2-pole, at AC-15	400 V AC, 6 A		400 V AC, 6 A	240 V AC, 2 A	400 V AC, 6 A	--	
• 3-pole, at AC-15	240 V AC, 2 A		--	--	--	--	
• 4-pole, at AC-15	--		--	--	400 V AC, 6 A	400 V AC, 6 A	
• Minimum	24 V AC/DC, 10 mA						
Short-circuit protection	A	6 (slow)					
Mechanical endurance	> 100 000 operating cycles						
Contact material	Fine silver						
Operation	By pulling or breaking of wire						
Wire length, maximum	m	10	25	50	75	2 x 100	--
Distance between wire supports, max.	m	3		5		4	--
Enclosures							
Enclosure material	GD Al alloy, coated (color), dark black RAL 9005						
Cover	Shock-resistant thermoplast						
Degree of protection acc. to IEC 60529 ¹⁾	IP65			IP67		IP65	
Ambient temperature	°C	-25 ... +70					
Mounting	Designed for M5						
Fixing spacing	mm	30 and 40					
Cable entry	2 x (M20 x 1.5)		1 x (M20 x 1.5)	3 x (M20 x 1.5)	2 x (M25 x 1.5)		
Connection type	Screw terminals M3.5, self-lifting clamp terminal						

¹⁾ IP54 for versions with key-operated release

Selection and ordering data

Version	Wire length	Contacts	SD	Article No.	Price per PU	PU (UNIT, SET, M)	PS*	
	m		d					
Cable-operated switches								
 <p>3SE7120-1BH00</p>	Metal enclosures, IP65 (cover made of molded plastic)	10						
		<ul style="list-style-type: none"> • Without latching, only cable pull monitoring 	1 NO + 1 NC	↻	2	3SE7120-2DD01	1	1 unit
		<ul style="list-style-type: none"> • With latching and button reset 	2 NC	↻	2	3SE7120-1BF00	1	1 unit
		<ul style="list-style-type: none"> - With yellow cover 	1 NO + 2 NC	↻	2	3SE7120-1BH00	1	1 unit
 <p>3SE7150-1BD00</p>	Metal enclosures, IP65 (cover made of molded plastic), with alignment window	25						
		<ul style="list-style-type: none"> • Without latching 	1 NO + 1 NC	↻	2	3SE7150-2DD00	1	1 unit
		<ul style="list-style-type: none"> • With latching and button reset 	1 NO + 1 NC	↻	2	3SE7150-1BD00	1	1 unit
			2 NC	↻	2	3SE7150-1BF00	1	1 unit
		<ul style="list-style-type: none"> - With yellow cover 	1 NO + 2 NC	↻	5	3SE7150-1BH00	1	1 unit
<ul style="list-style-type: none"> • With latching and key unlatching 	1 NO + 1 NC	↻	5	3SE7150-1CD00	1	1 unit		
 <p>3SE7150-1BD04 3SE7150-1BH04</p>	Metal enclosures, IP65 (cover made of molded plastic), with alignment window, with LED, red, 24 V DC	25						
		<ul style="list-style-type: none"> • Without latching 	1 NO + 1 NC	↻	5	3SE7150-2DD04	1	1 unit
		<ul style="list-style-type: none"> • With latching and button reset 	1 NO + 1 NC	↻	5	3SE7150-1BD04	1	1 unit
		<ul style="list-style-type: none"> • With yellow cover 	1 NO + 2 NC	↻	5	3SE7150-1BH04	1	1 unit
 <p>3SE7140-1B.00</p>	Metal enclosures, IP65 (cover made of molded plastic)	50						
		<ul style="list-style-type: none"> • With latching and button reset 	1 NO + 1 NC	↻	2	3SE7140-1BD00	1	1 unit
			2 NC	↻	5	3SE7140-1BF00	1	1 unit
		<ul style="list-style-type: none"> • In addition with LED, red, 24 V DC 	1 NO + 1 NC	↻	5	3SE7140-1BD04	1	1 unit
		<ul style="list-style-type: none"> • With latching and key unlatching 	1 NO + 1 NC	↻	5	3SE7140-1CD00	1	1 unit
 <p>3SE7141-1EG10</p>	Metal enclosures, IP67 (cover made of molded plastic), with EMERGENCY STOP mushroom, with rotate-to-unlatch mechanism	75	1 NO + 3 NC	↻	2	3SE7141-1EG10	1	1 unit
 <p>3SE7160-1AE00</p>	Metal enclosures, IP65 With actuation on both sides	2 x 100						
		<ul style="list-style-type: none"> • With latching and button reset 	2 NO + 2 NC	↻	2	3SE7160-1AE00	1	1 unit
			1 NO + 1 NC	↻	5	3SE7160-1BD00	1	1 unit
		<ul style="list-style-type: none"> • In addition with LED, red, 24 V DC 	2 NO + 2 NC	↻	5	3SE7160-1AE04	1	1 unit

↻ Positive opening according to IEC 60947-5-1, Annex K.

SIRIUS 3SE7 Cable-Operated Switches

3SE7 metal enclosures

Version	Contacts	SD	Article No.	Price per PU	PU (UNIT, SET, M)	PS*
		d				

Conveyor belt unbalance trackers



Metal enclosures, IP65

- With latching and button reset
- In addition with LED, red, 24 V DC

2 NO + 2 NC	⊕	5
2 NO + 2 NC	⊖	5

3SE7310-1AE00	1	1 unit
3SE7310-1AE04	1	1 unit

3SE7310-1AE00

⊕ Positive opening according to IEC 60947-5-1, Annex K.

Accessories

Configuration of the cable-operated switches

Short lengths of wire up to 25 m

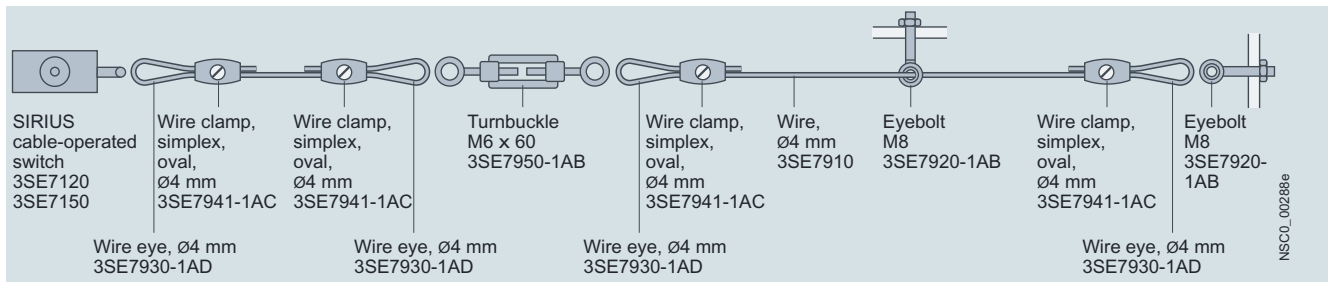

Long lengths of wire up to 50 m

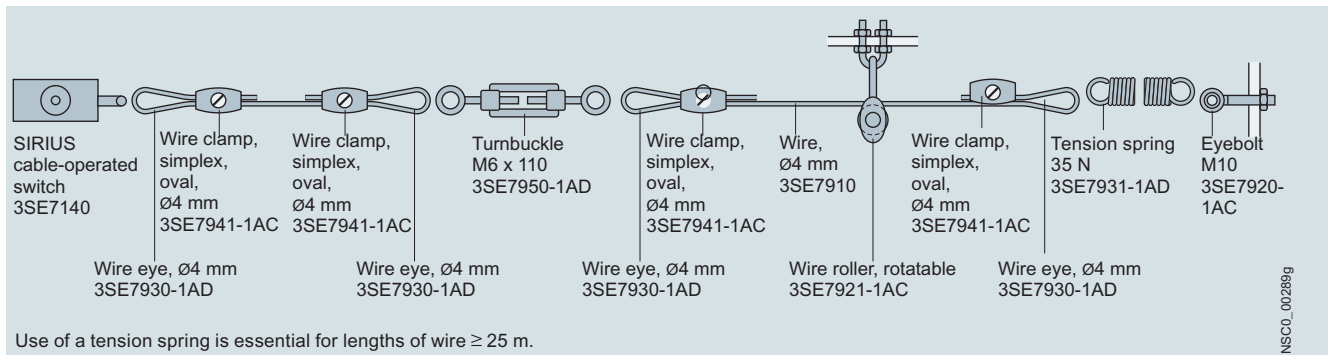

Pulling from both sides up to 2 x 100 m

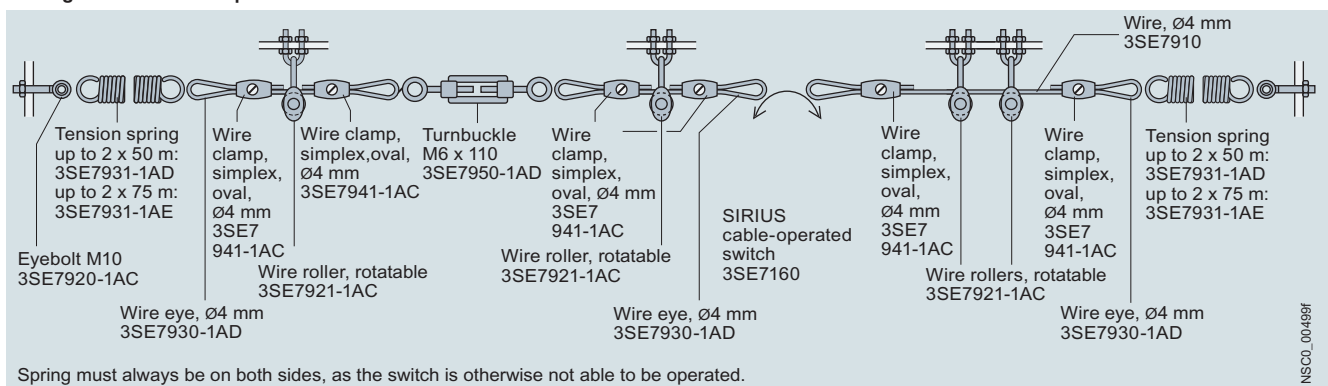

Note:

Large temperature fluctuations require corresponding compensation springs. For reliable connection the PVC sheath must be removed from the clamping area of the

steel bowden wire. Bowden wire supports must be used at the recommended intervals.

Version	Length/ diameter	SD	Article No.	Price per PU	PU (UNIT, SET, M)	PS*
Trip-wire with fixing						
 3SE7910-3AA	Steel wires , with red plastic sheath, diameter 4 mm ¹⁾	10 m	2	3SE7910-3AA	1	1 unit
		15 m	2	3SE7910-3AB	1	1 unit
		20 m	2	3SE7910-3AC	1	1 unit
		50 m	2	3SE7910-3AH	1	1 unit
 3SE7941-1AC  3SE7942-1AA  3SE7943-1AC  3SE7944-1AC	Wire clamps , galvanized white, zinc-plated					
	• Oval	2 x Ø 4 mm	2	3SE7941-1AC	1	1 unit
	• Single (1 set = 4 units)	2 x Ø 4 mm	2	3SE7942-1AA	1	4 units
	• Simplex (1 set = 4 units)	2 x Ø 4 mm	2	3SE7943-1AC	1	4 units
	• Duplex (1 set = 4 units)	2 x Ø 4 mm	2	3SE7944-1AC	1	4 units
 3SE7931-1AB	Tension springs (zinc-plated) to maintain the counter tension					
	• 13 N		2	3SE7931-1AB	1	1 unit
	• 35 N, for cable-operated switches up to 50 m		2	3SE7931-1AD	1	1 unit
	• > 35 N, for cable-operated switches up to 2 x 75 m		5	3SE7931-1AE	1	1 unit
 3SE7921-1AC	Wire rollers for changing the direction of the wire, rotatable	Ø 4 mm	2	3SE7921-1AC	1	1 unit
	Fixtures for the wire rollers (incl. fixing nuts)		2	3SE7921-1AA	1	1 unit
 3SE7921-1AA  3SE7930-1AD	Wire eyes for changes in wire direction and improved power transmission at the fixing points (1 set = 4 units)	Ø 4 mm	2	3SE7930-1AD	1	4 units
	Eyebolts for fixing the wire					
 3SE7920-1AB	• Including M8 nut		2	3SE7920-1AB	1	1 unit
	• Including M10 nut		2	3SE7920-1AC	1	1 unit
 3SE7950-1AB	Turnbuckles for precise adjustment of the pre-tension					
	• M6 x 60		2	3SE7950-1AB	1	1 unit
	• M6 x 110		2	3SE7950-1AD	1	1 unit
Spare parts						
 3SX3235	LED lamps , red 24 V DC diameter 25 mm; for M20 x 1.5 connection		10	3SX3235	1	1 unit

¹⁾ Diameter including casing; the diameter of the steel wire is 3.2 mm.

Overview

Equipment

The two-hand operation consoles are pre-equipped with commanding devices. In the case of plastic enclosures the command points are equipped as standard with actuators and indicators made of plastic and in the case of metal enclosures they are equipped with actuators and indicators made of metal.

The standard equipment comprises:

- 2 black mushroom pushbuttons, diameter 40 mm, 1 NO + 1 NC
- 1 red EMERGENCY STOP mushroom pushbutton according to ISO 13850, diameter 40 mm, with positive latching, 2 NC

The plastic version can be retrofitted with up to 8 customized command points. The surface of the console has premachined breaking points for this purpose.

Application

The two-hand operation consoles are required for use with machines and systems that have hazardous areas, in order to direct both hands of the operator to one position.

The operation consoles are primarily used on presses, stamping machines, printing presses and paper converting machines, in the chemical industry and in the rubber and plastics industries.

The control command is given by pressing the two mushroom pushbuttons on the sides simultaneously (within 0.5 s of each other) and must be maintained for as long as a hazard exists.

For the further processing of control commands, evaluation units are used, e.g. 3SK11 safety relays or the 3RK3, 3SK2 Modular Safety System.

Standards

The two-hand operation consoles comply with the requirements of EN 574.

Selection and ordering data

Version of actuating element/ unlatching method/ operating principle	Color of actuating element	Number of NO contacts	NC contacts	SD d	Article No.	Price per PU	PU (UNIT, SET, M)	PS*
--	----------------------------------	-----------------------------	----------------	---------	-------------	-----------------	-------------------------	-----

Two-hand operation consoles

Plastic



3SU1803-3NB00-1AE1

None	--	0	0	5	3SU1803-3AA00-0AA1		1	1 unit
A = Mushroom pushbutton/ momentary contact B = EMERGENCY STOP mushroom pushbutton/ rotate to unlatch C = Mushroom pushbutton/ momentary contact	A = Black/ B = Red/ C = Black	2	4	5	3SU1803-3NB00-1AE1		1	1 unit

Metal



3SU1853-3AA00-0AA1

None	--	0	0	5	3SU1853-3AA00-0AA1		1	1 unit
------	----	---	---	---	---------------------------	--	---	--------



3SU1853-3NB00-1AA1

A = Mushroom pushbutton/ momentary contact B = EMERGENCY STOP mushroom pushbutton/ rotate to unlatch C = Mushroom pushbutton/ momentary contact	A = Black/ B = Red/ C = Black	2	4	5	3SU1853-3NB00-1AA1		1	1 unit
---	-------------------------------------	---	---	---	---------------------------	--	---	--------



3SU1853-3NB00-1AD1

		2	4	5	3SU1853-3NB00-1AD1		1	1 unit
--	--	---	---	---	---------------------------	--	---	--------

Version	Material	Color	SD d	Article No.	Price per PU	PU (UNIT, SET, M)	PS*
---------	----------	-------	---------	-------------	-----------------	-------------------------	-----

Accessories

Stands for two-hand operation consoles



3SU1950-0HN10-0AA0

	Metal	Black	5	3SU1950-0HN10-0AA0		1	1 unit
--	-------	-------	---	---------------------------	--	---	--------

Overview



SIRIUS 3SK safety relays

More information

Homepage, see www.usa.siemens.com/safety-relays
 Industry Mall, see www.siemens.com/product?3SK
 Conversion tool, e.g. from 3TK28 to 3SK, see www.siemens.com/sirius/conversion-tool

SIRIUS 3SK safety relays are the key elements of a consistent, cost-effective safety chain. Whether you need EMERGENCY STOP functionality, protective door monitoring, light arrays, laser scanners or the protection of presses or punches – slimline SIRIUS safety relays enable all safety applications to be implemented in the best possible way in terms of engineering and price.

The following safety-related functions are available:

- Monitoring the safety functions of sensors
- Monitoring the sensor leads
- Monitoring the correct device function of the safety relay
- Monitoring the actuators in the shutdown circuit
- Safety-related disconnection when dangers arise

SIRIUS 3SK safety relays are approved for applications up to SIL 3 (IEC 61508/IEC 62061) or PL e (EN ISO 13849-1).

Device series

SIRIUS 3SK safety relays stand out due to their flexibility for both parameterization and system designs with several evaluation units. This reduces device variance, thus bringing advantages in terms of device selection and spare parts management. Optimized solutions when selecting components and reduced spare part inventory requirements are facilitated by a clearly structured component range:

The following device series are available:

- 3SK1 Standard basic units
- 3SK1 Advanced basic units
- 3SK2 basic units
- 3SK1 output expansions
- 3SK1 input expansions
- Accessories

3SK1 Standard basic units

The 3SK1 Standard basic units are characterized by the following features:

- Compact design
- Simple operation
- Relay and semiconductor outputs
- Economical solution

3SK1 Advanced basic units

The 3SK1 Advanced basic units also offer:

- Universal application possibilities thanks to multifunctionality
- Time-delayed outputs
- Expansion of inputs and outputs

3SK2 basic units

The 3SK2 basic units also offer:

- Up to six fail-safe, independent shutdown functions
- Flexible in use thanks to software parameterization
- Powerful semiconductor outputs
- Convenient diagnostics using diagnostics display and configuration software

In the case of 3SK1 Advanced basic units or 3SK2 basic units, the 3ZY12 device connector allows safety functions involving several sensors and actuators to be constructed very quickly.

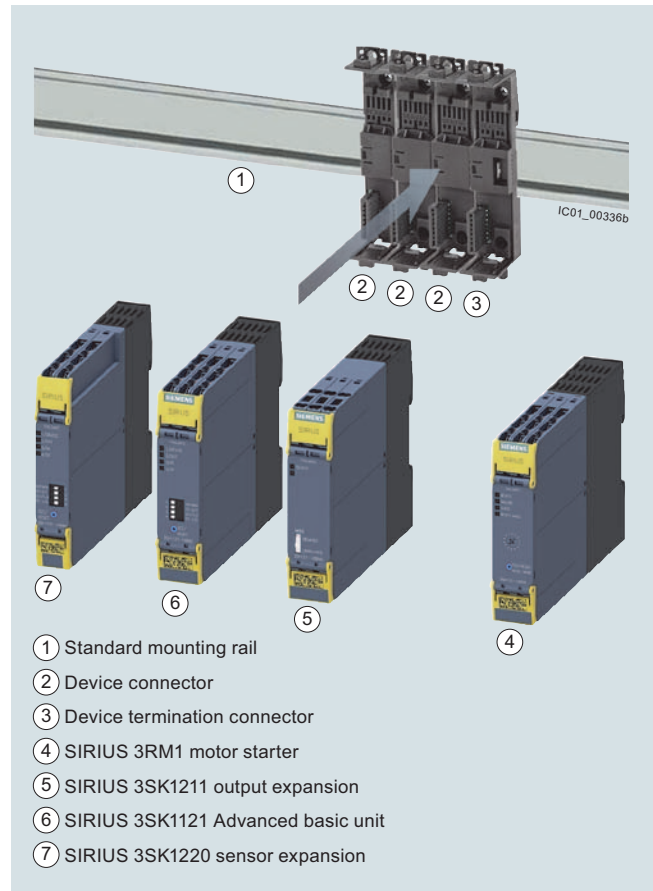

System configuration example

General data

The 3SK1 Standard and Advanced and 3SK2 series are a high-quality replacement for the 3TK28 safety relays. In their narrower design, and equipped with greater functionality, they

can replace every 3TK28 device. The only exception to this are the 3TK2810 devices.

Overview of functions of the 3SK series

Type	3SK1 Standard basic units		3SK1 Advanced basic units		3SK2 basic units	
	Safe relay outputs	Safe semiconductor outputs	Safe relay outputs	Safe semiconductor outputs	22.5 mm	45 mm
					Safe semiconductor outputs	Safe semiconductor outputs
Sensors						
• Mechanical	✓	✓	✓	✓	✓	✓
• Non-floating	✓ ¹⁾	✓	✓	✓	✓	✓
• Antivalent	--	--	✓	✓	✓	✓
• Expandable	--	✓ by means of cascading	✓	✓	--	--
Inputs						
	2 x single-channel, 1 x two-channel	2 x single-channel, 1 x two-channel	2 x single-channel, 1 x two-channel	2 x single-channel, 1 x two-channel	Freely configurable: 10 x single-channel, 5 x two-channel	Freely configurable: 20 x single-channel, 10 x two-channel
Parameters						
• Start (auto/monitored)	✓	✓	✓	✓	A variety of functions can be set for each input/output by means of software parameterization.	
• Sensor connection 2 x single-channel/ 1 x two-channel	✓ by means of wiring	✓	✓	✓		
• Cross-circuit detection	✓ by means of wiring	✓	✓	✓		
• Start test ON/OFF	--	✓	✓	✓		
• Monitoring of two-hand operation consoles according to EN 574	--	--	✓	✓		
• Pressure-sensitive mat	--	--	✓	✓		
Safe outputs						
• Instantaneous	✓	✓	✓	✓	Configurable	Configurable
• Time-delayed	--	--	✓	✓	Configurable	Configurable
• Expandable with safe relay outputs	✓ by means of wiring	✓ by means of wiring	✓	✓	✓	✓
• Independent	--	--	--	--	✓ ⁴⁾	✓ ⁵⁾
• Device connectors	--	--	✓	✓	✓	✓
Options						
• External memory module	--	--	--	--	--	✓
• Display on the device	--	--	--	--	--	✓
• External diagnostics module can be connected	--	--	--	--	✓	✓
Control supply voltage						
• 24 V DC	✓ ²⁾	✓	✓	✓	✓	✓
• 110 ... 240 V AC/DC	✓	✓ ⁶⁾	✓ ³⁾	✓ ³⁾	--	--

✓ Available
-- Not available

1) 24 V basic units only.
2) 24 V AC/DC.
3) Possible using 3SK1230 power supply via device connector.
4) Up to four independent safe outputs, two of which via device connectors.
5) Up to six independent safe outputs, two of which via device connectors.
6) Possible using 3SK1230 power supply by means of wiring.

SIRIUS 3SK Safety Relays

General data

Parameter assignment

3SK112 and 3SK1112 with DIP switch

The 3SK112 and 3SK1112 safety relays are configurable safety relays. They are used as evaluation units for typical safety chains (detect, evaluate, react). A number of functions can be set using the DIP switches on the front. 3SK112 and 3SK1112 are therefore universally applicable.

DIP switch No.	OFF	ON	Schematic
1	Sensor input Autostart	Sensor input Monitored start	
2	Without crossover monitoring	With crossover monitoring	
3	2 x single-channel sensor connection	1 x two-channel sensor connection	
4	With start test	Without start test	

3SK2 with software

The 3SK2 safety relays are configured with the SIRIUS Safety ES software. The behavior of a 3SK2 device as well as the functioning of the individual safe outputs can thus be parameterized simply and conveniently in the logic diagram. In addition, the configuration can be printed out for documentation purposes. The software also supports users in commissioning and troubleshooting by means of online diagnostics and the option of "forcing" signals in the logic diagram. The 3SK2 safety relays thus offer maximum flexibility and universal application options.

Note:

SIRIUS Safety ES, see page 13/162.

Enclosure concept

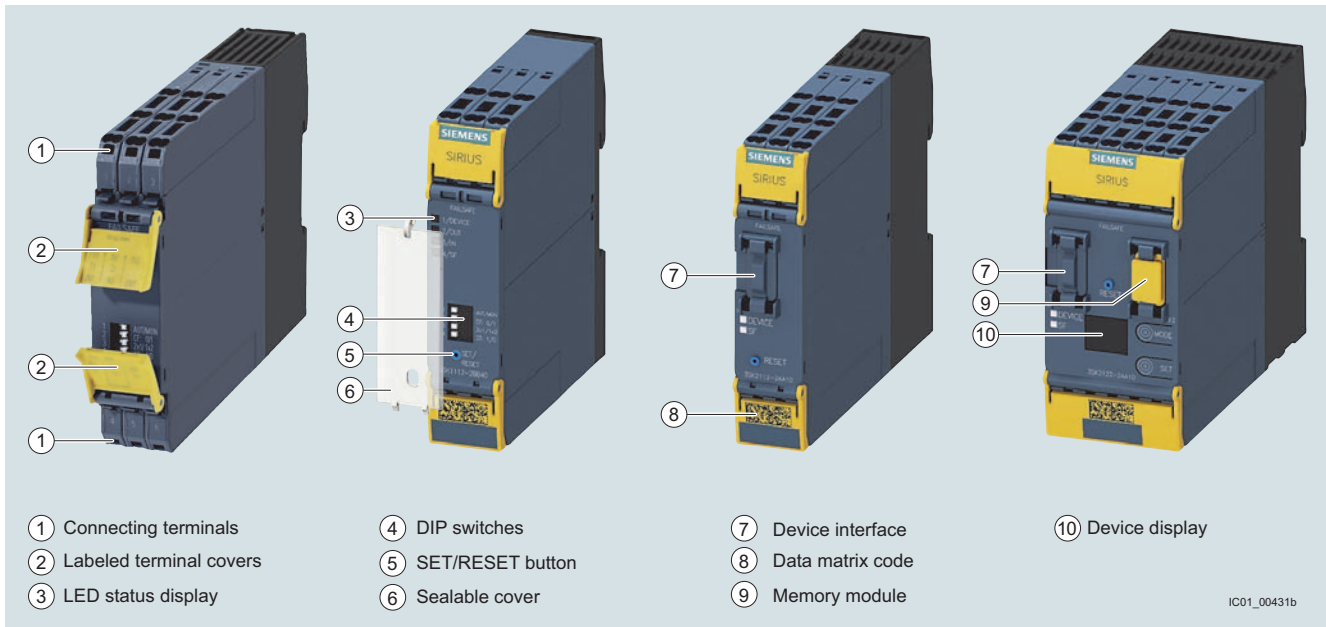

Innovative enclosure concept for SIRIUS 3SK safety relays

Connection methods

The 3SK safety relays are available with screw or spring-type terminals (push-in).

Spring-type terminals (push-in)

Push-in connections are a form of spring-type terminals allowing fast wiring without tools for rigid conductors or conductors equipped with end sleeves.

As with other spring-type terminals, a screwdriver (with 3.0 x 0.5 mm blade) is required to disconnect the conductor. The same tool can also be used to wire finely stranded or stranded conductors with no end finishing.

The advantages of the push-in terminals are found, as with all spring-type terminals, in speed of assembly and disassembly and vibration-proof connection. There is no need for the checking and tightening required with screw terminals.

Seamlessly integrated safety right through to the main circuit

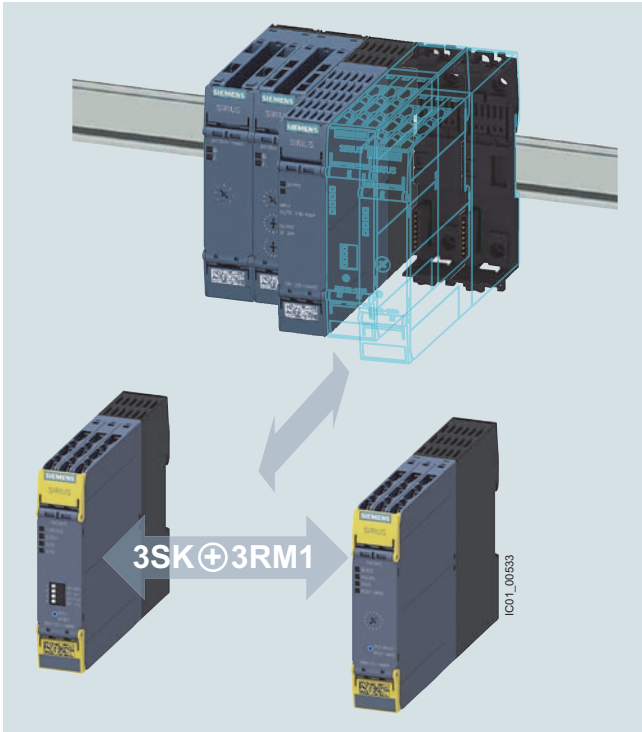

Functional safety in the main circuit needs to be both simple and flexible

The unique compatibility of hybrid 3RM1 fail-safe motor starters and 3SK safety relays means that integrated functional safety right through to the main circuit is no longer a problem.

Their compact design allows the motor starters to be installed to the right of the safety relay in a simple manner, just like an output expansion. The wiring of the safety-related signals to the relay can be performed simply, quickly and in an error-free manner using the device connector.

The ergonomically designed enclosure with removable terminals and terminal labeling in the hinged cover allows for the cables to be conveniently diagonally mounted from the front. Either screw or spring-type terminals with push-in technology are available.

Highlights

- Fail-safe disconnection of motors up to 3 kW
- Problem-free combination of fail-safe motor starters and safety relays
- End-to-end system, simple setup using device connectors
- Ergonomic enclosure

Note:

SIRIUS 3RM1 motor starters, [see Section 6](#).

Problem-free integration of functional safety into the main circuit through the simple combination of 3RM1 and 3SK1 devices

Article No. scheme

Product versions		Article number									
3SK1 safety relays		3SK1	<input type="checkbox"/>	<input type="checkbox"/>	<input type="checkbox"/>	<input type="checkbox"/>	<input type="checkbox"/>	<input type="checkbox"/>	<input type="checkbox"/>		
Device version	Basic unit	1									
	Expansion unit	2									
Device variants	3SK11: Standard; 3SK12: Output expansion	1									
	3SK11: Advanced; 3SK12: Input expansion	2									
Type of outputs	Relay outputs	1									
	Semiconductor outputs	2									
	Power outputs	3									
Connection type	Screw terminals					1					
	Spring-type terminals (push-in)					2					
Control circuit/actuation	3SK11: 3 enabling circuits							A			
	3SK11: 2 enabling circuits							B			
	3SK11: 4 enabling circuits							C			
Type of control supply voltage	3SK1213: 24 V AC, 50/60 Hz							B	0		
	3SK1: 24 V AC/DC, 50/60 Hz							B	3		
	3SK1: 24 V DC							B	4		
	3SK1213: 115 V AC, 50/60 Hz							J	2		
	3SK1213: 230 V AC, 50/60 Hz							L	2		
	3SK1: 110 ... 240 V AC/DC; 50/60 Hz							W	2		
Time delay	None								0		
	0.05 ... 3 s								1		
	0.5 ... 30 s								2		
	5 ... 300 s								4		
Example		3SK1	1	1	1	-	1	A	B	3	0

General data

Product versions		Article number									
3SK2 safety relays		3SK2	1	<input type="checkbox"/>	2	-	<input type="checkbox"/>	A	A	1	0
Device variants	10 F-DI, 2 F-DQ, width 22.5 mm		1								
	20 F-DI, 4 F-DQ, width 45 mm		2								
Connection type	Screw terminals							1			
	Spring-type terminals (push-in)							2			
Example		3SK2	1	1	2	-	1	A	A	1	0

Note:

The Article No. schemes show an overview of product versions for better understanding of the logic behind the article numbers.

For your orders, please use the article numbers quoted in the selection and ordering data.

Benefits

General

- Approved for all safety applications because of its compliance with the highest safety requirements (SIL 3 and PL e)
- Universally usable thanks to adjustable parameters
- Usable worldwide thanks to globally valid certificates
- Compact SIRIUS design
- Device connectors with standard rail mounting for flexible connectability and expandability
- Removable terminals for greater plant availability
- Yellow terminal covers clearly identify the device as a safety component
- Sensor cable up to 2 000 m long allows it to be used in extensive plants

Relay outputs

- Different voltages can be switched through the floating contacts
- The relay contacts allow currents of up to 5 A at AC-15/DC-13 to be connected

Semiconductor outputs

- Wear-free
- Suitable for operation in frequently switching applications
- Insensitive to vibrations and dirt
- Good electrical endurance

Power outputs (3SK1213 output expansion)

- Different voltages can be switched through the floating contacts
- With the power relay contacts currents up to 10 A AC-15/6 A DC-13 can be switched
- High mechanical and electrical endurance
- Protective separation between safe outputs and electronics

Expansion option by adding the 3RM1 motor starter

SIRIUS 3SK safety relays are ideal for combining with the SIRIUS 3RM1 motor starters.

Combinations are made by means of

- SIRIUS 3ZY12 device connectors (in combination with 3SK1 Advanced/3SK2) or
- Conventional wiring (for all 3SK1 and 3SK2 basic units)

This makes collective shutdown very easy in assemblies. The wiring, and ultimately the shutting down of the control supply voltage for the expansion components in EMERGENCY STOP situations, is performed via the device connector. There is no further need for complex looping of the connecting cables between the safety relay and the motor starters.

The 3RM1 motor starter combines the benefits of semiconductor technology and relay technology. This combination is also known as hybrid technology.

The hybrid technology in the motor starter is characterized by the following features:

- The inrush current in the case of motorized loads is conducted briefly via the semiconductors. Advantages include protection of the relay contacts and a long service life due to low wear.
- The uninterrupted current is conducted via relay contacts. Advantages include lower heat losses compared with the semiconductor.
- Shutdown is implemented again via the semiconductor. The contacts are only slightly exposed to arcs, and this results in a longer service life.
- Integrated overload protection

Note:

SIRIUS 3RM1 motor starters, see Section 6.

3ZY12 device connectors

Using 3ZY12 device connectors to combine devices reduces the time required to configure and wire the components. At the same time errors are avoided during wiring, and this considerably reduces the testing required for the fully-assembled application.

Configuration and stock keeping

Variable setting options by means of DIP switches or software, a wide voltage range (3SK111) and a special power supply unit (3SK1 only) reduce the cost of keeping stocks and the considerations involved in configuration where the evaluation units to be selected are concerned.

Application

3SK1 safety relays

SIRIUS 3SK1 safety relays are used mainly in autonomous safety applications which are not connected to a safety-related bus system. Their function here is to evaluate the sensors and the safety-related shutdown of hazards. Also they check and monitor the sensors, actuators and safety-related functions of the safety relay.

3SK2 safety relays

SIRIUS 3SK2 safety relays are used primarily in autonomous, more complex safety applications for which the functional scope of the 3SK1 devices is no longer sufficient, such as in the implementation of independent shutdown functions or integration into higher-level control systems for diagnostics via fieldbus. Their function here is to evaluate the sensors and the safety-related shutdown of hazards. Also they check and monitor the sensors, actuators and safety-related functions of the safety relay.

Technical specifications

More information	
Manual 3SK1, see https://support.industry.siemens.com/cs/ww/en/view/67585885	Manual 3SK2, see https://support.industry.siemens.com/cs/ww/en/view/109444336
Technical specifications 3SK1230, see https://support.industry.siemens.com/cs/ww/en/ps/16388/tid	FAQs, see https://support.industry.siemens.com/cs/ww/en/ps/16382/faq

SIRIUS 3SK1 safety relays

Article number	3SK1111- .AB30, 3SK1211- .BB00, 3SK1211- .BB40	3SK1111- .AW20, 3SK1121, 3SK1211- .BW20	3SK1112	3SK1120	3SK1122	3SK1213	3SK1220	
General data:								
Width x height x depth	mm		22.5 x 100 x 121.6	22.5 x 100 x 91.6	17.5 x 100 x 121.6	22.5 x 100 x 121.6	90 x 100 x 121.6	17.5 x 100 x 121.6
Ambient temperature	°C		-25 ... +60					
• During operation	°C		-40 ... +80					
• During storage								
Installation altitude at height above sea level, maximum	m		2 000					
Air pressure acc. to SN 31205	kPa		90 ... 106					
Shock resistance	10 g / 11 ms					5 g / 10 ms	10 g / 11 ms	
Vibration resistance according to IEC 60068-2-6	5 ... 500 Hz: 0.75 mm							
Degree of protection of the enclosure	IP20							
Touch protection against electric shock	Finger-safe							
Insulation voltage, rated value	V	300	50			300	50	
Impulse withstand voltage, rated value	V	4 000	800			4 000	800	
Safety integrity level (SIL) according to IEC 61508	3							
Performance level (PL) according to EN ISO 13849-1	e							
T1 value for proof test interval or service duration according to IEC 61508	20							
EMC emitted interference	IEC 60947-5-1, class B					IEC 60947-5-1, class A		
Certificate of suitability								
• UL certification	Yes							
• TÜV approval	Yes							

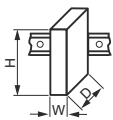

General data

Article number	3SK1111, 3SK1121-.AB40, 3SK1211	3SK1112, 3SK1122	3SK1120	3SK1121-.CB4.	3SK1213
Switching capacity current of the NO contacts of the relay outputs					
• At AC-15 at 230 V	A 5	--		3	10
• At DC-13 at 24 V	A 5	--		3	6
Switching capacity current of the semiconductor outputs at DC-13 at 24 V	A --	2	0.5	--	

Article number	3SK1111- .AB30, 3SK1211	3SK1111- .AW20	3SK1112, 3SK1220	3SK1120, 3SK1122- .AB40	3SK1121- .AB40	3SK1121- .CB4.	3SK1122- .CB4.	3SK1213
PFHD at high demand rate according to EN 62061	1/h 1.7×10^{-9}	1.5×10^{-9}	1.0×10^{-9}	1.3×10^{-9}	2.5×10^{-9}	3.7×10^{-9}	1.5×10^{-9}	1.0×10^{-9}
PFDavg at low demand rate according to IEC 61508	1.0×10^{-6}		7.0×10^{-6}					1.0×10^{-6}

SIRIUS 3SK2 safety relays

Article number	3SK2112- .AA10	3SK2122- .AA10
----------------	-------------------	-------------------

General data:

Width x height x depth	mm	22.5 x 100 x 124.5	45 x 100 x 124.5
-------------------------------	----	--------------------	------------------

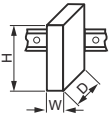

Ambient temperature			
• During operation	°C	-25 ... +60	
• During storage	°C	-40 ... +80	
Installation altitude at height above sea level, maximum	m	2 000	
Air pressure acc. to SN 31205	kPa	90 ... 106	
Shock resistance		15 g / 11 ms	
Vibration resistance acc. to IEC 60068-2-6		5 ... 500 Hz: 0.75 mm	
Degree of protection of the enclosure		IP20	
Touch protection against electric shock		Finger-safe	
Insulation voltage, rated value	V	50	
Impulse withstand voltage, rated value	V	800	
Safety integrity level (SIL) according to IEC 61508		3	
Performance level (PL) according to EN ISO 13849-1		e	
T1 value for proof test interval or service duration according to IEC 61508	y	20	
EMC emitted interference according to IEC 60947-1		Class A	
Certificate of suitability			
• UL certification		Yes	
• TÜV approval		Yes	
Switching capacity current of the semiconductor outputs at DC-13 at 24 V	A	4	
PFHD at high demand rate according to EN 62061	1/h	1.0×10^{-8}	1.2×10^{-8}
PFDavg at low demand rate according to IEC 61508		1.5×10^{-5}	1.8×10^{-5}

Safety Relays

SIRIUS 3SK Safety Relays, Basic Units

SIRIUS 3SK1 Standard basic units

Overview



3SK111 Standard basic units

The 3SK111 Standard basic units are characterized by simple, variable functionality. These devices are recommended for safety functions requiring only a few sensors and a small number of outputs on the safety relay.

Note:

Use of device connectors not possible.

Selection and ordering data



3SK1111-1AB30



3SK1111-1AW20



3SK1112-1BB40

Control supply voltage		Number of outputs			SD			Article No.	Price per PU	PU (UNIT, SET, M)	PS*
at AC at 50 Hz	at DC	as contacting contact block		as contactless semiconductor contact block							
V	V	as NO contact, instantaneous switching	as NO contact, delayed switching	for signaling function, instantaneous switching	instantaneous switching	delayed switching	for signaling function, instantaneous switching				
24	24	3	0	1	0	0	0	▶	3SK1111-□AB30	1	1 unit
110 ... 240	110 ... 240	3	0	1	0	0	0	1	3SK1111-□AW20	1	1 unit
--	24	0	0	0	2	0	1	2	3SK1112-□BB40	1	1 unit

Type of electrical connection

- Screw terminals
- Spring-type terminals (push-in)

1
2

Overview



3SK112 Advanced basic units

The 3SK112 Advanced basic units form an innovative system landscape that allows even complex safety functions with large numbers of sensors and outputs to be built up using the device connectors. It is possible to increase both the number of inputs for sensors and the number of safe outputs of the basic unit without the need for wiring outlay between the devices.

Note:

Use of device connectors possible.

Selection and ordering data



3SK1121-1AB40



3SK1120-1AB40



3SK1122-1AB40



3SK1122-1CB41

Control supply voltage at DC	Number of outputs as contacting contact block			as contactless semiconductor contact block			Adjustable OFF-delay time	SD	Article No.	Price per PU	PU (UNIT, SET, M)	PS*
	as NO contact, instantaneous switching	as NO contact, delayed switching	as NC contact for signaling function, instantaneous switching	instantaneous switching	delayed switching	for signaling function, instantaneous switching						
24	3	0	1	0	0	0	--	▶	3SK1121-□AB40		1	1 unit
	2	2	0	0	0	0	0.05 ... 3	2	3SK1121-□CB41		1	1 unit
							0.5 ... 30	1	3SK1121-□CB42		1	1 unit
							5 ... 300	5	3SK1121-□CB44		1	1 unit
24	0	0	0	1	0	0	--	2	3SK1120-□AB40		1	1 unit
				3	0	1	--	2	3SK1122-□AB40		1	1 unit
				2	2	0	0.05 ... 3	5	3SK1122-□CB41		1	1 unit
							0.5 ... 30	2	3SK1122-□CB42		1	1 unit
						5 ... 300	5	3SK1122-□CB44		1	1 unit	

Type of electrical connection

- Screw terminals
- Spring-type terminals (push-in)

1
2

Overview



3SK2 basic units

The 3SK2 basic units have a large number of inputs and outputs within a narrow width. In addition, demanding safety applications can be implemented simply with several independent safety functions. Flexible application options are enabled by powerful semiconductor outputs, as well as by expandability with additional 3SK output expansions and 3RM1 Failsafe motor starters. Flexible time functions and diagnostics options are available. The 22.5-mm-wide version of the 3SK2 basic units has 10 x single-channel (5 x two-channel) inputs, while the 45-mm-wide 3SK2 version comes with 20 x single-channel (10 x two-channel) inputs.



Starter Kit

Starter Kit

The Starter Kit is a favorably-priced complete package for the simple creation of complex safety applications and comprises:

- 3SK2112-2AA10 basic unit, 22.5 mm wide, with spring-type terminals (push-in)
- SIRIUS Safety ES Standard software for configuring, commissioning, operating and diagnosing
- USB PC cable for easy transmission of the configuration to the device by means of USB

Selection and ordering data



3SK2112



3SK2122

Control supply voltage at DC	Number of outputs as contactless semiconductor contact block, safety-related, two-channel	Number of outputs as contactless semiconductor contact block, non-safety-related, two-channel	Number of outputs to the device connector, safety-related	Width	SD	Article No.	Price per PU	PU (UNIT, SET, M)	PS*
V				mm	d				
3SK2 basic units									
24	2	1	2	22.5	2	3SK2112-□AA10		1	1 unit
	4	2	2	45	2	3SK2122-□AA10		1	1 unit

Type of electrical connection

- Screw terminals
- Spring-type terminals (push-in)



Control supply voltage at DC	Number of outputs as contactless semiconductor contact block, safety-related, two-channel	Number of outputs as contactless semiconductor contact block, non-safety-related, two-channel	Number of outputs to the device connector, safety-related	Width	SD	Spring-type terminals (push-in)	Article No.	Price per PU	PU (UNIT, SET, M)	PS*
V				mm	d	☐☐ ☐☐				
Starter Kit										
Contains 3SK2112-2AA10 basic unit, SIRIUS Safety ES Standard and 3UF7941-0AA00-0 USB PC cable										
24	2	1	2	22.5	2		3SK2941-2AA10		1	1 unit

Overview



3SK121 output expansion

The 3SK121 output expansions can be used to expand all 3SK basic units.

3SK1211 output expansion

The 3SK1211 output expansion is used to expand the safe outputs of a basic unit by adding another four safe outputs. These outputs have a switching capacity of AC-15 5 A at a switching voltage of 230 V. The devices can be connected to any 3SK basic unit by means of wiring. In addition, the devices with a 24 V DC control supply voltage can also be connected to 3SK1 Advanced basic units and 3SK2 basic units by means of the 3ZY12 device connectors.

3SK1213 output expansion

The 3SK1213 output expansion is used to expand the safe outputs of a basic unit by adding three safe outputs with high switching capacity. These outputs have a switching capacity of AC-15 10 A at a switching voltage of 230 V. The devices can be connected to any 3SK basic unit by means of wiring. As with the 3SK1211, the devices with a 24 V DC control supply voltage can also be connected to 3SK1 Advanced and 3SK2 basic units by means of the 3ZY12 device connectors.

Note:

It is only possible to expand the Standard basic units by means of wiring. Advanced basic units and 3SK2 basic units can be expanded using the 3ZY12 device connector.

Benefits

- Perfect adaptation of the number of outputs
- Simple expansion of instantaneous and time-delayed safe outputs of the Advanced basic units using device connectors
- When using the device connector the outputs on the terminals of the basic device can still be used
- Another two freely configurable shutdown functions on 3SK2 basic units when using device connectors
- Expansion with power contacts for high AC-15/DC-13 currents in the control circuit
- No wiring of the feedback circuit to the basic units is required when using device connectors
- Shorter installation times
- Less configuring and testing required

Selection and ordering data



3SK1211-1BB40



3SK1213-1AB40

Control supply voltage		Number of outputs as contacting contact block			3ZY12 device connectors	SD	Article No.	Price per PU	PU (UNIT, SET, M)	PS*
at AC at 50 Hz	at DC	as NO contact, instantaneous switching	as NO contact, delayed switching	as NC contact instantaneous switching for feedback circuit						
V	V									
24	--	4	0	1	No	5	3SK1211-□BB00		1	1 unit
--	24	4	0	1	Yes	1	3SK1211-□BB40		1	1 unit
110 ... 240	110 ... 240	4	0	1	No	2	3SK1211-□BW20		1	1 unit
--	24	3	0	1	Yes	5	3SK1213-□AB40		1	1 unit
115	--	3	0	1	No	5	3SK1213-□AJ20		1	1 unit
230	--	3	0	1	No	5	3SK1213-□AL20		1	1 unit

Type of electrical connection

- Screw terminals
- Spring-type terminals (push-in)

1
2

Overview



3SK1220 sensor expansion

With the input expansions

- 3SK1220 sensor expansion
- 3SK1230 power supply

the 3SK1 Advanced basic units can be made more flexible.

3SK1220 sensor expansion

The 3SK1220 input expansion allows additional sensors to be integrated easily and flexibly. The device monitors two single-channel sensors or one two-channel sensor, whatever their output technology (floating/single-ended).

Note:

The 3SK1220 sensor expansion can only be connected to the 3SK1 Advanced basic units by means of the 3ZY12 device connector, [see page 13/145](#).

3SK1230 power supply

The 3SK1230 power supply makes the 3SK1 devices universally usable, whatever control supply voltage is to be used.

Note:

Alongside the 3ZY12 device connector, the 3SK1230 power supply can also be wired to act as a power supply for 3SK1 devices.

Benefits

- A wide voltage range of 110 ... 240 V AC/DC allows the devices to be used worldwide
- Low stock keeping due to little variance
- Flexible expansion of the number of sensors without the need for additional wiring between the devices
- Perfect adaptation of the number of inputs to suit the application
- Universal use thanks to the wide range of adjustable parameters for sensor expansion (parameters as for 3SK1 Advanced basic units)

Selection and ordering data



3SK1220-1AB40



3SK1230-1AW20

Version	SD	Article No.	Price per PU	PU (UNIT, SET, M)	PS*
	d				
Sensor expansions					
For safety-related expansion of the 3SK1 Advanced basic units by adding a further two-channel sensor or two single-channel sensors	2	3SK1220-□AB40		1	1 unit
Power supply					
For supplying 3SK1 Advanced basic units via 3ZY12 device connectors at voltages of 110 ... 240 V AC/DC	2	3SK1230-□AW20		1	1 unit

Type of electrical connection

- Screw terminals
- Spring-type terminals (push-in)

1
2

Overview

Numerous accessories are available for 3SK, such as device connectors, terminals, cables, adapters, covers, memory and diagnostics modules or software.

Device connectors for 3SK112., 3SK12.. and 3SK2

The device connector can be used to connect devices of the 3SK/3RM1 system together, with the last device in a system configuration being placed on a device termination connector. Use of device connectors not possible with 3SK1 standard.

Device connectors are available in various versions specifically for the 3SK safety relays:

For type	Device connectors				Device termination connectors	
	3ZY1212-1BA00 (for 3SK1, width 17.5 mm)	3ZY1212-2BA00 (for 3SK1, width 22.5 mm)	3ZY1212-2GA00 (for 3SK2, width 22.5 mm)	3ZY1212-4GA01 (for 3SK2, width 45 mm)	3ZY1212-2DA00 (for 3SK1, width 22.5 mm)	3ZY1212-0FA01 (for 3SK1, set for enclosures ≥ 45 mm)
3SK1 Advanced basic units						
3SK1120	✓	--	--	--	--	--
3SK1121	--	✓	--	--	✓	--
3SK1122	--	✓	--	--	✓	--
3SK2 basic units						
3SK2112	--	--	✓	--	--	--
3SK2122	--	--	--	✓	--	--
Output expansions						
3SK1211	--	✓	--	--	✓	--
3SK1213	--	--	--	--	--	✓
Input expansions						
3SK1220	✓	--	--	--	--	--
3SK1230	--	✓	--	--	--	--

✓ Available
-- Not available

Removable terminals for 3SK

The following removable terminals are available for the 3SK safety relays for pre-wiring of the terminals in the control cabinet, or for replacing terminals:

For type	Removable terminals			
	Screw terminals		Spring-type terminals (push-in)	
	2-pole 3ZY1121-1BA00	3-pole 3ZY1131-1BA00	2-pole 3ZY1121-2BA00	3-pole 3ZY1131-2BA00
3SK1 basic units				
3SK1111	--	✓	--	✓
3SK1112	✓	--	✓	--
3SK1120	--	✓	--	✓
3SK1121	--	✓	--	✓
3SK1122	✓ bottom	✓ top	✓ bottom	✓ top
3SK2 basic units				
3SK2112	--	✓	--	✓
3SK2122	--	✓ ¹⁾	--	✓ ¹⁾
Output expansions				
3SK1211	✓	--	✓	--
3SK1213	--	--	--	--
Input expansions				
3SK1220	--	✓ top	--	✓ top
3SK1230	✓ bottom	--	✓ bottom	--

✓ Available
-- Not available
1) Two sets of terminals are required for 3SK2122.

Selection and ordering data

Version	SD	Article No.	Price per PU	PU (UNIT, SET, M)
	d			

Device connectors for the electrical connection of SIRIUS devices in the industrial standard mounting rail enclosure

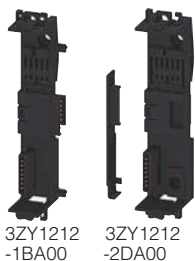

Device connector for 3SK1	SD	Article No.	Price per PU	PU (UNIT, SET, M)
• Width 17.5 mm	2	3ZY1212-1BA00		1
• Width 22.5 mm	2	3ZY1212-2BA00		1
Device connector for 3SK2				
• Width 22.5 mm	2	3ZY1212-2GA00		1
• Width 45 mm	2	3ZY1212-4GA01		1
Device termination connectors	2	3ZY1212-2DA00		1
For 3SK1, width 22.5 mm				
Note: Observe positions of the slide switch, see Manual "3SK1".				
Device daisy chain connectors	2	3ZY1212-2AB00		1
For 3RM1 and 3SK, 24 V DC, 22.5 mm, for implementation of distances between devices according to the installation guidelines				
Device connectors	2	3ZY1210-2AA00		1
For height adjustment for devices without electrical connection via device connector, with a width of 22.5 mm or greater				
Device termination connector set	2	3ZY1212-0FA01		1
For 3SK1213, width > 45 mm, comprising 3ZY1212-2FA00 and 3ZY1210-2AA00				

Version	SD	Article No.	Price per PU	PU (UNIT, SET, M)
---------	----	-------------	--------------	-------------------

Terminals for SIRIUS devices in the industrial standard mounting rail enclosure



3ZY1121-1BA00

Removable terminals

- 2-pole, up to 2 x 1.5 mm² or 1 x 2.5 mm²
- 3-pole, up to 2 x 1.5 mm² or 1 x 2.5 mm² ¹⁾

- 2-pole, up to 2 x 1.5 mm²
- 3-pole, up to 2 x 1.5 mm² ¹⁾

Screw terminals



- ▶ 2 **3ZY1121-1BA00**
- ▶ 2 **3ZY1131-1BA00**

Spring-type terminals (push-in)



- ▶ 2 **3ZY1121-2BA00**
- ▶ 2 **3ZY1131-2BA00**

PC cables and adapters for 3SK2 (essential accessories)



3UF7941-0AA00-0

USB PC cables

For connecting to the USB interface of a PC/PG, for communication with 3SK2 through the system interface, recommended for use in connection with 3SK2

- ▶ **3UF7941-0AA00-0**

Connecting cables for 3SK2 (essential accessory for diagnostics module)



3UF7932-0AA00-0

For connecting diagnostics module to 3SK2 basic unit

Central units with expansion modules	Diagnostics modules with central unit	Length
✓	✓	• 0.025 m (flat) ▶
--	✓	• 0.1 m (flat) ▶
--	✓	• 0.15 m (flat) NEW ▶
--	✓	• 0.3 m (flat) ▶
--	✓	• 0.5 m (flat) ▶
--	✓	• 0.5 m (round) ▶
--	✓	• 1.0 m (round) ▶
--	✓	• 2.5 m (round) ▶

- ▶ **3UF7930-0AA00-0**
- ▶ **3UF7931-0AA00-0**
- ▶ **3UF7934-0AA00-0**
- ▶ **3UF7935-0AA00-0**
- ▶ **3UF7932-0AA00-0**
- ▶ **3UF7932-0BA00-0**
- ▶ **3UF7937-0BA00-0**
- ▶ **3UF7933-0BA00-0**

Operating and monitoring modules for 3SK2



3SK2611-3AA00

Diagnostics modules

For direct display of errors, e.g. of cross-circuits

Note:

The 3RK3611-3AA00 MSS diagnostics module cannot be operated on the 3SK2 devices.

- ▶ 2 **3SK2611-3AA00**

Door adapters for 3SK2



3UF7920-0AA00-0

For external connection of the system interface, e.g. outside a control cabinet

- ▶ **3UF7920-0AA00-0**

Interface covers for 3SK2



3RA6936-0B

For system interface

- Titanium gray

▶ 10

- ▶ **3RA6936-0B**



3UF7950-0AA00-0

- Light gray

▶

- ▶ **3UF7950-0AA00-0**

Memory modules for 3SK2



3RK3931-0AA00

For backing up the complete parameterization of the 3SK2 safety system without a PC/PG through the system interface

▶ 2

- ▶ **3RK3931-0AA00**

Software for 3SK2









3ZS1316-.C.10-0Y.5

SIRIUS Safety ES

Software for configuring, commissioning, operating and diagnosing of 3SK2 and 3RK3, [see page 13/162](#).

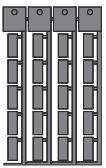
¹⁾ For 3SK2122 two terminal sets are required.

Version	SD	Article No.	Price per PU	PU (UNIT, SET, M)
Accessories for enclosures				
 3ZY1321-2AA00	Sealing covers			
	<ul style="list-style-type: none"> • 17.5 mm (for 3SK1120 and 3SK1220) • 22.5 mm (for all 3SK1 devices except 3SK1120 and 3SK1220) 	2	3ZY1321-1AA00	1
 3ZY1311-0AA00	Push-in lugs For wall mounting			
		2	3ZY1311-0AA00	1
 3ZY1440-1AA00	Coding pins For removable terminals of SIRIUS devices in the industrial standard mounting rail enclosure; they enable the mechanical coding of terminals, see Manual "3SK1"			
		2	3ZY1440-1AA00	1
 3ZY1450-1AB00 3ZY1450-1BB00	Hinged cover NEW Replacement cover, without terminal labeling			
	<ul style="list-style-type: none"> • Titanium gray <ul style="list-style-type: none"> - 22.5 mm wide (for 3SK1230) 	2	3ZY1450-1AB00	1
	<ul style="list-style-type: none"> • Yellow <ul style="list-style-type: none"> - 17.5 mm wide (for 3SK1220, 3SK1120) 	2	3ZY1450-1BA00	1
	<ul style="list-style-type: none"> - 22.5 mm wide (for 3SK11 except 3SK1120, 3SK1211, 3SK2112) 	2	3ZY1450-1BB00	1
	<ul style="list-style-type: none"> - 45 mm wide (for 3SK2122) 	2	3ZY1450-1BC00	1
Blank labels				
 3RT2900-1SB20	Unit labeling plates For SIRIUS devices 20 mm x 7 mm, titanium gray ¹⁾			
	20	3RT2900-1SB20		100
Tools for opening spring-type terminals				
 3RA2908-1A	Screwdrivers For all SIRIUS devices with spring-type terminals; 3.0 mm x 0.5 mm; length approx. 200 mm, titanium gray/black, partially insulated			
	2	3RA2908-1A	Spring-type terminals (push-in) 	1

Overview



SIRIUS 3TK2810 safety relays

3TK2810-0 standstill monitors

The standstill monitor increases safety in hazardous areas. Without a sensor, it detects motor stoppage from the residual magnetization of the rotating motor. When an adjustable threshold value is undershot, it uses its outputs to allow access to hazardous areas, for example by unlocking a protective door.

3TK2810-1 speed monitors

The speed monitor combines two safety functions in one unit by continuously monitoring machines and plants for standstill and speed.

Through simple parameterization and permanent diagnosis on the display, faults can be quickly remedied at any time – often before they cause plant downtimes.

In addition to standstill and speed monitoring, the unit also features an integrated monitoring function of a protective door with spring-type interlocking. Therefore, an additional evaluation unit is not needed.

More information

Homepage, see www.usa.siemens.com/safety-relays
 Industry Mall, see <https://mall.industry.siemens.com/mall/en/us/Catalog/Products/8260001>

Article No. scheme

Product versions		Article number						
Safety relays with special functions		3TK2810	-	<input type="checkbox"/>	<input type="checkbox"/>	A	<input type="checkbox"/>	<input type="checkbox"/>
Device version	Standstill monitor	0						
	Speed monitor for NPN/PNP proximity switches and encoders	1						
Type of control supply voltage	24 V DC				B			
	230 V AC, 50/60 Hz				G			
	400 V AC, 50/60 Hz				J			
	120 ... 240 V AC/DC; 50/60 Hz				K			
Time delay	0.2 ... 6 s (standstill)						0	
	0 ... 999 s (release delay)						4	
Connection type	Screw terminals							1
	Spring-type terminals (push-in)							2
Version	Speed monitor for NAMUR proximity switches and encoders							- 0 A A 0
Example		3TK2810	-	0	B	A	0	1

Note:

The Article No. scheme shows an overview of product versions for better understanding of the logic behind the article numbers.

For your orders, please use the article numbers quoted in the selection and ordering data.

Benefits

3TK2810-0 standstill monitors

- No additional sensors required
- Signaling of faults with diagnostics display
- Standstill time can be set
- Unit can be used with frequency converters

3TK2810-1 speed monitors

- Menu-prompted, easy parameterization
- Direct diagnosis on the display means shorter downtimes thanks to early fault detection
- Integrated protective door monitoring means greater safety because access to the plant is allowed only in the safe state
- Suitable for all standard sensors, i.e. high flexibility

Technical specifications

More information

Operating instructions 3TK2810-0, see <https://support.industry.siemens.com/cs/ww/en/view/25437254>
 Manual 3TK2810-1, see <https://support.industry.siemens.com/cs/ww/en/view/43707376>

Technical specifications, see <https://support.industry.siemens.com/cs/ww/en/ps/16391/td>
 FAQs, see <https://support.industry.siemens.com/cs/ww/en/ps/16391/faq>

Type	3TK2810-0 standstill monitors	3TK2810-1 speed monitors
Sensors		
• Inputs	3	4
• Electronic	--	3
• With contacts	--	1
• Without sensors (measuring inputs)	3	--
• Magnetically operated switch (Reed contacts)	--	--
Safety mats		
	--	--
Start		
• Auto	✓	✓
• Monitored	--	✓
Cascading input 24 V DC		
	--	--
Key-operated switch		
	--	--
Enabling circuit, floating		
• Stop category 0	3 NO + 1 NC	2
• Stop category 1	--	--
Enabling circuit, electronic		
• Stop category 0	--	--
• Stop category 1	--	--

✓ Available
 -- Not available

Type	3TK2810-0 standstill monitors	3TK2810-1 speed monitors
Signaling outputs		
• Floating	1 CO	--
• Electronic	2	2
Standards		
	IEC 60204-1, EN ISO 12100, EN ISO 13849-1, IEC 61508	IEC 60947-5-1, EN ISO 13849-1, IEC 60204-1, IEC 61508
Test certificates		
	TÜV, UL, CSA	TÜV, UL, CSA
SIL level max. acc. to IEC 61508		
	3	3
Performance level PL acc. to EN ISO 13849-1		
	e	e
Probability of a dangerous failure per hour (PFH_d)		
	1.5 x 10 ⁻⁸ 1/h	3.38 x 10 ⁻⁹ 1/h
Rated control supply voltage		
• 24 V DC	✓	✓
• 230 V AC	✓	--
• 400 V AC	✓	--
• 120 ... 240 V AC/DC	--	✓

Selection and ordering data

PU (UNIT, SET, M) = 1
 PS* = 1 unit



3TK2810-0BA01



3TK2810-0GA02



3TK2810-1BA41





Rated control supply voltage U _s	Times	SD	Screw terminals	SD	Spring-type terminals	
V	s	d	Article No.	Price per PU	Article No.	Price per PU
Standstill monitors						
3TK2810-0						
• 24 DC	0.2 ... 6 (standstill)	5	3TK2810-0BA01	15	3TK2810-0BA02	
• 230 AC	0.2 ... 6 (standstill)	15	3TK2810-0GA01	15	3TK2810-0GA02	
• 400 AC	0.2 ... 6 (standstill)	15	3TK2810-0JA01	15	3TK2810-0JA02	
Speed monitors						
3TK2810-1 for NPN/PNP proximity switches and encoders						
• 24 DC	0 ... 999 (release delay)	2	3TK2810-1BA41	2	3TK2810-1BA42	
• 120 ... 240 AC/DC	0 ... 999 (release delay)	5	3TK2810-1KA41	5	3TK2810-1KA42	
3TK2810-1 for NAMUR proximity switches and encoders						
• 24 DC	0 ... 999 (release delay)	5	3TK2810-1BA41-0AA0	5	3TK2810-1BA42-0AA0	
• 120 ... 240 AC/DC	0 ... 999 (release delay)	5	3TK2810-1KA41-0AA0	5	3TK2810-1KA42-0AA0	

Safety Relays

SIRIUS 3TK28 Safety Relays

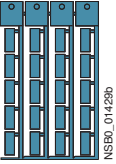
Accessories

Selection and ordering data

Use	Version	SD	Article No.	Price per PU	PU (UNIT, SET, M)	PS*
Blank labels						
 3RT1900-1SB20	For 3TK28	Unit labeling plates For SIRIUS devices 20 mm x 7 mm, pastel turquoise	20	3RT1900-1SB20	100	340 units
	For 3TK28	Adhesive labels For SIRIUS devices • 19 mm x 6 mm, pastel turquoise	15	3RT1900-1SB60	100	3 060 units
		• 19 mm x 6 mm, zinc yellow	15	3RT1900-1SD60	100	3 060 units
Push-in lugs and covers						
 3RP1903	For 3TK28	Push-in lugs For screw fixing, 2 units required per device	5	3RP1903	1	10 units
Adapters and connection cables for speed monitors						
 3TK2810-1A 3TK2810-1B	For 3TK2810-1	Adapters For connecting encoders of type Siemens/Heidenhain • 15-pole	2	3TK2810-1A	1	1 unit
		• 25-pole	2	3TK2810-1B	1	1 unit
 3TK2810-0A	For 3TK2810-1	Connection cables For connecting the speed monitor to the 3TK2810-1A or 3TK2810-1B adapter	15	3TK2810-0A	1	1 unit
Tools for opening spring-type terminals						
 3RA2908-1A	For auxiliary circuit connections	Screwdrivers For all SIRIUS devices with spring-type terminals; 3.0 mm x 0.5 mm; length approx. 200 mm, titanium gray/black, partially insulated	2	3RA2908-1A	1	1 unit

Overview

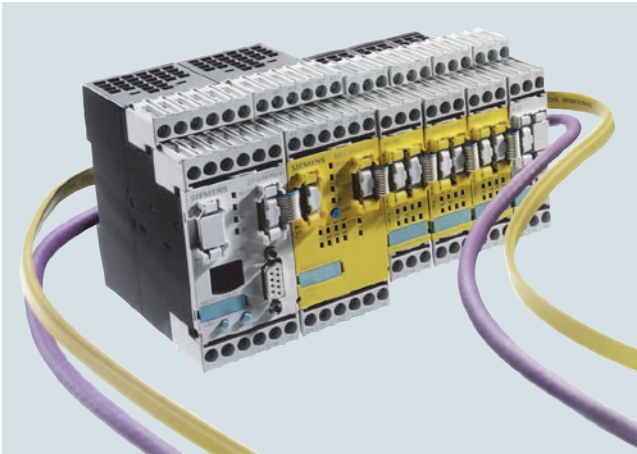

SIRIUS 3RK3 Modular Safety System

More information

Industry Mall, see <https://mall.industry.siemens.com/mall/en/us/Catalog/Products/10041776>

The 3RK3 Modular Safety System (MSS) is a freely configurable modular safety relay. Depending on the external circuit version, safety-related applications up to performance level e according to EN ISO 13849-1 or SIL 3 according to IEC 62061 can be realized.

The modular safety relay enables the interconnection of several safety applications.

The comprehensive error and status diagnostics provides the possibility of finding errors in the system and localizing signals from sensors. Plant downtimes can be reduced as the result.

The MSS comprises the following system components:

- Central units
- Expansion modules
- Interface modules
- Diagnostics modules
- Parameterization software
- Accessories

Central units

MSS Basic

The 3RK3 Basic central unit is used wherever several safety functions need to be evaluated and the wiring parameterization of safety relays would involve significant cost and effort. It reads in inputs, controls outputs and communicates through an interface module with higher-level control systems. An application's entire safety program is processed in the central unit. The 3RK3 Basic central unit is the lowest expansion level and fully functional on its own, without the optional expansion modules.

MSS Advanced

The 3RK3 Advanced central unit is the logical expansion of the Basic central unit with the functionality of an AS-i safety monitor. In addition to having a larger volume of project data and scope of functionality it can be integrated in AS-Interface and therefore make use of the many different possibilities offered by this bus system. The function can be optionally activated in the central unit.

The service-proven insulation piercing method of AS-Interface enables not only the distributed expansion of the project data volume using safe AS-i outputs, safe AS-i sensors and other MSS Advanced or safety monitors (F cross traffic) but also a highly flexible adaptation of the application, e.g. very fast connection of AS-i outputs, EMERGENCY STOP command devices, position switches with and without tumbler, or light curtains.

Safety-related disconnection using MSS or by distributed means using safe AS-i outputs and the formation of switch-off groups can be realized very easily. The same applies for any subsequent modifications. They are now possible by simply readdressing, meaning that rewiring is no longer necessary.

The AS-i bus is connected directly to the central unit.

MSS ASIsafe

The MSS ASIsafe basic and MSS ASIsafe extended central units are a logical development of the AS-i safety monitors based on the 3RK3 Modular Safety System.

Like MSS Advanced, MSS ASIsafe detects – in a comparable way to the safety monitors – safe sensor technology on the AS-i bus and switches actuators off in a safety-related manner via a configurable safety logic. It stands out by virtue of its greater project data volume, wider range of functions and the possibility of increasing the integrated I/O project data volume by means of expansion modules from the MSS system family. In this case the range of functions, such as the number and type of the logic elements that can be interconnected, is equivalent to that of MSS Advanced.

Expansion modules

With the optional expansion modules, both safety-related and standard, the system is flexibly adapted to the required safety applications.

Interface modules

The DP interface module is used for transferring diagnostics data and device status data to a higher-level PROFIBUS network, e.g. for purposes of visualization using HMI. When using the Basic central unit, 32-bit cyclic data can be exchanged with the control system. If an Advanced/ASIsafe central unit is used, the number is doubled to 64-bit cycle data. In acyclic mode, both central units can call up diagnostic data.

Diagnostics modules

Actuated sensors or faults, e.g. cross-circuit, are indicated directly on the diagnostics display. The fault is diagnosed directly in plain text by the detailed alarm message. The device is fully functional upon delivery. No programming is required.

Parameterization software

Using the SIRIUS Safety ES graphical parameterization tool, it is very easy to create the safety functions as well as their logical links on the PC. You can define disconnection ranges, ON-delays, OFF-delays and other dependencies for example.

SIRIUS Safety ES also offers comprehensive functions for diagnostics and commissioning. Documentation of the MSS hardware configuration and the parameterized logic is created automatically.

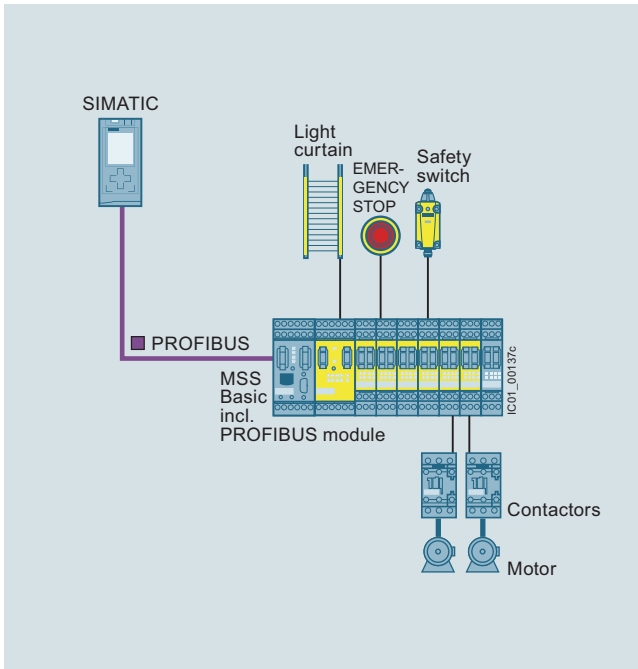

System design of MSS with Basic central unit

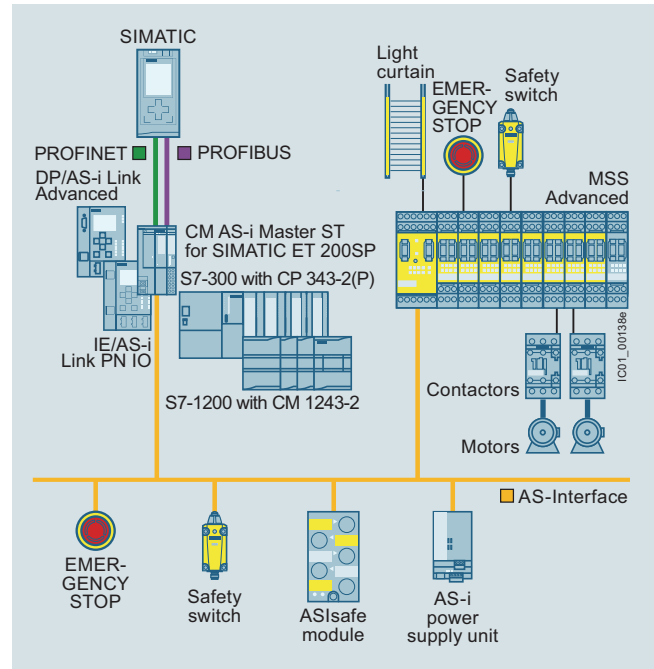

System design of MSS with Advanced central unit

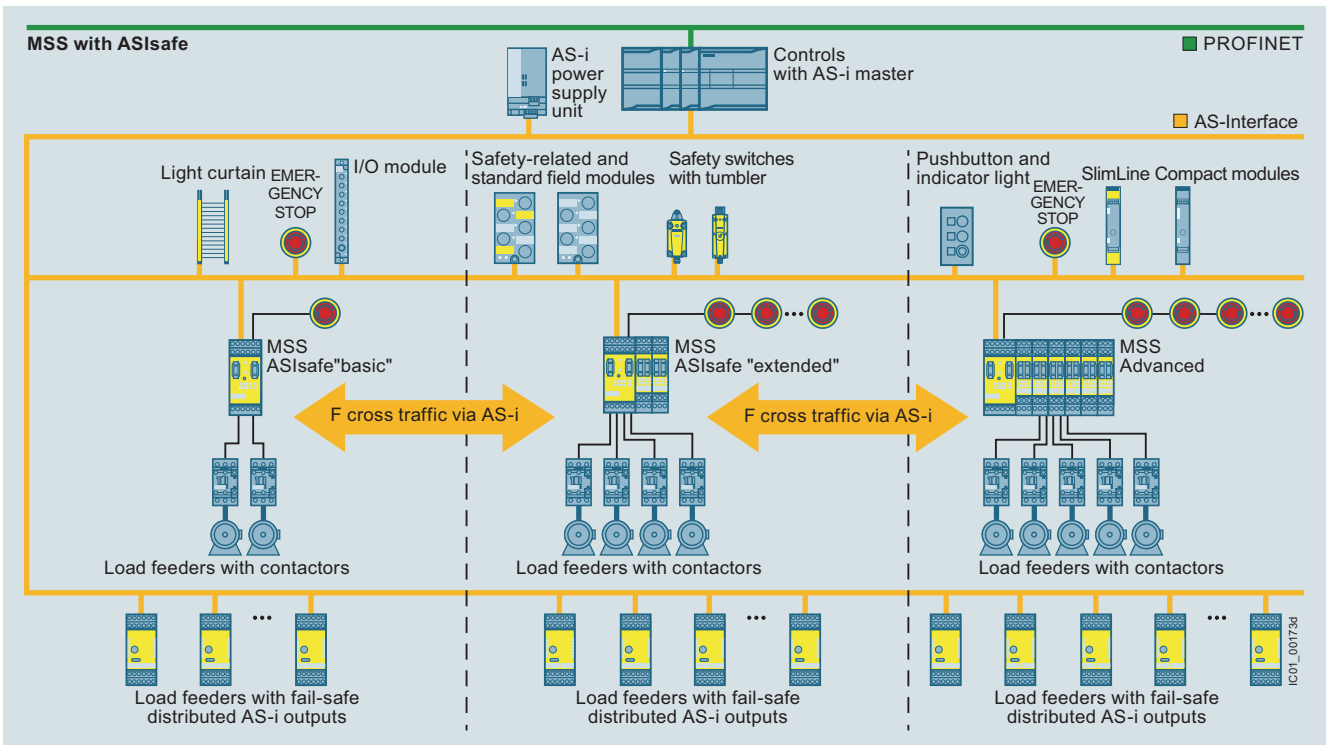

System design of MSS as a combination of various central units with AS-Interface

General data

Article No. scheme

Product versions		Article number						
Basic units		3RK3 1 <input type="checkbox"/> <input type="checkbox"/> - <input type="checkbox"/> A <input type="checkbox"/> <input type="checkbox"/> 0						
Device variants	3RK3 Basic	1	1					
	3RK3 ASIsafe "basic" variant	2	1					
	3RK3 ASIsafe "extended" variant	2	2					
	3RK3 Advanced	3	1					
Connection type	Screw terminals			1				
	Spring-type terminals			2				
Communication 1	None					A		
	AS-Interface without master					C		
Communication 2	3RK3122: max. 2 expansion modules can be connected						0	
	3RK3131: max. 9 expansion modules can be connected						1	
Example		3RK3 1 1 1 - 1 A A 1 0						

Product versions		Article number						
Expansion modules with safe inputs/outputs		3RK3 2 <input type="checkbox"/> <input type="checkbox"/> - <input type="checkbox"/> A A 1 0						
Device variants	4/8 F-DI	1	1					
	2/4 F-DI 1/2 F-RO	2	1					
	2/4 F-DI 2 F-DO	3	1					
	4 F-DO	4	2					
	4/8 F-RO	5	1					
Connection type	Screw terminals			1				
	Spring-type terminals			2				
Example		3RK3 2 1 1 - 1 A A 1 0						

Product versions		Article number						
Expansion modules with standard inputs/outputs		3RK3 3 <input type="checkbox"/> <input type="checkbox"/> - <input type="checkbox"/> A A 1 0						
Device variants	8 DO	1	1					
	8 DI	2	1					
Connection type	Screw terminals			1				
	Spring-type terminals			2				
Example		3RK3 3 1 1 - 1 A A 1 0						

Product versions		Article number						
DP interface modules		3RK3 5 1 1 - <input type="checkbox"/> B A 1 0						
Connection type	Screw terminals			1				
	Spring-type terminals			2				
Example		3RK3 5 1 1 - 1 B A 1 0						

Note:

The Article No. schemes show an overview of product versions for better understanding of the logic behind the article numbers.

For your orders, please use the article numbers quoted in the selection and ordering data.

Benefits

- More functionality and flexibility through freely configurable safety logic
- Suitable for all safety applications thanks to compliance with the highest safety standards in production automation
- For use all over the world through compliance with all product-relevant, globally established certifications
- Modular hardware configuration
- Parameterization by means of software instead of wiring
- Removable terminals for greater plant availability
- Distributed detection of sensors and disconnection of actuators through AS-Interface
- All logic functions can also be used for AS-Interface, e.g. muting, protective door with tumbler
- Up to 12 independent safe switch-off groups on the AS-i bus
- Volume of project data can be greatly increased by means of AS-Interface
- Up to 50 two-channel enabling circuits per system

Communication via PROFIBUS

The 3RK3 Modular Safety System can be connected to PROFIBUS through the DP interface and exchange data with higher-level control systems.

The MSS supports among other things:

- Baud rates up to 12 Mbps
- Automatic baud rate detection
- Cyclic services (DPV0) and acyclic services (DPV1)
- Exchange of 32-bit cyclic data with MSS Basic or 64-bit cyclic data with MSS Advanced/MSS ASIsafe
- Diagnostics using data record invocations

AS-Interface communication

Using the Advanced and ASIsafe "basic" and "extended" central units, the 3RK3 Modular Safety System can be integrated in AS-Interface.

- MSS can read and evaluate the I/O data of up to 31 AS-i modules
- Up to 12 safe output signals per MSS can be placed on the AS-i bus for switching safe AS-i output modules or for fail-safe cross traffic between multiple MSS stations
- Safe cross traffic between multiple MSS stations or between one MSS and AS-i safety monitors
- Standard signals, e.g. for acknowledgment, can also be output on the AS-i bus

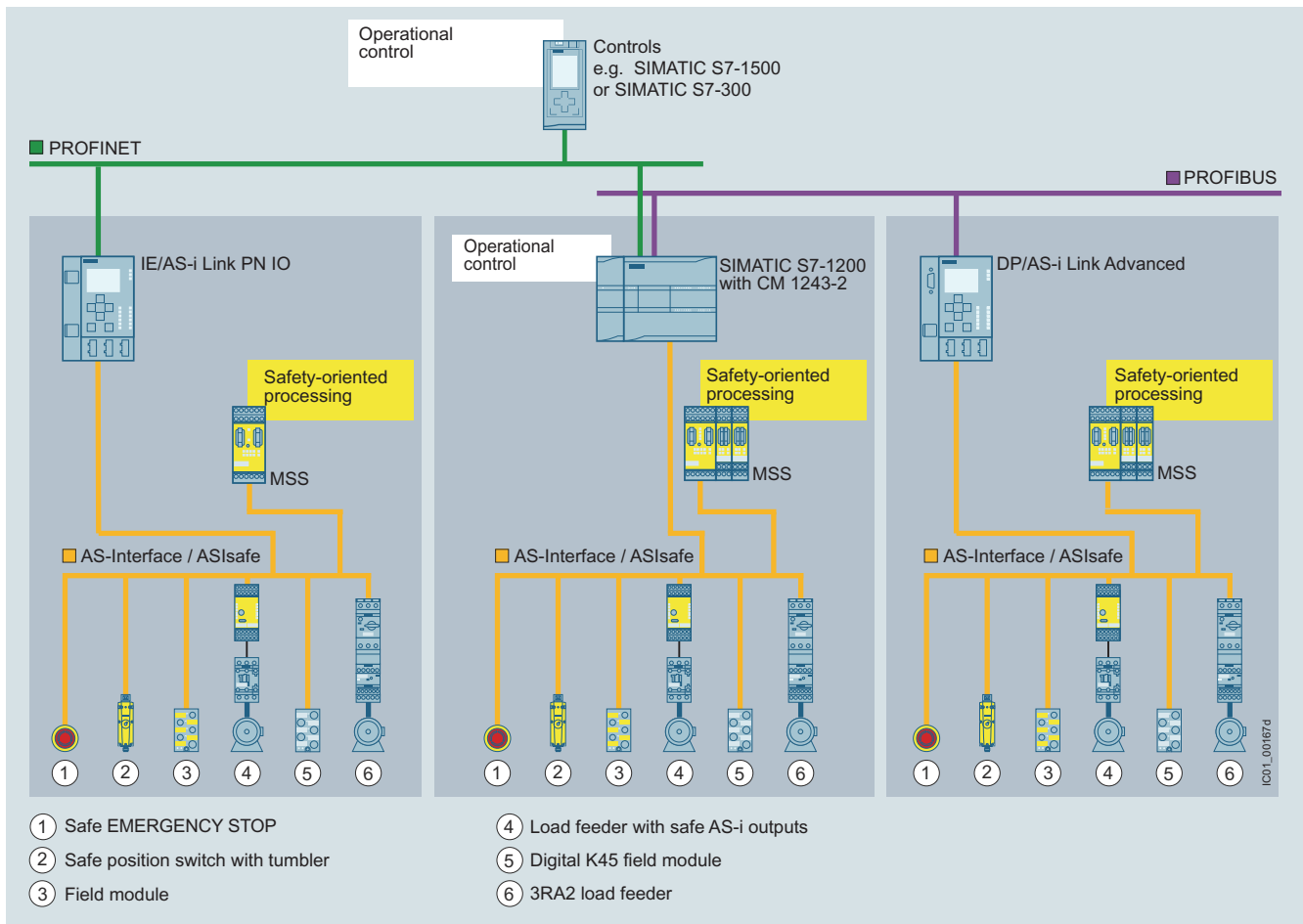











Integration of the MSS into AS-Interface

Notes:





















MSS with communication function, see page 13/159 onwards.
 Accessories, see page 13/161 onwards.
 SIRIUS Safety ES, see page 13/162.

Application

The 3RK3 Modular Safety System can be used for all safety-related requirements in the manufacturing industry and offers the following safety functions:

	Symbol	MSS Basic	MSS Advanced, MSS ASIsafe
Monitoring functions			
Universal monitoring Evaluation of any binary signals from single-channel and two-channel sensors		--	✓
EMERGENCY STOP Evaluation of EMERGENCY STOP devices with positive-opening contacts		✓	✓
Safety shutdown mat Evaluation of switching mats with NC contacts and/or crossover detection		✓	✓
Protective door monitoring Evaluation of protective door signals and/or protective flap signals		✓	✓
Protective door tumbler mechanism Evaluation of protective doors with tumbler and of the actuation/release of this tumbler		--	✓
Approval switches Evaluation of OK buttons with NO contact		✓	✓
Two-hand operator controls Evaluation of two-hand operator controls		✓	✓
ESPE monitoring Evaluation of non-contact protective devices, e.g. light curtains and laser scanners		✓	✓
Muting Temporary bridging of non-contact protective devices, 2/4 sensors in parallel, 4 sensors in sequence		--	✓
Mode selector switches Evaluation of operating mode selector switches with NO contacts		✓	✓
Monitoring AS-i (AS-i 2F-DI) Logic element for monitoring of AS-i input slaves		--	✓

✓ Available
-- Not available

	Symbol	MSS Basic	MSS Advanced, MSS ASIsafe
Logic operation functions			
AND		✓	✓
OR		✓	✓
XOR		✓	✓
NAND		✓	✓
NOR		✓	✓
Negation		✓	✓
Flip-flop		✓	✓
Counting functions			
Counter 0 -> 1		✓	✓
Counter 1 -> 0		✓	✓
Counter 0 -> 1/1-> 0		✓	✓
Timer functions			
With ON-delay		✓	✓
Passing make contact		✓	✓
With OFF-delay		✓	✓
Clock-pulsing		✓	✓
Start functions			
Monitored start		✓	✓
Manual start		✓	✓
Output functions			
Standard output		✓	✓
F output		✓	✓
AS-i output function		--	✓
Status functions			
Element status		--	✓

Technical specifications

More information

Manual, see <https://support.industry.siemens.com/cs/ww/en/view/26493228>

FAQs, see <https://support.industry.siemens.com/cs/ww/en/ps/16392/faq>

Technical specifications, see <https://support.industry.siemens.com/cs/ww/en/ps/16392/td>

Central units and expansion modules

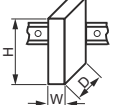
Type	Central units				Expansion modules							
	Basic	Advanced	ASIsafe basic	ASIsafe extended	4/8F-DI	2/4 F-DI 1/2 F-RO	2/4 F-DI 2F-DO	4/8 F-RO	4 F-DO	8 DI	8 DO	
Dimensions (W x H x D)												
												
• Screw terminals	mm	45 x 111 x 124			22.5 x 111 x 124			45 x 111 x 124	22.5 x 111 x 124			
• Spring-type terminals	mm	45 x 113 x 124			22.5 x 113 x 124			45 x 113 x 124	22.5 x 113 x 124			
Device data												
Shock resistance (sine pulse)	g/ms	15/11										
Touch protection acc. to IEC 60529		IP20										
Permissible mounting position		Vertical mounting surface (+10°/-10°), deviating mounting positions are permitted for reduced ambient temperature										
Minimum distances		For heat dissipation through convection from the devices 25 mm to the ventilation openings (top and bottom)										
Permissible ambient temperature												
• During operation	°C	-20 ... +60										
• During storage and transport	°C	-40 ... +85										
Number of sensor inputs (single-channel)												
• Fail-safe		8	8	2	4	8	4	4	--	--	--	
• Not fail-safe		--	--	6	4	--	--	--	--	8	--	
Number of test outputs		2							--			
Number of outputs												
• Relay outputs												
- Single-channel		--	--	--	--	--	2	--	8	--	--	
- Two-channel		1	1	1	1	--	--	--	--	--	--	
• Electronic outputs												
- Single-channel		--	--	--	--	--	--	--	--	--	8	
- Two-channel		1	1	1	1	--	--	2	--	4	--	
Weight	g	300			160			400		135	125	160
Installation altitude above sea level	m	2 000										
Environmental data												
EMC interference immunity		IEC 60947-5-1										
Vibrations												
• Frequency	Hz	5 ... 500										
• Amplitude	mm	0.75										
Climatic withstand capability		IEC 60068-2-78										

Type	Central units				Expansion modules						
	Basic	Advanced	ASIsafe basic	ASIsafe extended	4/8 F-DI	2/4 F-DI 1/2 F-RO	2/4 F-DI 2 F-DO	4/8 F-RO	4 F-DO	8 DI	8 DO
Electrical specifications											
Rated control supply voltage U_s acc. to IEC 61131-2	V	24 DC \pm 15% ¹⁾									
Operating range		0.85 ... 1.15 x U_s									
Rated insulation voltage U_i	V	300			50	300	50	300	50		
Rated impulse voltage U_{imp}	kV	4			0.5	4	0.5	4	0.5		
Total current input	mA	185			60	85		140	8	78	60
Rated power at U_s	W	4.5			1.5	2		3	4.8	1.9	1.5
Utilization category acc. to IEC 60947-5-1											
Relay outputs											
• AC-15 at 230 V	A	2			--	2	--	2	--	--	--
• DC-13 at 24 V	A	1			--	1	--	1	--	--	--
Semiconductor outputs											
• DC-13 at 24 V	A	1.5			--	--	1.2	--	2	--	0.5
Mechanical endurance During rated operation	Operating cycles (relay)	10 x 10 ⁶			--	10 x 10 ⁶	--	10 x 10 ⁶	--		
Switching frequency z At rated operational current	1/h	1 000			--	1 000		360	1 000	--	1 000
Conventional thermal current I_{th}	A	2/1.5			--	1	1.2	3	2	--	0.5
Protection for output contacts											
Fuse links											
LV HRC type 3NA, DIAZED type 5SB, NEOZED type 5SE											
• Operational class gG	A	4			--	4	--	4	--		
• Operational class quick	A	6			--	6	--	6	--		
Safety specifications											
Probability of a dangerous failure											
• per hour (PFH _d)	1/h	5.14 x 10 ⁻⁹	3.8 x 10 ⁻⁹ with AS-i, 2.8 x 10 ⁻⁹ without AS-i		1.89 x 10 ⁻⁹	3.79 x 10 ⁻⁹	2.7 x 10 ⁻⁹	7.15 x 10 ⁻⁹	3.18 x 10 ⁻⁹	--	
• On demand (PFD)		1.28 x 10 ⁻⁵	1.7 x 10 ⁻⁴		4.29 x 10 ⁻⁶	5.85 x 10 ⁻⁶	8.34 x 10 ⁻⁶	4.36 x 10 ⁻⁵	2.2 x 10 ⁻⁵	--	
Parameters for cables											
Line resistance	Ω	100						--		100	--
Cable length from terminal to terminal With Cu 1.5 mm ² and 150 nF/km	m	1 000						--		1 000	--
Conductor capacity	nF	330						--		330	--

¹⁾ Device current supply through a power supply unit according to IEC 60536 protection class III (SELV or PELV).

Interface and diagnostics modules

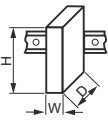
Type	Interface modules		Diagnostics modules
Dimensions (W x H x D)			
 <ul style="list-style-type: none"> • Screw terminals • Spring-type terminals 	mm	45 x 111 x 124	96 x 60 x 44
	mm	45 x 113 x 124	--
Device data			
Shock resistance (sine pulse)	g/ms	15/11	
Touch protection acc. to IEC 60529		IP20	
Permissible mounting position		Vertical mounting surface (+10°/-10°), deviating mounting positions are permitted for reduced ambient temperature	
Minimum distances		For heat dissipation through convection from the devices 25 mm to the ventilation openings (top and bottom)	
Permissible ambient temperature			
• During operation	°C	-20 ... +60	
• During storage and transport	°C	-40 ... +85	
Weight	g	270	90
Installation altitude above sea level	m	2 000	
Environmental data			
EMC interference immunity		IEC 60947-5-1	
Vibrations			
• Frequency	Hz	5 ... 500	
• Amplitude	mm	0.75	
Climatic withstand capability		IEC 60068-2-78	
Electrical specifications			
Rated control supply voltage U_s acc. to IEC 61131-2	V	24 DC ± 15%	24 DC ± 15% via connecting cable to the central unit
Operating range		0.85 ... 1.15 x U_s	
Rated insulation voltage U_i	V	50	
Rated impulse voltage U_{imp}	kV	0.5	
Total current input	mA	--	24
Rated power at U_s	W	--	0.6

Selection and ordering data



3RK3111-1AA10



3RK3121-1AC00
3RK3122-1AC00
3RK3131-1AC10

Version	SD	Article No.	Price per PU	PU (UNIT, SET, M)	PS*
3RK31 central units					
<p>3RK3 Basic</p> <p>Central units with safety-related inputs and outputs</p> <ul style="list-style-type: none"> • 8 fail-safe inputs • 1 two-channel relay output • 1 two-channel electronic output <p>Max. 7 expansion modules can be connected</p> <p><u>Note:</u> Memory module 3RK3931-0AA00 is included in the scope of supply.</p>	2	3RK3111-□AA10		1	1 unit
<p>3RK3 Advanced</p> <p>Central units for connecting to AS-Interface with safety-related inputs and outputs and extended functional scope</p> <ul style="list-style-type: none"> • 8 fail-safe inputs • 1 two-channel relay output • 1 two-channel electronic output <p>Max. 9 expansion modules can be connected</p> <p><u>Note:</u> Memory module 3RK3931-0AA00 is included in the scope of supply.</p>	2	3RK3131-□AC10		1	1 unit
<p>3RK3 ASIsafe</p> <p>Central units for connecting to AS-Interface with safety-related inputs and outputs and extended functional scope</p> <ul style="list-style-type: none"> • 1 two-channel relay output • 1 two-channel electronic output <p>"Basic" version</p> <ul style="list-style-type: none"> • 2 fail-safe inputs • 6 non-fail-safe inputs <p>No expansion modules can be connected</p> <p>"Extended" version</p> <ul style="list-style-type: none"> • 4 fail-safe inputs • 4 non-fail-safe inputs <p>Max. 2 expansion modules can be connected</p> <p><u>Note:</u> Memory module 3RK3931-0AA00 is included in the scope of supply.</p>	2	3RK3121-□AC00		1	1 unit
	2	3RK3122-□AC00		1	1 unit
<p>Type of electrical connection</p> <ul style="list-style-type: none"> • Screw terminals • Spring-type terminals (push-in) 					

1
2

Safety Relays

SIRIUS 3RK3 Modular Safety System

3RK32, 3RK33 expansion modules, 3RK35 interface modules

Selection and ordering data



3RK3211-1AA10
3RK3221-1AA10
3RK3231-1AA10
3RK3242-1AA10



3RK3251-1AA10



3RK3311-1AA10
3RK3321-1AA10



3RK3511-1BA10

Version	SD	Article No.	Price per PU	PU (UNIT, SET, M)	PS*
3RK32, 3RK33 expansion modules					
4/8 F-DI Safety-related input module • 8 inputs	2	3RK3211-□AA10		1	1 unit
2/4 F-DI 1/2 F-RO Safety-related input/output module • 4 inputs • 2 single-channel relay outputs	2	3RK3221-□AA10		1	1 unit
2/4 F-DI 2F-DO Safety-related input/output module • 4 inputs • 2 two-channel electronic outputs	2	3RK3231-□AA10		1	1 unit
4/8 F-RO Safety-related output module • 8 single-channel relay outputs	2	3RK3251-□AA10		1	1 unit
4 F-DO Safety-related output module • 4 two-channel electronic outputs	2	3RK3242-□AA10		1	1 unit
8 DI Standard input module • 8 inputs	2	3RK3321-□AA10		1	1 unit
8 DO Standard output module • 8 electronic outputs	2	3RK3311-□AA10		1	1 unit
3RK35 interface modules					
DP interface PROFIBUS DP interface, 12 Mbps, RS 485, 32-bit cyclic data exchange with Basic central unit or 64-bit with Advanced and ASIsafe central unit, acyclic exchange of diagnostics data	2	3RK3511-□BA10		1	1 unit

Type of electrical connection









- Screw terminals
- Spring-type terminals (push-in)

Notes:

For the required connection cable, [see page 13/161](#).

1
2

Selection and ordering data

Version	SD	Article No.	Price per PU	PU (UNIT, SET, M)	PS*	
Connection cables (essential accessory)						
 3UF7932-0AA00-0	For connection of					
	Central units with expansion modules or interface module	Diagnostics modules with central unit or interface module	Length			
	✓	✓	• 0.025 m (flat)	▶ 3UF7930-0AA00-0	1	1 unit
	--	✓	• 0.1 m (flat)	▶ 3UF7931-0AA00-0	1	1 unit
	--	✓	• 0.15 m (flat) NEW	▶ 3UF7934-0AA00-0	1	1 unit
	--	✓	• 0.3 m (flat)	▶ 3UF7935-0AA00-0	1	1 unit
	--	✓	• 0.5 m (flat)	▶ 3UF7932-0AA00-0	1	1 unit
	--	✓	• 0.5 m (round)	▶ 3UF7932-0BA00-0	1	1 unit
	--	✓	• 1.0 m (round)	▶ 3UF7937-0BA00-0	1	1 unit
--	✓	• 2.5 m (round)	▶ 3UF7933-0BA00-0	1	1 unit	
Operating and monitoring modules for 3RK3						
 3SK2611-3AA00	Diagnostics modules	2	3SK2611-3AA00	1	1 unit	
	For direct display of errors, e.g. of cross-circuits					
PC cables and adapters						
 3UF7941-0AA00-0	USB PC cables	▶	3UF7941-0AA00-0	1	1 unit	
	For connecting to the USB interface of a PC/PG, for communication with 3RK3 through the system interface, recommended for use in connection with 3RK3					
Door adapter						
 3UF7920-0AA00-0		▶	3UF7920-0AA00-0	1	1 unit	
	For external connection of the system interface, e.g. outside a control cabinet					
Interface covers						
 3UF7950-0AA00-0		▶	3UF7950-0AA00-0	1	5 units	
	For system interface					
Memory modules						
 3RK3931-0AA00		2	3RK3931-0AA00	1	1 unit	
	For backing up the complete parameterization of the 3RK3 Modular Safety System without a PC/PG through the system interface					
Push-in lugs						
 3RP1903		5	3RP1903	1	10 units	
	For screw fixing, e.g. on mounting plate, 2 units required per device Can be used for 3RK3					
Software for 3RK3						
 3ZS1316-C.10-0Y.5	SIRIUS Safety ES					
	Software for configuring, commissioning, operating and diagnosing of 3SK2 and 3RK3, see page 13/162 .					

✓ Available
-- Not available

Overview

More information

Technical specifications, see <https://support.industry.siemens.com/cs/ww/en/ps/21192/td>
 Programming and Operating Manual, see <https://support.industry.siemens.com/cs/ww/en/view/109444445>.

SIRIUS Safety ES is the engineering software for the configuration, startup and diagnostics of the 3RK3 Modular Safety System and 3SK2 safety relays. The software combines the configuring of the hardware, the parameterization of the safety functions, and the testing and diagnostics of the safety system.

Efficient engineering with three program versions

The SIRIUS Safety ES software program is available in three versions which differ in their user-friendliness, scope of functions and price.

SIRIUS Safety ES	Basic	Standard	Premium
Access via the local interface on the device	✓	✓	✓
Parameter assignment	✓	✓	✓
Operating	✓	✓	✓
Diagnostics	✓	✓	✓
Test	--	✓	✓
Integrated graphics editor	✓	✓	✓
Importing/exporting parameters	--	✓	✓
Comparison functions	--	✓	✓
Comfort functions	--	✓	✓
Terminal designator	--	✓	✓
Work on sub-diagrams	--	✓	✓
Standard-compliant printout according to EN ISO 7200	✓	✓	✓
Downloading parameterization via PROFIBUS	--	--	✓
Online diagnostics using PROFIBUS	--	--	✓
Creating, importing and exporting macros	--	--	✓

✓ Function available
 -- Function not available

Additional functions

Language selection

The program interface language can be switched during use between German, English and French

Help function

A context-sensitive help function provides useful assistance with questions concerning the use of the program

Consistency check

A consistency check provides clear information about function assignment errors and users are taken directly to errors when the corresponding message is clicked on. Checks are carried out automatically when a project is saved and during the configuration test, but they can also be initiated manually.

Lists

Lists of symbols and cross-references can be issued for effective processing of the project file

Standard-compliant printouts

The programs of the SIRIUS ES software family make machine documentation far easier. They enable parameterization printouts according to EN ISO 7200. The elements to be printed are easy to select and group as required.

Hardware configuration

The device configuration of the 3RK3 or 3SK2 systems is defined in the configuration dialog. The available modules are simply selected from the clearly laid out hardware catalog and positioned in the workspace. Depending on the device system used (3RK3 or 3SK2), only the permitted devices are shown in the hardware catalog in each case. In addition, in the case of the 3RK3, the quantity framework on the AS-i bus can be determined online or configured manually from the AS-i library. For each module, it is optionally possible to issue an equipment ID which is shown in the logic diagram for identification of the inputs and outputs.

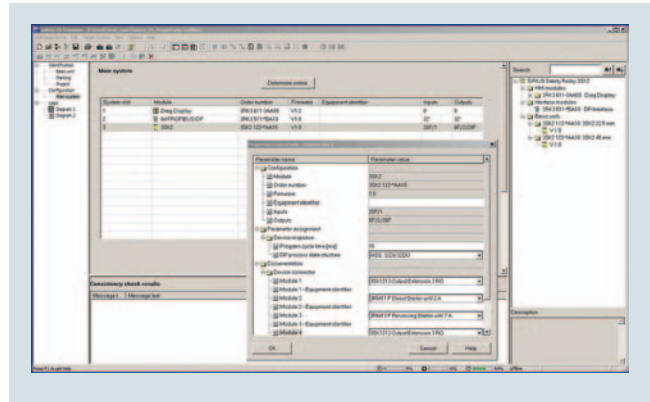

Definition of the hardware layout

Graphic parameterizing of the safety logic via drag & drop

The functionality of the safety logic is laid down with a graphics editor designed for intuitive operation. Safe monitoring functions (EMERGENCY STOP, non-contact protective devices/light arrays, protective doors, etc.), output functions and logic functions (AND/OR operations, counting function, time functions, etc.), non-safety-related input/output functions, device status functions and control functions can be dragged from the extensive functions catalog onto the work interface by drag & drop. Depending on the version, each function has several input and output connecting points through which the functions can be interconnected by simple mouse clicks. Double-clicking on a function symbol opens the related features dialog window in which all the parameters can be displayed and configured: Scope of the function's inputs and outputs, configuring the channel type (single-/two-channel, NC contact/NO contact), activating crossover detection, defining start options, assigning the hardware inputs and outputs, etc. Of course each function can be issued with an individual name so that e.g. the position of a safety switch in the plant can be documented.

Parameterization, Configuration and Visualization

SIRIUS 3RK and 3SK Safety Software

SIRIUS Safety ES

The safety logic can be divided into several diagrams in order to enable structured processing of the entire plant. The user can freely position the functions on a quasi infinitely large drawing board, whereby the connecting lines are drawn automatically. If there is not enough space, more pages are automatically added to the diagram in horizontal or vertical direction. Connecting lines extending over several pages are automatically issued with cross-references during print-out. If required in the interest of clarity, the user can divide a connecting line manually into two segments, whereby the mutual reference is marked by reference arrows. For further documentation, freely compilable comment texts can be placed at any point in the diagram. Every point in the logic diagram can be processed with ease by dragging and zooming.

Every project can be saved as a file and be password-protected from unauthorized access.

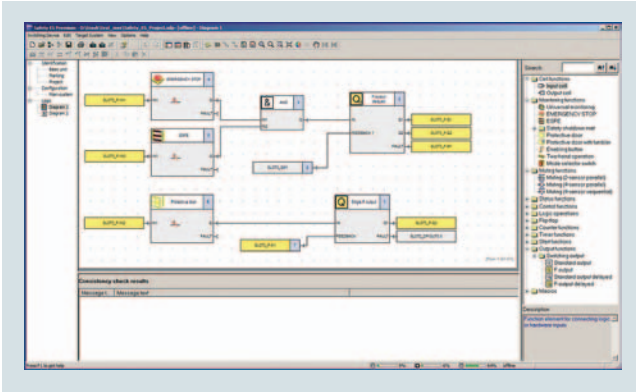

Processing the safety functions in the graphics editor

AS-Interface

Evaluation of the AS-i slaves connected to the AS-i bus is also parameterized using the tried and tested method described above.

In order to be able to use the AS-i functionalities, a 3RK3 Advanced central unit or 3RK3 ASI-safe central unit (basic/extended) must be used.

User prompting during startup and maintenance

To start up the relevant safety system, the created project file is uploaded to the device. There are two ways of doing this:

- Connect the USB interface of the PC to the device using an appropriate connection cable.
- Use the DP interface to download the parameterization via any PROFIBUS node.

Access to the device can be restricted using a password concept that includes different protection levels.

After the project is loaded, the user switches the device by means of the software from configuring mode to test mode in which the safety functions can be tested.

Activating the diagnostics shows the status of the individual functions in the graphic logic diagram by means of different colors and symbols. In addition, more detailed information about each function element can be displayed in the logic diagram. For the purpose of testing the logic diagram, it is also possible to manually overwrite the signal state of each function element ("forcing").

If the test is completed successfully, the user releases the configuration and switches the device to protection mode, in which case "forcing" is automatically deactivated.

Service personnel can activate the graphic diagnostics in protection mode as well. The I&M (Identification & Maintenance) data saved in the device facilitate maintenance.

Benefits

- Convenient parameterization, operation, monitoring and testing by means of a user-friendly and clear-cut user interface
- Reliable diagnostic tool
- All functions, such as safety and logic functions, are available as modules, and are easy to link to one another
- Automatic creation of comprehensive documentation of safety functions

Parameterization, Configuration and Visualization

SIRIUS 3RK and 3SK Safety Software

SIRIUS Safety ES

Selection and ordering data

SIRIUS Safety ES parameterization, start-up and diagnostics software

- Delivered without PC cable

Version	SD	Article No.	Price per PU	PU (UNIT, SET, M)	PS*
---------	----	-------------	--------------	-------------------	-----

SIRIUS Safety ES Basic



Floating license for one user

Engineering software in limited-function version for diagnostics purposes, software and documentation on CD, 3 languages (German/English/French), communication via system interface

- License key on USB flash drive, Class A
- License key download, Class A

2

3ZS1316-4CC10-0YA5
3ZS1316-4CE10-0YB5

1

1 unit

3ZS1316-4CC10-0YA5

SIRIUS Safety ES Standard



Floating license for one user

Engineering software, software and documentation on CD, 3 languages (German/English/French), communication via system interface

- License key on USB flash drive, Class A
- License key download, Class A

5

3ZS1316-5CC10-0YA5
3ZS1316-5CE10-0YB5

1

1 unit

3ZS1316-5CC10-0YA5

SIRIUS Safety ES Premium



Floating license for one user

Engineering software, software and documentation on CD, 3 languages (German/English/French), communication via PROFIBUS or system interface, online diagnostics via PROFIBUS, creating, importing and exporting macros

- License key on USB flash drive, Class A
- License key download, Class A

5

3ZS1316-6CC10-0YA5
3ZS1316-6CE10-0YB5

1

1 unit

3ZS1316-6CC10-0YA5

Notes:

Please order PC cable separately, see [Accessories](#).

For a description of the software versions, see [page 14/22](#).

Accessories

Version	SD	Article No.	Price per PU	PU (UNIT, SET, M)	PS*
---------	----	-------------	--------------	-------------------	-----

Optional accessories



USB PC cables

For connecting to the USB interface of a PC/PG, for communication with 3RK3 and 3SK2 via the system interface, recommended for use in connection with 3RK3 and 3SK2

▶

3UF7941-0AA00-0

1

1 unit

3UF7941-0AA00-0