

contents

5SJ4 Branch Circuit Protectors



5SJ4	Page
Selection and ordering data	
• 1-pole up to 63A	16/4
• 1-pole, 2-pole, 3-pole, 240VAC	16/5
• 1-pole, 2-pole, 3-pole, 480Y/277VAC	16/6
• Additional components	16/7

General data	16/3
Tripping characteristics	16/2
Dimension drawings	16/10
Technical data	16/8

5SY4 Supplementary Protectors

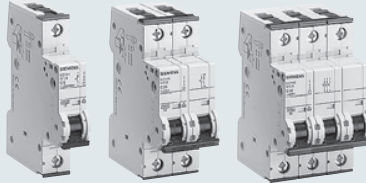

5SY4	Page
Selection and ordering data	
• 1-pole, 1-pole+ N, and 2-pole up to 63A	16/13
• 3-pole, 3-pole + N, and 4-pole up to 63A	16/14
• Additional components	16/19
• Accessories	16/21

General data	16/11, 16/22
Tripping characteristics	16/2
Dimension drawings	16/25
Technical data	16/23

5SY6 Supplementary Protectors

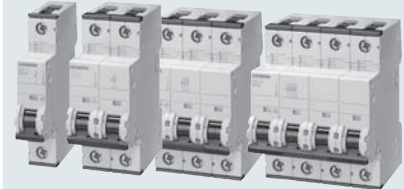

5SY6	Page
Selection and ordering data	
• 1-pole, 1-pole+ N, and 2-pole up to 63A	16/15
• 3-pole, 3-pole + N, and 4-pole up to 63A	16/16
• Additional components	16/19
• Accessories	16/21

General data	16/11, 16/22
Tripping characteristics	16/2
Dimension drawings	16/25
Technical data	16/23

5SP Supplementary Protectors

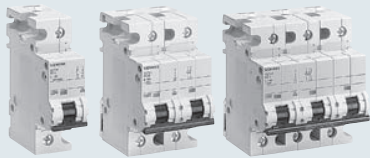

5SP4	Page
Selection and ordering data	
• 1-pole, 2-pole, 3-pole and 4-pole up to 125A	16/17
• Additional components	16/19
• Accessories	16/21

General data	16/11, 16/22
Tripping characteristics	16/2
Dimension drawings	16/25
Technical data	16/23

AC/DC Product Range 5SY5 Supplementary Protectors

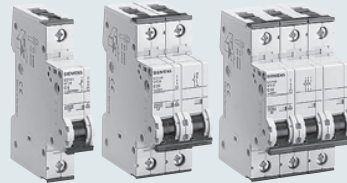

5SY5	Page
Selection and ordering data	
• 1-pole, 2-pole up to 63A	16/18
• Additional components	16/17
• Accessories	16/21

General data	16/11
Tripping characteristics	16/2
Dimension drawings	16/25
Technical data	16/23

3NW7 Cylindrical Fuse Holders



3NW7 and 3NC10	Page
Selection and ordering data	
3NW7	
• 1-, 1+N, 2- and 3-, 3+N and 4-poles up to 100 A	16/27

General data	16/26
Dimension drawings	16/29
Technical data	16/28

Tripping characteristics acc. to EN 60 898

Tripping characteristic A, -5

Type A characteristic is designed to protect very sensitive circuits such as semiconductors. Magnetic trip point - 2 to 3 times I_n rating. Thermal trip point - 1.13 to 1.45 protector rating.

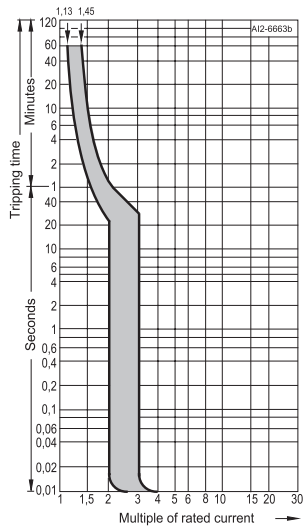

Tripping characteristic B, -6

Type B characteristic designed for European residential circuit protection. This characteristic can also be used for protection of computers and electronic equipment. Magnetic trip point - 3 to 5 times I_n rating. Thermal trip point - 1.13 to 1.45 protector rating.

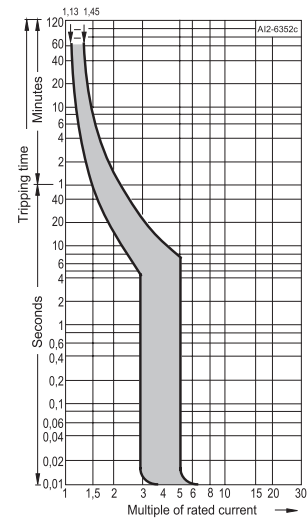

Tripping characteristic C, -7

Type C characteristic is for general device protection in control circuits. Magnetic trip point - 5 to 10 times I_n rating. Thermal trip point - 1.13 to 1.45 protector rating.

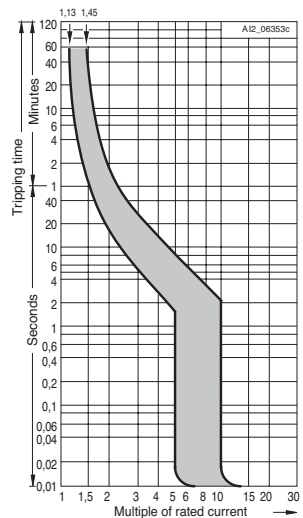

Tripping characteristic D, -8

Type D characteristic is designed for high inrush loads. Magnetic trip point - 10 to 20 times I_n rating. Thermal trip point - 1.13 to 1.45 protector rating.

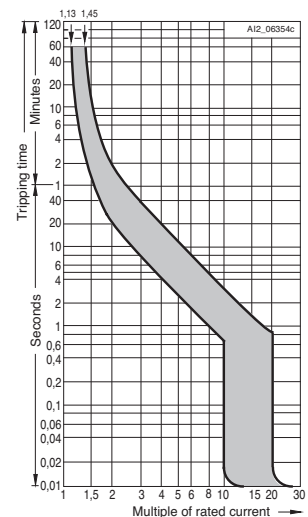



For different ambient temperatures, the current values of the delayed tripping operation change by approximately 5% per 10°K temperature difference. Specifically they increase for temperatures below 25°C (5SJ41), 30°C (5SP, 5SY) and decrease for temperatures above 25°C (5SJ41), 30°C (5SP, 5SY).

For DC voltages the maximum current values of the instantaneous tripping operation increase by a factor of 1.2.

If more than one electrical circuit is loaded in a series of miniature circuit breakers or supplementary protectors, the resulting increase in ambient temperature affects the characteristic curve. In this case an additional correction factor found in the following table must be used.

Number	1	2 - 3	4 - 6	> 7
Correction factor K	1.00	0.90	0.88	0.85

Selection and ordering data

5SJ4 Miniature Circuit Breaker Guide			
Catalog Series	5SJ41...-.HG40	5SJ4...-.HG41	5SJ4...-.HG42
Rated Voltage	240, 120 VAC 60 VDC Same Polarity	240 VAC 60/125 VDC	480Y/277 VAC 60/125 VDC
Number of Poles	1-Pole	1-, 2- and 3-Poles	
Trip Characteristics	B, C, D	C, D	
Rated Current	B Characteristic: 6 to 63 A C and D Characteristic: 0.3 to 63 A		C Characteristic: 0.3 to 40 A D Characteristic: 0.3 to 32 A
Interrupting Ratings ¹⁾	B Characteristic: 14 kA (6 to 63 A)	—	—
	C Characteristic: 14 kA (0.3 to 40 A) 10 kA (45 to 63 A)		C Characteristic: 10 kA (0.3 to 40 A) ²⁾
	D Characteristic: 14 kA (0.3 to 20 A) 10 kA (25 to 63 A)		D Characteristic: 10 kA (0.3 to 32 A) ²⁾

1) 14 kA = Type HSJ; 10 kA = Type NSJ.

2) At 240 VAC the Interrupting Rating is the same as the 5SJ4...-.HG40 and .HG41.

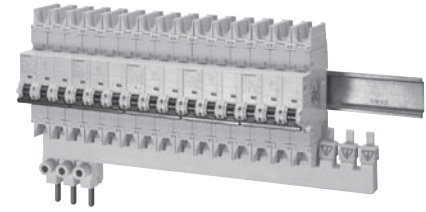

5SJ4...-.HG41 Miniature Circuit Breakers

Certifications:

CE

UL Listed and Certified to Canadian
Standards
HACR Rated

Features

Features – UL 489

- Suitable for Branch Circuit Protection Applications up to 277 VAC and 60 VDC (1-pole); and, up to 480Y VAC and 125 VDC (2- and 3-pole)
- UL Listed and Certified to Canadian Standards, File E243414
- HACR Rated
- High AC Interrupting Ratings of up to 14,000 (Type HSJ) or 10,000 (Type NSJ) Maximum RMS Symmetrical Amps and, DC interrupting ratings of 10,000 Amps
- 40°C Calibration Base (Industrial Applications)
- Can be used for "field wiring" applications; AWG 14 to AWG 4, Copper (Cu) Only
- Suitable for "reverse feed" applications

Features – EN/IEC 60 898

- 30°C Calibration Base
- Trip Characteristic B, C and D
B: Designed for the protection of computers and electronic equipment. Magnetic trip point is 3 to 5 times the MCB rating.
C: Designed for general device protection in control circuits and all other miniature circuit breaker systems. Magnetic trip point is 5 to 10 times the MCB rating.
D: Designed for high inrush loads. Magnetic trip point is 10 to 20 times the MCB rating.
- Rated voltage of 24 VAC minimum, 440 VAC Maximum and 60 VDC per pole
- High Interrupting Rating (I_{cn}) of up to 10,000 Amps
- 0.75 to 35 mm² solid and stranded conductors

Features – Common

- Depending on the device selected
 - Available with 1-, 2- or 3-poles
 - Available from 0.3 to 63 amps
- Visible Indicator for ON and OFF/Trip
- Touch Protection to EN50274
- DIN Rail Mounting (Standard 35 mm)
- Identical Wire Screw Connections on Line and Load Sides
- Smaller Size than traditional MCCB's

Auxiliary Circuit Switches (AS) are available with One Normally Open + One Normally Closed, Two Normally Open or Two Normally Closed contacts. They are primarily used to signal the miniature circuit breaker's trip mechanism position.

Fault Signal Contacts (FC) are available with One Normally Open + One Normally Closed, Two Normally Open or Two Normally Closed contacts. They are primarily used to signal the automatic tripping of the miniature circuit breaker's trip mechanism; and, trip position.

Shunt Trip Switches (ST) are available in voltages of 110 to 480 VAC and 24 to 60 V AC/DC. They are used for remote tripping of a miniature circuit breaker.

5ST366-.HG busbars, touch protection covers and terminal connectors are intended for use with Siemens lines of 5SJ4...-.HG4. UL 489 Miniature Circuit Breakers. They are UL Recognized (File E32159) with a rating of 115 Amps maximum at 480Y/277 VAC. Busbars are available in 1-, 2- or 3-pole versions.

Touch Protection Covers are used to cover any unused busbar terminals. They are intended to protect a user from live electrical parts.

Terminal Connectors are used to connect electrical conductors up to 1 AWG (50mm²) to the busbar terminals. Two versions are available; connect directly to the miniature circuit breaker or direct connection to the busbar.

5SJ Branch Circuit Protection

5SJ4 70 mm mounting depth

Features

5SJ41...HG40 miniature circuit breakers are designed to comply with UL 489 and CSA 22.2 No. 5-02 standards. They are used in single pole, branch circuit protection applications up to 240 VAC maximum and 60 VDC maximum, same polarity. Refer to Technical Data (page 16/8) for additional information.

Selection and ordering data

	I_n	Characteristic B			Characteristic C			Characteristic D			Weight 1 Item kg
		Order No.	Inter- ruption Type ¹⁾	List Price \$ 1 item	Order No.	Inter- ruption Type ¹⁾	List Price \$ 1 item	Order No.	Inter- ruption Type ¹⁾	List Price \$ 1 item	
	A										
	1-pole	0.3	—	—	5SJ4114-7HG40	HSJ		5SJ4114-8HG40	HSJ		0.155
		0.5	—	—	5SJ4105-7HG40	HSJ		5SJ4105-8HG40	HSJ		
		1	—	—	5SJ4101-7HG40	HSJ		5SJ4101-8HG40	HSJ		
		1.6	—	—	5SJ4115-7HG40	HSJ		5SJ4115-8HG40	HSJ		
		2	—	—	5SJ4102-7HG40	HSJ		5SJ4102-8HG40	HSJ		
		3	—	—	5SJ4103-7HG40	HSJ		5SJ4103-8HG40	HSJ		
		4	—	—	5SJ4104-7HG40	HSJ		5SJ4104-8HG40	HSJ		
		5	—	—	5SJ4111-7HG40	HSJ		5SJ4111-8HG40	HSJ		
		6	5SJ4106-6HG40	HSJ	5SJ4106-7HG40	HSJ		5SJ4106-8HG40	HSJ		
		8	—	—	5SJ4108-7HG40	HSJ		5SJ4108-8HG40	HSJ		
		10	5SJ4110-6HG40	HSJ	5SJ4110-7HG40	HSJ		5SJ4110-8HG40	HSJ		
		13	5SJ4113-6HG40	HSJ	5SJ4113-7HG40	HSJ		5SJ4113-8HG40	HSJ		
		15	5SJ4118-6HG40	HSJ	5SJ4118-7HG40	HSJ		5SJ4118-8HG40	HSJ		
		16	5SJ4116-6HG40	HSJ	5SJ4116-7HG40	HSJ		5SJ4116-8HG40	HSJ		
		20	5SJ4120-6HG40	HSJ	5SJ4120-7HG40	HSJ		5SJ4120-8HG40	HSJ		
		25	5SJ4125-6HG40	HSJ	5SJ4125-7HG40	HSJ		5SJ4125-8HG40	NSJ		
		30	5SJ4130-6HG40	HSJ	5SJ4130-7HG40	HSJ		5SJ4130-8HG40	NSJ		
		32	5SJ4132-6HG40	HSJ	5SJ4132-7HG40	HSJ		5SJ4132-8HG40	NSJ		
	35	5SJ4135-6HG40	HSJ	5SJ4135-7HG40	HSJ		5SJ4135-8HG40	NSJ			
	40	5SJ4140-6HG40	HSJ	5SJ4140-7HG40	HSJ		5SJ4140-8HG40	NSJ			
	45	5SJ4145-6HG40	HSJ	5SJ4145-7HG40	NSJ		5SJ4145-8HG40	NSJ			
	50	5SJ4150-6HG40	HSJ	5SJ4150-7HG40	NSJ		5SJ4150-8HG40	NSJ			
	60	5SJ4160-6HG40	HSJ	5SJ4160-7HG40	NSJ		5SJ4160-8HG40	NSJ			
	63	5SJ4163-6HG40	HSJ	5SJ4163-7HG40	NSJ		5SJ4163-8HG40	NSJ			

1) Interrupting Rating to UL489, AC Max. RMS Symmetrical: Type NSJ = 10kA, Type HSJ = 14 kA.



5SJ Branch Circuit Protection

5SJ4 70 mm mounting depth

Features

5SJ4...-HG41 miniature circuit breakers are designed to comply with UL 489 and CSA 22.2 No. 5-02 standards. They are used in single and multi-pole, branch circuit protection applications up to 240 VAC maximum and 60/125 VDC maximum. Refer to Technical Data (page 16/8) for additional information.

Selection and ordering data

	I_n	Characteristic C Order No.	Interruption Type ¹⁾	List Price \$ 1 item	Characteristic D Order No.	Interruption Type ¹⁾	List Price \$ 1 item	Weight 1 item kg
 <p>1-pole</p> <p>1 2</p>	0.3	5SJ4114-7HG41	HSJ		5SJ4114-8HG41	HSJ		0.155
	0.5	5SJ4105-7HG41	HSJ		5SJ4105-8HG41	HSJ		
	1	5SJ4101-7HG41	HSJ		5SJ4101-8HG41	HSJ		
	1.6	5SJ4115-7HG41	HSJ		5SJ4115-8HG41	HSJ		
	2	5SJ4102-7HG41	HSJ		5SJ4102-8HG41	HSJ		
	3	5SJ4103-7HG41	HSJ		5SJ4103-8HG41	HSJ		
	4	5SJ4104-7HG41	HSJ		5SJ4104-8HG41	HSJ		
	5	5SJ4111-7HG41	HSJ		5SJ4111-8HG41	HSJ		
	6	5SJ4106-7HG41	HSJ		5SJ4106-8HG41	HSJ		
	8	5SJ4108-7HG41	HSJ		5SJ4108-8HG41	HSJ		
	10	5SJ4110-7HG41	HSJ		5SJ4110-8HG41	HSJ		
	13	5SJ4113-7HG41	HSJ		5SJ4113-8HG41	HSJ		
	15	5SJ4118-7HG41	HSJ		5SJ4118-8HG41	HSJ		
	16	5SJ4116-7HG41	HSJ		5SJ4116-8HG41	HSJ		
	20	5SJ4120-7HG41	HSJ		5SJ4120-8HG41	HSJ		
	25	5SJ4125-7HG41	HSJ		5SJ4125-8HG41	NSJ		
	30	5SJ4130-7HG41	HSJ		5SJ4130-8HG41	NSJ		
32	5SJ4132-7HG41	HSJ		5SJ4132-8HG41	NSJ			
35	5SJ4135-7HG41	HSJ		5SJ4135-8HG41	NSJ			
40	5SJ4140-7HG41	HSJ		5SJ4140-8HG41	NSJ			
45	5SJ4145-7HG41	NSJ		5SJ4145-8HG41	NSJ			
50	5SJ4150-7HG41	NSJ		5SJ4150-8HG41	NSJ			
60	5SJ4160-7HG41	NSJ		5SJ4160-8HG41	NSJ			
63	5SJ4163-7HG41	NSJ		5SJ4163-8HG41	NSJ			
 <p>2-pole</p> <p>1 3 2 4</p>	0.3	5SJ4214-7HG41	HSJ		5SJ4214-8HG41	HSJ		0.310
	0.5	5SJ4205-7HG41	HSJ		5SJ4205-8HG41	HSJ		
	1	5SJ4201-7HG41	HSJ		5SJ4201-8HG41	HSJ		
	1.6	5SJ4215-7HG41	HSJ		5SJ4215-8HG41	HSJ		
	2	5SJ4202-7HG41	HSJ		5SJ4202-8HG41	HSJ		
	3	5SJ4203-7HG41	HSJ		5SJ4203-8HG41	HSJ		
	4	5SJ4204-7HG41	HSJ		5SJ4204-8HG41	HSJ		
	5	5SJ4211-7HG41	HSJ		5SJ4211-8HG41	HSJ		
	6	5SJ4206-7HG41	HSJ		5SJ4206-8HG41	HSJ		
	8	5SJ4208-7HG41	HSJ		5SJ4208-8HG41	HSJ		
	10	5SJ4210-7HG41	HSJ		5SJ4210-8HG41	HSJ		
	13	5SJ4213-7HG41	HSJ		5SJ4213-8HG41	HSJ		
	15	5SJ4218-7HG41	HSJ		5SJ4218-8HG41	HSJ		
	16	5SJ4216-7HG41	HSJ		5SJ4216-8HG41	HSJ		
	20	5SJ4220-7HG41	HSJ		5SJ4220-8HG41	HSJ		
	25	5SJ4225-7HG41	HSJ		5SJ4225-8HG41	NSJ		
	30	5SJ4230-7HG41	HSJ		5SJ4230-8HG41	NSJ		
32	5SJ4232-7HG41	HSJ		5SJ4232-8HG41	NSJ			
35	5SJ4235-7HG41	HSJ		5SJ4235-8HG41	NSJ			
40	5SJ4240-7HG41	HSJ		5SJ4240-8HG41	NSJ			
45	5SJ4245-7HG41	NSJ		5SJ4245-8HG41	NSJ			
50	5SJ4250-7HG41	NSJ		5SJ4250-8HG41	NSJ			
60	5SJ4260-7HG41	NSJ		5SJ4260-8HG41	NSJ			
63	5SJ4263-7HG41	NSJ		5SJ4263-8HG41	NSJ			
 <p>3-pole</p> <p>1 3 5 2 4 6</p>	0.3	5SJ4314-7HG41	HSJ		5SJ4314-8HG41	HSJ		0.465
	0.5	5SJ4305-7HG41	HSJ		5SJ4305-8HG41	HSJ		
	1	5SJ4301-7HG41	HSJ		5SJ4301-8HG41	HSJ		
	1.6	5SJ4315-7HG41	HSJ		5SJ4315-8HG41	HSJ		
	2	5SJ4302-7HG41	HSJ		5SJ4302-8HG41	HSJ		
	3	5SJ4303-7HG41	HSJ		5SJ4303-8HG41	HSJ		
	4	5SJ4304-7HG41	HSJ		5SJ4304-8HG41	HSJ		
	5	5SJ4311-7HG41	HSJ		5SJ4311-8HG41	HSJ		
	6	5SJ4306-7HG41	HSJ		5SJ4306-8HG41	HSJ		
	8	5SJ4308-7HG41	HSJ		5SJ4308-8HG41	HSJ		
	10	5SJ4310-7HG41	HSJ		5SJ4310-8HG41	HSJ		
	13	5SJ4313-7HG41	HSJ		5SJ4313-8HG41	HSJ		
	15	5SJ4318-7HG41	HSJ		5SJ4318-8HG41	HSJ		
	16	5SJ4316-7HG41	HSJ		5SJ4316-8HG41	HSJ		
	20	5SJ4320-7HG41	HSJ		5SJ4320-8HG41	HSJ		
	25	5SJ4325-7HG41	HSJ		5SJ4325-8HG41	NSJ		
	30	5SJ4330-7HG41	HSJ		5SJ4330-8HG41	NSJ		
32	5SJ4332-7HG41	HSJ		5SJ4332-8HG41	NSJ			
35	5SJ4335-7HG41	HSJ		5SJ4335-8HG41	NSJ			
40	5SJ4340-7HG41	HSJ		5SJ4340-8HG41	NSJ			
45	5SJ4345-7HG41	NSJ		5SJ4345-8HG41	NSJ			
50	5SJ4350-7HG41	NSJ		5SJ4350-8HG41	NSJ			
60	5SJ4360-7HG41	NSJ		5SJ4360-8HG41	NSJ			
63	5SJ4363-7HG41	NSJ		5SJ4363-8HG41	NSJ			

¹⁾ Interrupting Rating to UL489, AC Max. RMS Symmetrical: Type NSJ = 10kA, Type HSJ = 14 kA.







5SJ Branch Circuit Protection

5SJ4 70 mm mounting depth

Features

5SJ4...-HG42 miniature circuit breakers are designed to comply with UL 489 and CSA 22.2 No. 5-02 standards. They are used in single and multi-pole, branch circuit protection and feeder applications up to 480Y/277 VAC maximum and 60/125 VDC maximum. Refer to Technical Data (page 16/8) for additional information.

Selection and ordering data

	I_n	Characteristic C Order No.	Interruption Type ¹⁾	List Price \$ 1 item	Characteristic D Order No.	Interruption Type ¹⁾	List Price \$ 1 item	Weight 1 item kg
	<p>1-pole</p> 	0.3	5SJ4114-7HG42	NSJ	5SJ4114-8HG42	NSJ	0.155	
		0.5	5SJ4105-7HG42	NSJ	5SJ4105-8HG42	NSJ		
		1	5SJ4101-7HG42	NSJ	5SJ4101-8HG42	NSJ		
		1.6	5SJ4115-7HG42	NSJ	5SJ4115-8HG42	NSJ		
		2	5SJ4102-7HG42	NSJ	5SJ4102-8HG42	NSJ		
		3	5SJ4103-7HG42	NSJ	5SJ4103-8HG42	NSJ		
		4	5SJ4104-7HG42	NSJ	5SJ4104-8HG42	NSJ		
		5	5SJ4111-7HG42	NSJ	5SJ4111-8HG42	NSJ		
		6	5SJ4106-7HG42	NSJ	5SJ4106-8HG42	NSJ		
		8	5SJ4108-7HG42	NSJ	5SJ4108-8HG42	NSJ		
		10	5SJ4110-7HG42	NSJ	5SJ4110-8HG42	NSJ		
		13	5SJ4113-7HG42	NSJ	5SJ4113-8HG42	NSJ		
		15	5SJ4118-7HG42	NSJ	5SJ4118-8HG42	NSJ		
		16	5SJ4116-7HG42	NSJ	5SJ4116-8HG42	NSJ		
		20	5SJ4120-7HG42	NSJ	5SJ4120-8HG42	NSJ		
		25	5SJ4125-7HG42	NSJ	5SJ4125-8HG42	NSJ		
30	5SJ4130-7HG42	NSJ	5SJ4130-8HG42	NSJ				
32	5SJ4132-7HG42	NSJ	5SJ4132-8HG42	NSJ				
35	5SJ4135-7HG42	NSJ	—	—				
40	5SJ4140-7HG42	NSJ	—	—				
	<p>2-pole</p> 	0.3	5SJ4214-7HG42	NSJ	5SJ4214-8HG42	NSJ	0.310	
		0.5	5SJ4205-7HG42	NSJ	5SJ4205-8HG42	NSJ		
		1	5SJ4201-7HG42	NSJ	5SJ4201-8HG42	NSJ		
		1.6	5SJ4215-7HG42	NSJ	5SJ4215-8HG42	NSJ		
		2	5SJ4202-7HG42	NSJ	5SJ4202-8HG42	NSJ		
		3	5SJ4203-7HG42	NSJ	5SJ4203-8HG42	NSJ		
		4	5SJ4204-7HG42	NSJ	5SJ4204-8HG42	NSJ		
		5	5SJ4211-7HG42	NSJ	5SJ4211-8HG42	NSJ		
		6	5SJ4206-7HG42	NSJ	5SJ4206-8HG42	NSJ		
		8	5SJ4208-7HG42	NSJ	5SJ4208-8HG42	NSJ		
		10	5SJ4210-7HG42	NSJ	5SJ4210-8HG42	NSJ		
		13	5SJ4213-7HG42	NSJ	5SJ4213-8HG42	NSJ		
		15	5SJ4218-7HG42	NSJ	5SJ4218-8HG42	NSJ		
		16	5SJ4216-7HG42	NSJ	5SJ4216-8HG42	NSJ		
		20	5SJ4220-7HG42	NSJ	5SJ4220-8HG42	NSJ		
		25	5SJ4225-7HG42	NSJ	5SJ4225-8HG42	NSJ		
30	5SJ4230-7HG42	NSJ	5SJ4230-8HG42	NSJ				
32	5SJ4232-7HG42	NSJ	5SJ4232-8HG42	NSJ				
35	5SJ4235-7HG42	NSJ	—	—				
40	5SJ4240-7HG42	NSJ	—	—				
	<p>3-pole</p> 	0.3	5SJ4314-7HG42	NSJ	5SJ4314-8HG42	NSJ	0.465	
		0.5	5SJ4305-7HG42	NSJ	5SJ4305-8HG42	NSJ		
		1	5SJ4301-7HG42	NSJ	5SJ4301-8HG42	NSJ		
		1.6	5SJ4315-7HG42	NSJ	5SJ4315-8HG42	NSJ		
		2	5SJ4302-7HG42	NSJ	5SJ4302-8HG42	NSJ		
		3	5SJ4303-7HG42	NSJ	5SJ4303-8HG42	NSJ		
		4	5SJ4304-7HG42	NSJ	5SJ4304-8HG42	NSJ		
		5	5SJ4311-7HG42	NSJ	5SJ4311-8HG42	NSJ		
		6	5SJ4306-7HG42	NSJ	5SJ4306-8HG42	NSJ		
		8	5SJ4308-7HG42	NSJ	5SJ4308-8HG42	NSJ		
		10	5SJ4310-7HG42	NSJ	5SJ4310-8HG42	NSJ		
		13	5SJ4313-7HG42	NSJ	5SJ4313-8HG42	NSJ		
		15	5SJ4318-7HG42	NSJ	5SJ4318-8HG42	NSJ		
		16	5SJ4316-7HG42	NSJ	5SJ4316-8HG42	NSJ		
		20	5SJ4320-7HG42	NSJ	5SJ4320-8HG42	NSJ		
		25	5SJ4325-7HG42	NSJ	5SJ4325-8HG42	NSJ		
30	5SJ4330-7HG42	NSJ	5SJ4330-8HG42	NSJ				
32	5SJ4332-7HG42	NSJ	5SJ4332-8HG42	NSJ				
35	5SJ4335-7HG42	NSJ	—	—				
40	5SJ4340-7HG42	NSJ	—	—				

1) Interrupting Rating to UL489, AC Max. RMS Symmetrical: Type NSJ = 10kA.













5SJ Branch Circuit Protection

Additional components for 5SJ4 Branch Circuit Protection

Features

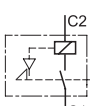
- For use with the **5SJ4...-HG4** family of miniature circuit breakers
- UL Listed and CSA Certified to UL 489

Selection and ordering data

			Order No.	List Price \$	Weight 1 item	
			1 item		kg	
	Auxiliary switches (AS)					
		1 NO + 1 NC	5ST 3010-0HG		0.050	
		2 NO	5ST 3011-0HG			
		2 NC	5ST 3012-0HG			
	Fault signal contacts (FC)					
		1 NO + 1 NC	5ST 3020-0HG		0.050	
		2 NO	5ST 3021-0HG			
		2 NC	5ST 3022-0HG			
	Shunt trip (ST)					
		110 - 480 VAC	5ST 3030-0HG		0.098	
		24 - 60 V AC/DC	5ST 3031-0HG		0.098	
	Busbars					
	Fixed lengths, cannot be cut¹⁾	Length				
	1-Pole	For 6 MCBs For 12 MCBs For 18 MCBs	100 mm 205 mm 310 mm	5ST 3663-0HG 5ST 3663-1HG 5ST 3663-2HG	0.056 0.112 0.170	
	2-Pole	For 3 MCBs For 6 MCBs For 9 MCBs	100 mm 205 mm 310 mm	5ST 3664-0HG 5ST 3664-1HG 5ST 3664-2HG	0.065 0.137 0.211	
	3-Pole	For 2 MCBs For 4 MCBs For 6 MCBs	100 mm 205 mm 310 mm	5ST 3665-0HG 5ST 3665-1HG 5ST 3665-2HG	0.067 0.155 0.243	
		Connection terminals				
		Infeed - MCBs	35 mm ²	5ST 3666-0HG	0.033	
		Infeed - busbars	50 mm ²	5ST 3666-2HG	0.034	
		Touch protection covers²⁾	3 x 1 pin	5ST 3666-1HG	0.003	

1) Cut-able BusBars Availability to be announced.

2) Always cover all exposed terminals with touch protection covers 5ST3666-1HG.

Technical data

		5SJ41...-HG40	5SJ4...-HG41	5SJ4...-HG42
Standards Certifications		EN 60898; EN 60947-2; UL 489; CSA C22.2 No. 5-02 CE; cULus, UL File No. E243414		
Tripping characteristic		B, C, D	C, D	
Number of poles		1	1, 2 & 3	
Operating voltage	Min. V AC/DC	24		
- IEC 60898	Max. V DC/pole	60		
	Max. V AC	440		
- UL 489 and CSA C22.2 No. 5-02	Max. V AC	240 Same Polarity	240	480Y/277
	V DC/1P	60	60	60
	V DC/2P, 3P	—	125	125
Interrupting rating ¹⁾		10		
- I _{cn} to IEC 60898-1	kA AC	Type NSJ: 10kA		
- UL 489 and CSA C22.2 No. 5-02		Type HSJ: 14kA		
AC: Max. RMS Symmetrical	kA AC	Type NSJ: 10kA		
Touch protection to EN 50274		Yes		
Degree of protection to EN 60529		IP20, with connected conductors		
CFC and silicone free		Yes		
Mounting		On standard mounting rail (DIN 35 mm)		
Device depth	mm	70		
Terminals		Yes		
- Identical screw terminals on both line and load sides		31		
- Terminal tightening torque	lb. in.	3.5		
	Nm			
Conductor cross sections	mm ²	Solid and Stranded: 0.75 to 35		
	mm ²	Finely Stranded, with end sleeve: 0.75 to 25		
	AWG	14 to 4, 60/75°C, Cu Only		
Calibration Base	°C	40 (UL 489) 30 (EN 60898)		
Average service life, with rated load		20,000 actuations		
Ambient temperature	°C	-25 to 45, occasionally +55, max. 95% humidity		
Storage Temperature	°C	-40 to +75		
Resistance to vibration to IEC 60068-2-6	m/s ²	60 at 10 Hz to 150 Hz		

1) See Selection and ordering data for specific device interrupting rating

Busbar & Connecting Terminals

Material Version		Busbars		Connecting Terminals	
		5ST3663 5ST3664 5ST3665		5ST3666-0HG	5ST3666-2HG
Standards Certifications		UL 489 UL Listed, File No. E243414			
Operating voltage		690			
- IEC 60898	VAC	480Y/277 and 240			
- UL 489	VAC				
Rated current to 40°C	A	115			
Busbar cross section	mm ²	16 (Copper)			
Conductor cross sections	Solid and Stranded mm ²	-	2.5 to 35	2.5 to 50	
	AWG	-	14 to 2	14 to 1	
Terminal tightening torque	lb. in.	-	30	30	
	Nm	-	3.3	3.3	
Temperature Resistance	°C	200 - UL 94-V0/0.4mm			

Technical data

Auxiliary Switch (AS), Fault Signal Contacts (FC) and Shunt Trip (ST)

Material Version	AS 5ST301.-0HG	FC 5ST302.-0HG	ST 5ST3030-0HG	5ST3032-0HG
Standards	UL 489; CSA C22.2 No. 5-02 IEC/EN 62019, IEC/EN 60947-5-1		IEC/EN 60947-1	
Certifications	CE, UL 489, CSA, UL File No. E321559			
Rated voltages/load	IEC AC V 400 230 AC A 2 6 (NC:AC13, NO: AC14) DC V 220 110 60 24 DC A 1 1 3 6 (DC 13)		110 to 415 - 110 -	24 to 60 - 24 to 60 -
Contact load	UL AC V 480 277 240 120 AC A 1.5 3 4 6 DC V 125 60 DC A 1 3		110 to 480 - -	24 to 60 - 24 to 60 -
Conductor cross-sections	AWG mm ²	22 ... 14 0.5 ... 2.5	22 ... 14 0.5 ... 2.5	0.5 ... 2.5
Terminals - terminal tightening torque	Nm lb/in.	0.5 max. 4.5	0.8 max. 6.8	0.8 max. 6.8

Applications

Auxiliary Switch (AS), Fault Signal Contact (FC) and Shunt Trip (ST) accessories are used with 5SJ4...-HG4. miniature circuit breakers (CB) and are mounted to the right of them.

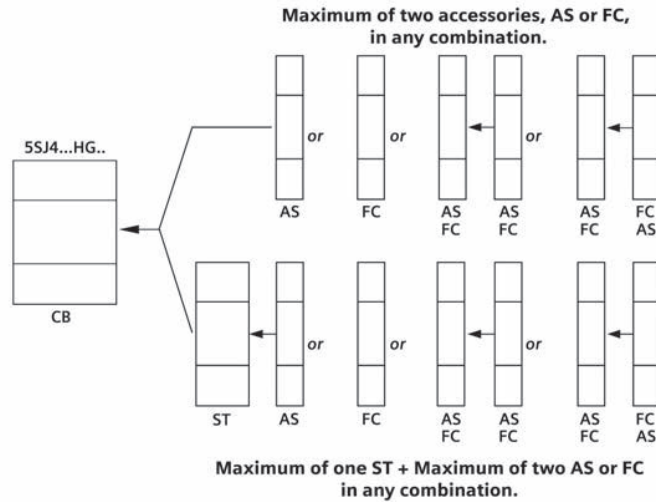

Dimensions

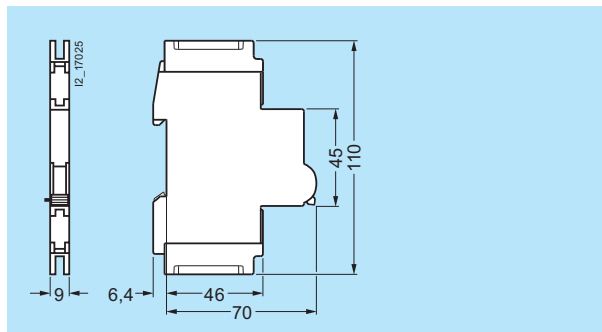

5ST3 010-0HG 5ST3 011-0HG 5ST3 012-0HG
5ST3 020-0HG 5ST3 021-0HG 5ST3 022-0HG

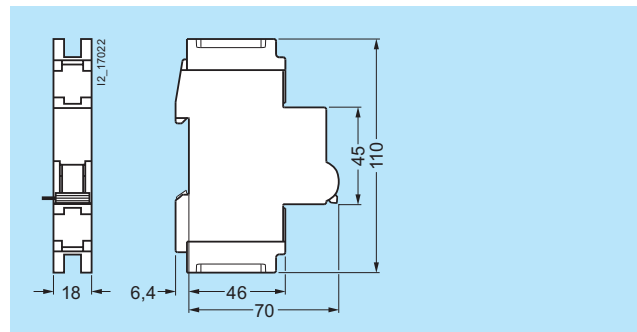

5ST3 030-0HG 5ST3 031-0HG

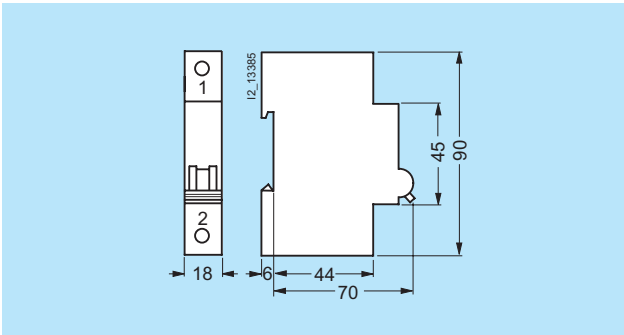

5SJ4...-HG40

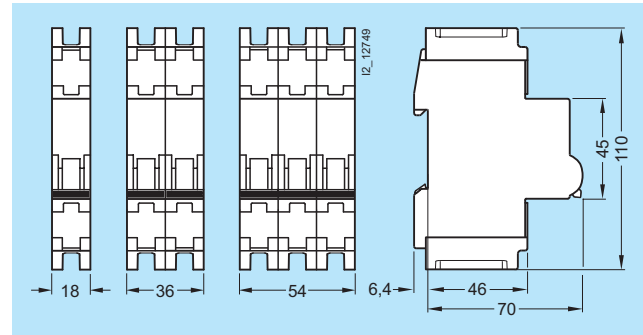

5SJ4...-HG41

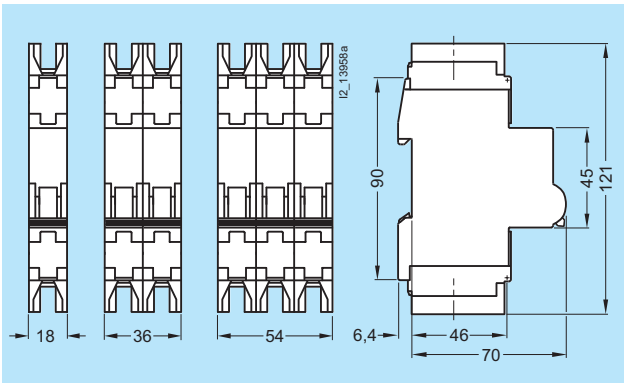

5SJ4...-HG42

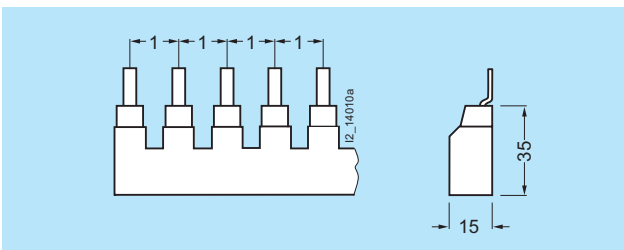

5ST3 663-0HG 5ST3 664-0HG 5ST3 665-0HG
 5ST3 663-1HG 5ST3 664-1HG 5ST3 665-1HG
 5ST3 663-2HG 5ST3 664-2HG 5ST3 665-2HG

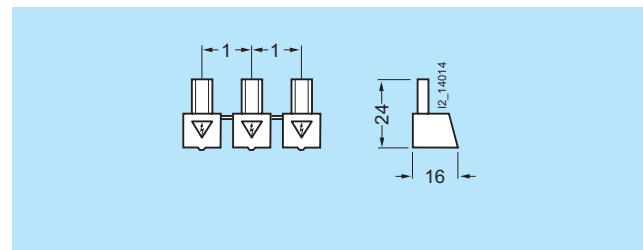

5ST3 666-1HG

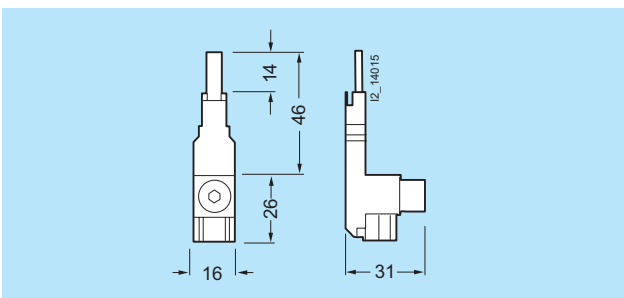

5ST3 666-0HG

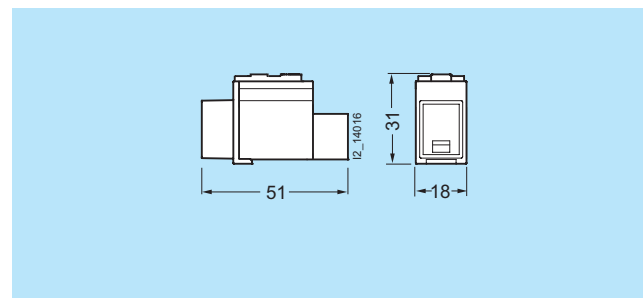

5ST3 666-2HG

Application

Siemens' UL 1077 Supplementary Protectors are designed to provide additional protection along with a branch circuit protection device. Since our Supplementary protectors are made to trip faster than a standard UL 489 Circuit Breaker they are able to provide additional protection for more sensitive devices inside the panel. Supplementary protectors can be used in a number of industrial applications such as to provide selectivity for multiple motor control circuits on the secondary side of a control transformer or power supply by allowing the user to quickly find the problem circuit should a fault occur without having to shut down all of the other control circuits. Supplementary protectors may also be used as a local disconnecting means inside the panel when a branch circuit protection device is already present.

Always remember to follow the National Electric code when wiring your panel for applications within the United States.

Design

Supplementary protectors are equipped with a delayed overload/time-dependent thermal release (thermal bimetal) for low overcurrents and with an instantaneous electromagnetic release for high overload and short-circuit currents.

The special contact materials used virtually guarantee a long service life and offer a high degree of protection against contact welding.

Mode of operation

Thanks to the extremely fast contact separation in cases of failures and the rapid quenching of the arc consequently generated in the arcing chamber, supplementary protectors assure a safe and current-limiting off-switching.

The permissible limit- I^2t -values of the energy limitation class 3 specified in EN 60 898 are generally undercut. This guarantees an excellent selectivity towards upstream overcurrent protection devices.

Features

- High rated breaking capacity of up to 10,000 A acc. to EN 60 898 / up to 15 kA acc. to EN 60 947-2
- Excellent current limiting and selectivity characteristics
- Tripping characteristic A, B, C and D
- Terminals offer protection against contact with fingers or the back of the hand acc. to the German accident prevention regulations VBG 4/ BGV A2
- Combined terminals enable a simultaneous connection of busbars and feeder cables
- Uniform components that can be quickly mounted individually, thanks to their snap-on technique
- The handle locking device virtually prevents any unauthorized operation of the handle

Features of 5SY

- Rapid connection of the feeder cable in front of the busbar
- Identical terminals at both sides for an optional infeed from the top or the bottom
- No tool required for mounting or dismounting
- Supports a fast and comfortable removal from the assembly
- Trip indication

Features of 5SP4

- Disconnection characteristics acc. to EN 60947-3 (DIN VDE 0660 Part 107)
- Main switch characteristics acc. to EN 60 204-1
- Can be screwed onto bases
- Separate switch position indication.

Device markings

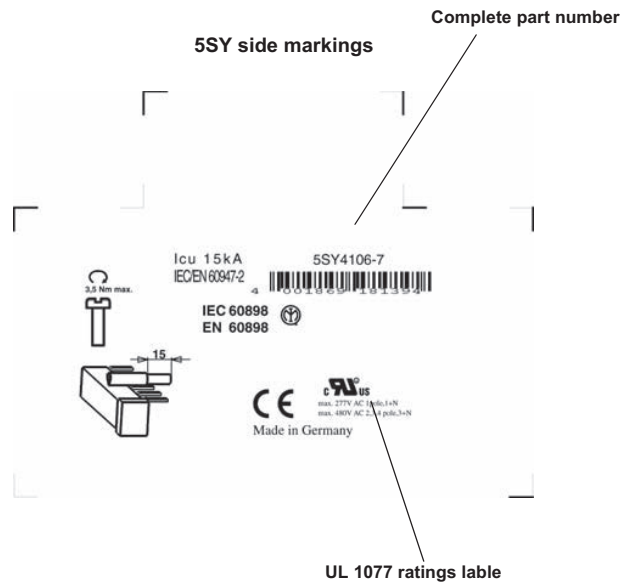
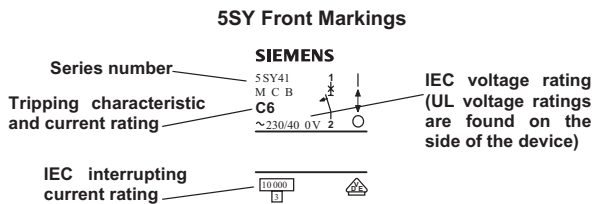

Overview

Features of 5SY supplementary protectors

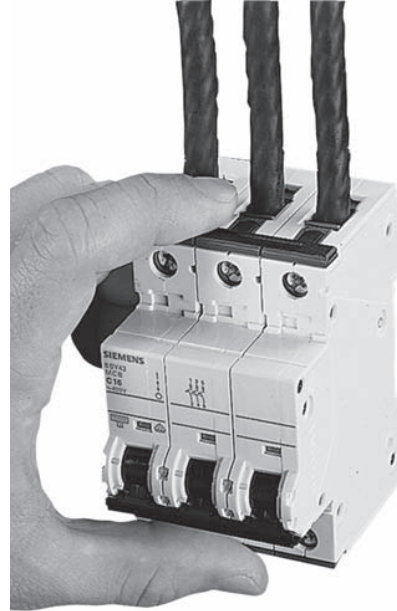
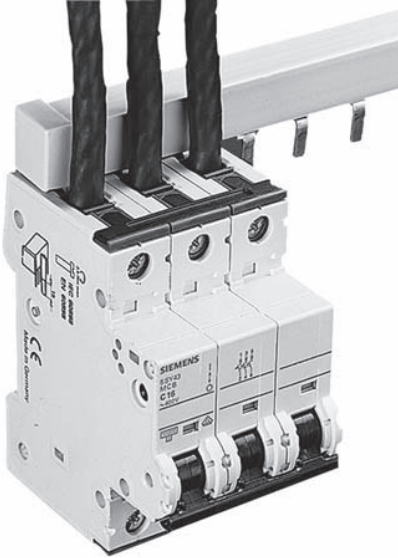

Easier, faster, enlarged wiring space

- Identical top and bottom terminals
- Connection of incoming cables vis-à-vis of the busbar
- Enlarged and easily accessible wiring space for the feeder cables
- Comfortable insertion of the incoming cables into the terminal
- Defined, visible and controllable connection of the feeder cables
- Universal infeed with top and bottom busbar mounting options.

Protection against contact with clear advantages

- Integrated movable terminal covers located at the feeder cable input
- The terminals are completely closed when screws are fully tightened
- Effective protection against contact, also when the device is fully grabbed

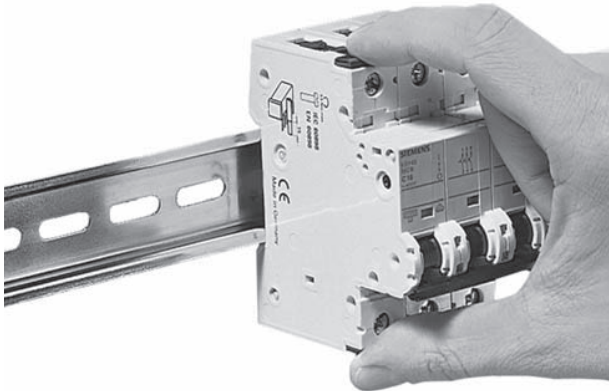

Flexible and no use of tools required

- Manually operable quick-assembly and disassembly systems requiring no use of tools
- Fast assembly and disassembly of 5SY supplementary protectors to and from the standard mounting rail.
- All devices can be easily and comfortably replaced at any time.

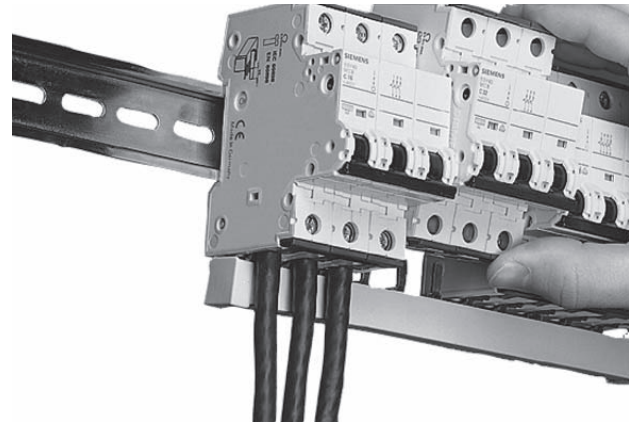

Removal from the assembly

Thanks to the combination of the various features stated above, 5SY supplementary protectors can be easily and rapidly removed from the assembly when circuits need to be changed - with these devices, removal of the busbar is no longer necessary.







5SY4 Supplementary Protection

5SY4 70 mm mounting depth

Features

All 5SY4 designs have been certified to **UL 1077 and CSA 22.2 No. 235-M 89** and can therefore be used as “supplementary protectors” for applications up to 277 V AC (1-pole and 1-pole + N designs) and 480 V AC (2-pole, 3-pole, 3-pole + N and 4-pole designs).

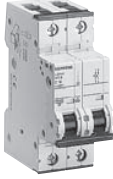
Selection and ordering data

	I_n	MW	Characteristic A		Characteristic B		Characteristic C		Characteristic D		Weight 1 item kg	
			Order No.	List Price \$ 1 item	Order No.	List Price \$ 1 item	Order No.	List Price \$ 1 item	Order No.	List Price \$ 1 item		
 <p>1-pole</p> 	A											
	0.3	1	—	—	—	—	5SY4 114-7	—	5SY4 114-8	—	0.165	
	0.5		5SY4 105-5	—	—	—	5SY4 105-7	—	5SY4 105-8	—		
	1		5SY4 101-5	—	—	—	5SY4 101-7	—	5SY4 101-8	—		
	1.6		5SY4 115-5	—	—	—	5SY4 115-7	—	5SY4 115-8	—		
	2		5SY4 102-5	—	5SY4 102-6	—	5SY4 102-7	—	5SY4 102-8	—		
	3		5SY4 103-5	—	—	—	5SY4 103-7	—	5SY4 103-8	—		
	4		5SY4 104-5	—	5SY4 104-6	—	5SY4 104-7	—	5SY4 104-8	—		
	5		—	—	—	—	5SY4 111-7	—	—	—		
	6		5SY4 106-5	—	5SY4 106-6	—	5SY4 106-7	—	5SY4 106-8	—		
	8		5SY4 108-5	—	—	—	5SY4 108-7	—	5SY4 108-8	—		
	10		5SY4 110-5	—	5SY4 110-6	—	5SY4 110-7	—	5SY4 110-8	—		
	13		5SY4 113-5	—	5SY4 113-6	—	5SY4 113-7	—	5SY4 113-8	—		
	15		—	—	—	—	5SY4 118-7	—	—	—		
	16		5SY4 116-5	—	5SY4 116-6	—	5SY4 116-7	—	5SY4 116-8	—		
	20		5SY4 120-5	—	5SY4 120-6	—	5SY4 120-7	—	5SY4 120-8	—		
	25		5SY4 125-5	—	5SY4 125-6	—	5SY4 125-7	—	5SY4 125-8	—		
	30		—	—	—	—	5SY4 130-7	—	—	—		
	32		5SY4 132-5	—	5SY4 132-6	—	5SY4 132-7	—	5SY4 132-8	—		
35		—	—	—	—	5SY4 135-7	—	—	—			
40		5SY4 140-5	—	5SY4 140-6	—	5SY4 140-7	—	5SY4 140-8	—			
45		—	—	—	—	5SY4 145-7	—	—	—			
50		5SY4 150-5	—	5SY4 150-6	—	5SY4 150-7	—	5SY4 150-8	—			
60		—	—	—	—	5SY4 160-7	—	—	—			
63		5SY4 163-5	—	5SY4 163-6	—	5SY4 163-7	—	5SY4 163-8	—			
 <p>1-pole + N</p> 	0.3	2	—	—	—	—	5SY4 514-7	—	5SY4 514-8	—	0.330	
	0.5		—	—	—	—	5SY4 505-7	—	5SY4 505-8	—		
	1		5SY4 501-5	—	—	—	5SY4 501-7	—	5SY4 501-8	—		
	1.6		5SY4 515-5	—	—	—	5SY4 515-7	—	5SY4 515-8	—		
	2		5SY4 502-5	—	—	—	5SY4 502-7	—	5SY4 502-8	—		
	3		5SY4 503-5	—	—	—	5SY4 503-7	—	5SY4 503-8	—		
	4		5SY4 504-5	—	—	—	5SY4 504-7	—	5SY4 504-8	—		
	6		5SY4 506-5	—	5SY4 506-6	—	5SY4 506-7	—	5SY4 506-8	—		
	8		5SY4 508-5	—	—	—	5SY4 508-7	—	5SY4 508-8	—		
	10		5SY4 510-5	—	5SY4 510-6	—	5SY4 510-7	—	5SY4 510-8	—		
	13		5SY4 513-5	—	5SY4 513-6	—	5SY4 513-7	—	5SY4 513-8	—		
	16		5SY4 516-5	—	5SY4 516-6	—	5SY4 516-7	—	5SY4 516-8	—		
	20		5SY4 520-5	—	5SY4 520-6	—	5SY4 520-7	—	5SY4 520-8	—		
	25		5SY4 525-5	—	5SY4 525-6	—	5SY4 525-7	—	5SY4 525-8	—		
32		5SY4 532-5	—	5SY4 532-6	—	5SY4 532-7	—	5SY4 532-8	—			
40		5SY4 540-5	—	5SY4 540-6	—	5SY4 540-7	—	5SY4 540-8	—			
50		5SY4 550-5	—	5SY4 550-6	—	5SY4 550-7	—	5SY4 550-8	—			
63		5SY4 563-5	—	5SY4 563-6	—	5SY4 563-7	—	5SY4 563-8	—			
 <p>2-pole</p> 	0.3	2	—	—	—	—	5SY4 214-7	—	5SY4 214-8	—	0.330	
	0.5		5SY4 205-5	—	—	—	—	5SY4 205-7	—	5SY4 205-8	—	
	1		5SY4 201-5	—	—	—	—	5SY4 201-7	—	5SY4 201-8	—	
	1.6		5SY4 215-5	—	—	—	—	5SY4 215-7	—	5SY4 215-8	—	
	2		5SY4 202-5	—	—	—	—	5SY4 202-7	—	5SY4 202-8	—	
	3		5SY4 203-5	—	—	—	—	5SY4 203-7	—	5SY4 203-8	—	
	4		5SY4 204-5	—	—	—	—	5SY4 204-7	—	5SY4 204-8	—	
	5		—	—	—	—	5SY4 211-7	—	—	—		
	6		5SY4 206-5	—	5SY4 206-6	—	—	5SY4 206-7	—	5SY4 206-8	—	
	8		5SY4 208-5	—	—	—	—	5SY4 208-7	—	5SY4 208-8	—	
	10		5SY4 210-5	—	5SY4 210-6	—	—	5SY4 210-7	—	5SY4 210-8	—	
	13		5SY4 213-5	—	5SY4 213-6	—	—	5SY4 213-7	—	5SY4 213-8	—	
	15		—	—	—	—	5SY4 218-7	—	—	—		
	16		5SY4 216-5	—	5SY4 216-6	—	—	5SY4 216-7	—	5SY4 216-8	—	
	20		5SY4 220-5	—	5SY4 220-6	—	—	5SY4 220-7	—	5SY4 220-8	—	
	25		5SY4 225-5	—	5SY4 225-6	—	—	5SY4 225-7	—	5SY4 225-8	—	
	30		—	—	—	—	5SY4 230-7	—	—	—		
	32		5SY4 232-5	—	5SY4 232-6	—	—	5SY4 232-7	—	5SY4 232-8	—	
35		—	—	—	—	5SY4 235-7	—	—	—			
40		5SY4 240-5	—	5SY4 240-6	—	—	5SY4 240-7	—	5SY4 240-8	—		
45		—	—	—	—	5SY4 245-7	—	—	—			
50		5SY4 250-5	—	5SY4 250-6	—	—	5SY4 250-7	—	5SY4 250-8	—		
60		—	—	—	—	5SY4 260-7	—	—	—			
63		5SY4 263-5	—	5SY4 263-6	—	—	5SY4 263-7	—	5SY4 263-8	—		







1 MW = modular width of 18 mm. Depth = 70 mm.

5SY4 Supplementary Protection

5SY4 70 mm mounting depth

Selection and ordering data

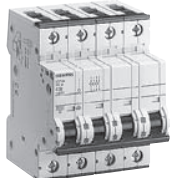
All 5SY4 designs have been certified acc. to **UL 1077 and CSA 22.2 No. 235-M 89** and can therefore be used as "supplementary protectors" for applications of up to 277 V AC (1-pole and 1-pole + N designs) and 480 V AC (2-pole, 3-pole, 3-pole + N and 4-pole designs).

	I_n	MW	Characteristic A		Characteristic B		Characteristic C		Characteristic D		Weight 1 item kg
			Order No.	List Price \$ 1 item	Order No.	List Price \$ 1 item	Order No.	List Price \$ 1 item	Order No.	List Price \$ 1 item	
 <p>3-pole</p> 	A										
		0.3	—	—	—	—	5SY4 314-7	—	5SY4 314-8	—	0.495
		0.5	5SY4 305-5	—	—	—	5SY4 305-7	—	5SY4 305-8	—	
		1	5SY4 301-5	—	—	—	5SY4 301-7	—	5SY4 301-8	—	
		1.6	5SY4 315-5	—	—	—	5SY4 315-7	—	5SY4 315-8	—	
		2	5SY4 302-5	—	—	—	5SY4 302-7	—	5SY4 302-8	—	
		3	5SY4 303-5	—	—	—	5SY4 303-7	—	5SY4 303-8	—	
		4	5SY4 304-5	—	—	—	5SY4 304-7	—	5SY4 304-8	—	
		5	—	—	—	—	5SY4 311-7	—	—	—	
		6	5SY4 306-5	—	5SY4 306-6	—	5SY4 306-7	—	5SY4 306-8	—	
		8	5SY4 308-5	—	—	—	5SY4 308-7	—	5SY4 308-8	—	
		10	5SY4 310-5	—	5SY4 310-6	—	5SY4 310-7	—	5SY4 310-8	—	
		13	5SY4 313-5	—	5SY4 313-6	—	5SY4 313-7	—	5SY4 313-8	—	
		15	—	—	—	—	5SY4 318-7	—	—	—	
		16	5SY4 316-5	—	5SY4 316-6	—	5SY4 316-7	—	5SY4 316-8	—	
		20	5SY4 320-5	—	5SY4 320-6	—	5SY4 320-7	—	5SY4 320-8	—	
		25	5SY4 325-5	—	5SY4 325-6	—	5SY4 325-7	—	5SY4 325-8	—	
		30	—	—	—	—	5SY4 330-7	—	—	—	
	32	5SY4 332-5	—	5SY4 332-6	—	5SY4 332-7	—	5SY4 332-8	—		
	35	—	—	—	—	5SY4 335-7	—	—	—		
	40	5SY4 340-5	—	5SY4 340-6	—	5SY4 340-7	—	5SY4 340-8	—		
	45	—	—	—	—	5SY4 345-7	—	—	—		
	50	5SY4 350-5	—	5SY4 350-6	—	5SY4 350-7	—	5SY4 350-8	—		
	60	—	—	—	—	5SY4 360-7	—	—	—		
	63	5SY4 363-5	—	5SY4 363-6	—	5SY4 363-7	—	5SY4 363-8	—		
 <p>3-pole + N</p> 		0.3	—	—	—	5SY4 614-7	—	5SY4 614-8	—	0.660	
		0.5	—	—	—	5SY4 605-7	—	5SY4 605-8	—		
		1	5SY4 601-5	—	—	—	5SY4 601-7	—	5SY4 601-8		—
		1.6	5SY4 615-5	—	—	—	5SY4 615-7	—	5SY4 615-8		—
		2	5SY4 602-5	—	—	—	5SY4 602-7	—	5SY4 602-8		—
		3	5SY4 603-5	—	—	—	5SY4 603-7	—	5SY4 603-8		—
		4	5SY4 604-5	—	—	—	5SY4 604-7	—	5SY4 604-8		—
		6	5SY4 606-5	—	5SY4 606-6	—	5SY4 606-7	—	5SY4 606-8		—
		8	5SY4 608-5	—	—	—	5SY4 608-7	—	5SY4 608-8		—
		10	5SY4 610-5	—	5SY4 610-6	—	5SY4 610-7	—	5SY4 610-8		—
		13	5SY4 613-5	—	5SY4 613-6	—	5SY4 613-7	—	5SY4 613-8		—
		16	5SY4 616-5	—	5SY4 616-6	—	5SY4 616-7	—	5SY4 616-8		—
		20	5SY4 620-5	—	5SY4 620-6	—	5SY4 620-7	—	5SY4 620-8		—
		25	5SY4 625-5	—	5SY4 625-6	—	5SY4 625-7	—	5SY4 625-8		—
		32	5SY4 632-5	—	5SY4 632-6	—	5SY4 632-7	—	5SY4 632-8		—
		40	5SY4 640-5	—	5SY4 640-6	—	5SY4 640-7	—	5SY4 640-8		—
		50	5SY4 650-5	—	5SY4 650-6	—	5SY4 650-7	—	5SY4 650-8		—
		63	5SY4 663-5	—	5SY4 663-6	—	5SY4 663-7	—	5SY4 663-8		—
 <p>4-pole</p> 		0.3	—	—	—	5SY4 414-7	—	5SY4 414-8	—	0.660	
		0.5	—	—	—	—	5SY4 405-7	—	5SY4 405-8		—
		1	5SY4 401-5	—	—	—	5SY4 401-7	—	5SY4 401-8		—
		1.6	5SY4 415-5	—	—	—	5SY4 415-7	—	5SY4 415-8		—
		2	5SY4 402-5	—	—	—	5SY4 402-7	—	5SY4 402-8		—
		3	5SY4 403-5	—	—	—	5SY4 403-7	—	5SY4 403-8		—
		4	5SY4 404-5	—	—	—	5SY4 404-7	—	5SY4 404-8		—
		6	5SY4 406-5	—	5SY4 406-6	—	5SY4 406-7	—	5SY4 406-8		—
		8	5SY4 408-5	—	—	—	5SY4 408-7	—	5SY4 408-8		—
		10	5SY4 410-5	—	5SY4 410-6	—	5SY4 410-7	—	5SY4 410-8		—
		13	5SY4 413-5	—	5SY4 413-6	—	5SY4 413-7	—	5SY4 413-8		—
		16	5SY4 416-5	—	5SY4 416-6	—	5SY4 416-7	—	5SY4 416-8		—
		20	5SY4 420-5	—	5SY4 420-6	—	5SY4 420-7	—	5SY4 420-8		—
		25	5SY4 425-5	—	5SY4 425-6	—	5SY4 425-7	—	5SY4 425-8		—
		32	5SY4 432-5	—	5SY4 432-6	—	5SY4 432-7	—	5SY4 432-8		—
		40	5SY4 440-5	—	5SY4 440-6	—	5SY4 440-7	—	5SY4 440-8		—
		50	5SY4 450-5	—	5SY4 450-6	—	5SY4 450-7	—	5SY4 450-8		—
		63	5SY4 463-5	—	5SY4 463-6	—	5SY4 463-7	—	5SY4 463-8		—

1 MW = modular width of 18 mm.
Depth = 70 mm.

5SY6 Supplementary Protection

5SY6 70 mm mounting depth

Features

All 5SY6 designs have been certified to **UL 1077 and CSA 22.2 No. 235-M 89** and can therefore be used as “supplementary protectors” for applications up to 277 V AC (1-pole and 1-pole + N designs) and 480 V AC (2-pole, 3-pole, 3-pole + N and 4-pole designs). The only difference between 5SY4 and 5SY6 is the IEC 60898-1 Interrupting Rating. 5SY4 has 10kA and 5SY6 has 6kA Interrupting rating according to IEC 60898-1. However, UL Interrupting ratings are the same for 5SY4 and 5SY6.

Selection and ordering data

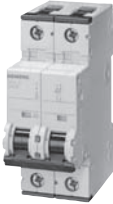
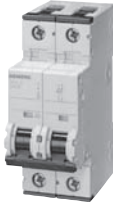
	I_n	Mounting width	DT	Characteristic B			Characteristic C			PU (UNIT, SET, M)	PS/ P. unit	PG	Weight per PU approx. kg
				Order No.	Price per PU	PG DT	Order No.	Price per PU	PG				
	A	MW ¹⁾											
MCBs 6000 A 1-Pole, 230/400 V AC 	0.3	1	—				5SY6 114-7		1	1 unit	001	0.167	
	0.5		—				5SY6 105-7		1	1/12 units	001	0.165	
	1		—				5SY6 101-7		1	1/12 units	001	0.164	
	1.6		—				5SY6 115-7		1	1 unit	001	0.162	
	2		5SY6 102-6		001	▶	5SY6 102-7		1	1/12 units	001	0.153	
	3		—				5SY6 103-7		1	1/12 units	001	0.145	
	4		5SY6 104-6		001	▶	5SY6 104-7		1	1/12 units	001	0.160	
	5		—				5SY6 111-7		1	1/12 units	001	0.160	
	6		▶ 5SY6 106-6		001	▶	5SY6 106-7		1	1/12 units	001	0.160	
	8		—				5SY6 108-7		1	1/12 units	001	0.158	
	10		▶ 5SY6 110-6		001	▶	5SY6 110-7		1	1/12 units	001	0.158	
	13		5SY6 113-6		001		5SY6 113-7		1	1/12 units	001	0.148	
	15		—				5SY6 118-7		1	1/12 units	001	0.160	
	16		▶ 5SY6 116-6		001	▶	5SY6 116-7		1	1/12 units	001	0.158	
	20		5SY6 120-6		001		5SY6 120-7		1	1/12 units	001	0.162	
	25		5SY6 125-6		001		5SY6 125-7		1	1/12 units	001	0.163	
	30		—				5SY6 130-7		1	1/12 units	001	0.160	
32		5SY6 132-6		001		5SY6 132-7		1	1/12 units	001	0.149		
40		5SY6 140-6		001		5SY6 140-7		1	1/12 units	001	0.150		
50		5SY6 150-6		001		5SY6 150-7		1	1/12 units	001	0.168		
63		5SY6 163-6		001		5SY6 163-7		1	1/12 units	001	0.172		
1-Pole + N, 230 V AC 	0.3	2	—				5SY6 514-7		1	1 unit	001	0.328	
	0.5		—				5SY6 505-7		1	1 unit	001	0.325	
	1		—				5SY6 501-7		1	1 unit	001	0.321	
	1.6		—				5SY6 515-7		1	1 unit	001	0.318	
	2		5SY6 506-6		001		5SY6 502-7		1	1 unit	001	0.324	
	3		—				5SY6 503-7		1	1 unit	001	0.314	
	4		5SY6 510-6		001		5SY6 504-7		1	1 unit	001	0.314	
	6		5SY6 513-6		001		5SY6 506-7		1	1/6 units	001	0.310	
	8		—				5SY6 508-7		1	1 unit	001	0.310	
	10		5SY6 510-6		001		5SY6 510-7		1	1/6 units	001	0.301	
	13		5SY6 513-6		001		5SY6 513-7		1	1/6 units	001	0.320	
	15		—				5SY6 218-7		1	1/12 units	001	0.160	
	16		5SY6 516-6		001		5SY6 516-7		1	1/6 units	001	0.302	
	20		5SY6 520-6		001		5SY6 520-7		1	1 unit	001	0.316	
	25		5SY6 525-6		001		5SY6 525-7		1	1 unit	001	0.318	
	32		5SY6 532-6		001		5SY6 532-7		1	1 unit	001	0.319	
	40		5SY6 540-6		001		5SY6 540-7		1	1 unit	001	0.318	
50		5SY6 550-6		001		5SY6 550-7		1	1 unit	001	0.323		
63		5SY6 563-6		001		5SY6 563-7		1	1 unit	001	0.343		
2-Pole, 400 V AC 	0.3	2	—				5SY6 214-7		1	1 unit	001	0.328	
	0.5		—				5SY6 205-7		1	1 unit	001	0.324	
	1		—				5SY6 201-7		1	1/6 units	001	0.302	
	1.6		—				5SY6 215-7		1	1 unit	001	0.317	
	2		—			▶	5SY6 202-7		1	1/6 units	001	0.324	
	3		—				5SY6 203-7		1	1/6 units	001	0.320	
	4		—			▶	5SY6 204-7		1	1/6 units	001	0.300	
	5		—				5SY6 211-7		1	1/12 units	001	0.160	
	6		5SY6 206-6		001	▶	5SY6 206-7		1	1/6 units	001	0.292	
	8		—				5SY6 208-7		1	1 unit	001	0.309	
	10		5SY6 210-6		001	▶	5SY6 210-7		1	1/6 units	001	0.310	
	13		5SY6 213-6		001		5SY6 213-7		1	1 unit	001	0.318	
	15		—				5SY6 218-7		1	1/12 units	001	0.160	
	16		5SY6 216-6		001	▶	5SY6 216-7		1	1/6 units	001	0.291	
	20		5SY6 220-6		001		5SY6 220-7		1	1/6 units	001	0.300	
	25		5SY6 225-6		001		5SY6 225-7		1	1/6 units	001	0.308	
	30		—				5SY6 230-7		1	1/12 units	001	0.160	
	32		5SY6 232-6		001		5SY6 232-7		1	1/6 units	001	0.318	
	40		5SY6 240-6		001		5SY6 240-7		1	1 unit	001	0.318	
50		5SY6 250-6		001		5SY6 250-7		1	1 unit	001	0.330		
63		5SY6 263-6		001		5SY6 263-7		1	1 unit	001	0.340		



¹⁾ 1 MW (modular width) = 18 mm.

* Availability to be announced

5SY6 Supplementary Protection

5SY6 70 mm mounting depth (cont.)

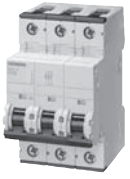
Selection and ordering data

	I_n	Mounting width	DT	Characteristic B			Characteristic C			PU (UNIT, SET, M)	PS*/P. unit	PG	Weight per PU approx. kg
				Order No.	Price per PU	PG DT	Order No.	Price per PU					
MCBs 6000 A 3-Pole, 400 V AC 	0.3	3	▶	—		001 ▶	5SY6 314-7		1	1 unit	001	0.489	
	0.5			—			5SY6 305-7		1	1 unit	001	0.481	
	1			—			5SY6 301-7		1	1 unit	001	0.473	
	1.6			—			5SY6 315-7		1	1 unit	001	0.471	
	2			—			5SY6 302-7		1	1/4 units	001	0.480	
	3			—			5SY6 303-7		1	1 unit	001	0.465	
	4			—			5SY6 304-7		1	1/4 units	001	0.458	
	5			—			5SY6 311-7		1	1/12 units	001	0.160	
	6			5SY6 306-6			001 ▶		5SY6 306-7	1	1/4 units	001	0.435
	8			—			001 ▶		5SY6 308-7	1	1 unit	001	0.461
	10			5SY6 310-6			001 ▶		5SY6 310-7	1	1/4 units	001	0.443
	13			5SY6 313-6			001		5SY6 313-7	1	1 unit	001	0.471
	15			—			001 ▶		5SY6 318-7	1	1/12 units	001	0.160
	16			5SY6 316-6			001 ▶		5SY6 316-7	1	1/4 units	001	0.437
	20			5SY6 320-6			001		5SY6 320-7	1	1/4 units	001	0.455
	25			5SY6 325-6			001		5SY6 325-7	1	1/4 units	001	0.464
	30			—			001 ▶		5SY6 330-7	1	1/12 units	001	0.160
32	5SY6 332-6	001 ▶	5SY6 332-7	1	1/4 units	001	0.459						
40	5SY6 340-6	001	5SY6 340-7	1	1/4 units	001	0.472						
50	5SY6 350-6	001	5SY6 350-7	1	1/4 units	001	0.489						
63	5SY6 363-6	001	5SY6 363-7	1	1/4 units	001	0.488						
3-Pole + N, 400 V AC 	0.3	4		—	001	5SY6 614-7		1	1 unit	001	0.631		
	0.5			—		5SY6 605-7		1	1 unit	001	0.643		
	1			—		5SY6 601-7		1	1 unit	001	0.623		
	1.6			—		5SY6 615-7		1	1 unit	001	0.631		
	2			—		5SY6 602-7		1	1 unit	001	0.632		
	3			—		5SY6 603-7		1	1 unit	001	0.590		
	4			—		5SY6 604-7		1	1 unit	001	0.620		
	6			5SY6 606-6		001		5SY6 606-7	1	1 unit	001	0.609	
	8			—		001		5SY6 608-7	1	1 unit	001	0.607	
	10			5SY6 610-6		001		5SY6 610-7	1	1 unit	001	0.611	
	13			5SY6 613-6		001		5SY6 613-7	1	1/3 units	001	0.630	
	16			5SY6 616-6		001		5SY6 616-7	1	1/3 units	001	0.613	
	20			5SY6 620-6		001		5SY6 620-7	1	1 unit	001	0.623	
	25			5SY6 625-6		001		5SY6 625-7	1	1 unit	001	0.622	
	32			5SY6 632-6		001		5SY6 632-7	1	1 unit	001	0.628	
	40			5SY6 640-6		001		5SY6 640-7	1	1 unit	001	0.629	
	50			5SY6 650-6		001		5SY6 650-7	1	1 unit	001	0.655	
63	5SY6 663-6	001	5SY6 663-7	1	1 unit	001	0.671						
4-Pole, 400 V AC 	0.3	4		—	001	5SY6 414-7		1	1 unit	001	0.640		
	0.5			—		5SY6 405-7		1	1 unit	001	0.641		
	1			—		5SY6 401-7		1	1 unit	001	0.634		
	1.6			—		5SY6 415-7		1	1 unit	001	0.620		
	2			—		5SY6 402-7		1	1 unit	001	0.642		
	3			—		5SY6 403-7		1	1 unit	001	0.625		
	4			—		5SY6 404-7		1	1 unit	001	0.615		
	6			5SY6 406-6		001		5SY6 406-7	1	1 unit	001	0.612	
	8			—		001		5SY6 408-7	1	1 unit	001	0.605	
	10			5SY6 410-6		001		5SY6 410-7	1	1/3 units	001	0.603	
	13			5SY6 413-6		001		5SY6 413-7	1	1 unit	001	0.628	
	16			5SY6 416-6		001		5SY6 416-7	1	1/3 units	001	0.620	
	20			5SY6 420-6		001		5SY6 420-7	1	1/3 units	001	0.598	
	25			5SY6 425-6		001		5SY6 425-7	1	1/3 units	001	0.625	
	32			5SY6 432-6		001		5SY6 432-7	1	1/3 units	001	0.627	
	40			5SY6 440-6		001		5SY6 440-7	1	1/3 units	001	0.628	
	50			5SY6 450-6		001		5SY6 450-7	1	1 unit	001	0.651	
63	5SY6 463-6	001	5SY6 463-7	1	1/3 units	001	0.673						

¹⁾ 1 MW (modular width) = 18 mm.

Supplementary Protection, High-Current Product Range

5SP4 70 mm mounting depth

Features

5SP4 designs have been certified to **UL 1077 and CSA 22.2 No. 235-M 89** and can therefore be used as "supplementary protectors" for applications of up to 277 V AC (1-pole designs) and 480 V AC (2-pole, 3-pole, and 4-pole designs).

Selection and ordering data

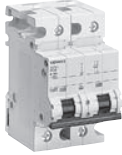
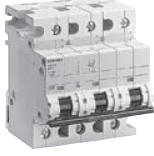
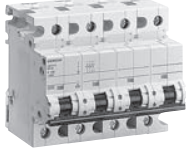
	I_n	MW	Characteristic B		Characteristic C		Characteristic D		Weight 1 item kg
			Order No.	List Price \$	Order No.	List Price \$	Order No.	List Price \$	
1-pole									
	80 100 125	1.5	5SP4 180-6	1 item	5SP4 180-7	1 item	5SP4 180-8	1 item	0.258
			5SP4 191-6		5SP4 191-7		5SP4 191-8		
			5SP4 192-6		5SP4 192-7		-		
2-pole									
	80 100 125	3	5SP4 280-6	1 item	5SP4 280-7	1 item	5SP4 280-8	1 item	0.516
			5SP4 291-6		5SP4 291-7		5SP4 291-8		
			5SP4 292-6		5SP4 292-7		-		
3-pole									
	80 100 125	4.5	5SP4 380-6	1 item	5SP4 380-7	1 item	5SP4 380-8	1 item	0.762
			5SP4 391-6		5SP4 391-7		5SP4 391-8		
			5SP4 392-6		5SP4 392-7		-		
4-pole									
	80 100 125	6	5SP4 480-6	1 item	5SP4 480-7	1 item	5SP4 480-8	1 item	1.032
			5SP4 491-6		5SP4 491-7		5SP4 491-8		
			5SP4 492-6		5SP4 492-7		-		

1 MW = modular width of 18 mm.
Depth = 70 mm.



Supplementary Protection, AC/DC Product Range

5SY5 70 mm mounting depth

Features

All 5SY5 designs have been certified to **UL 1077** and can therefore be used as "supplementary protectors" for applications up to 277 VAC or 250 VDC (1-pole) and 480 VAC or 500 VDC (2-pole).

Selection and ordering data

	I_n	MW ¹⁾	Characteristic B		Characteristic C		Weight 1 item kg
			Order No.	List Price \$ 1 item	Order No.	List Price \$ 1 item	
1-pole							
	0.3	1	-	-	5SY5 114-7	-	0.147
	0.5		-	-	5SY5 105-7	-	
	1		-	-	5SY5 101-7	-	
	1.6		-	-	5SY5 115-7	-	
	2		5SY5 102-6	-	5SY5 102-7	-	
	3		-	-	5SY5 103-7	-	
	4		-	-	5SY5 104-7	-	
	6		5SY5 106-6	-	5SY5 106-7	-	
	8		-	-	5SY5 108-7	-	
	10		5SY5 110-6	-	5SY5 110-7	-	
	13		5SY5 113-6	-	5SY5 113-7	-	
	16		5SY5 116-6	-	5SY5 116-7	-	
	20		5SY5 120-6	-	5SY5 120-7	-	
	25		5SY5 125-6	-	5SY5 125-7	-	
	32 ¹⁾		5SY5 132-6	-	5SY5 132-7	-	
40		5SY5 140-6	-	5SY5 140-7	-		
50		5SY5 150-6	-	5SY5 150-7	-		
63		5SY5 163-6	-	5SY5 163-7	-		
2-pole							
	0.3	2	-	-	5SY5 214-7	-	0.304
	0.5		-	-	5SY5 205-7	-	
	1		-	-	5SY5 201-7	-	
	1.6		-	-	5SY5 215-7	-	
	2		-	-	5SY5 202-7	-	
	3		-	-	5SY5 203-7	-	
	4		-	-	5SY5 204-7	-	
	6		5SY5 206-6	-	5SY5 206-7	-	
	8		-	-	5SY5 208-7	-	
	10		5SY5 210-6	-	5SY5 210-7	-	
	13		5SY5 213-6	-	5SY5 213-7	-	
	16		5SY5 216-6	-	5SY5 216-7	-	
	20		5SY5 220-6	-	5SY5 220-7	-	
	25		5SY5 225-6	-	5SY5 225-7	-	
	32		5SY5 232-6	-	5SY5 232-7	-	
40		5SY5 240-6	-	5SY5 240-7	-		
50		5SY5 250-6	-	5SY5 250-7	-		
63		5SY5 263-6	-	5SY5 263-7	-		

1) MW = modular width of 18 mm.
Depth = 70 mm.

Supplementary Protection

Additional components for 5SY4, 5SY5, 5SY6 and 5SP4 supplementary protectors

Features

- UL Recognized to UL 1077 (5ST3 010, 011, 012, 020, 021 & 022)
- Individual retrofitting possible
- Assembly via factory-fitted clips
- Short-circuit protection via supplementary protectors of characteristic B or C and $I_n = 6 A$ or $6 A gL$ fuses
- Low output versions in accordance with EN 61131-2 for controlling PLCs

Design

Auxiliary switches (AS) and fault signal contacts (FC) (5ST30.0, 5ST30.1, 5ST30.2)

- Min. contact load: 50 mA, 24 V
- Max. contact load:
NO contacts:
2 A, 400 V AC, AC-14
6 A, 230 V AC, AC-14
1 A, 220 V DC, DC-13
1 A, 110 V DC, DC-13
3 A, 60 V DC, DC-13
6 A, 24 V DC, DC-13
NC contacts:
2 A, 400 V AC, AC-13
6 A, 230 V AC, AC-13
1 A, 220 V DC, DC-13
1 A, 110 V DC, DC-13
3 A, 60 V DC, DC-13
6 A, 24 V DC, DC-13

- Connectable to *instabus EIB* and AS-Interface bus via binary inputs

Auxiliary switches (AS) with low output (5ST3013, 5ST3014, 5ST3015)

- Area of application: 1mA / 5 V DC to 50 mA / 30 V DC







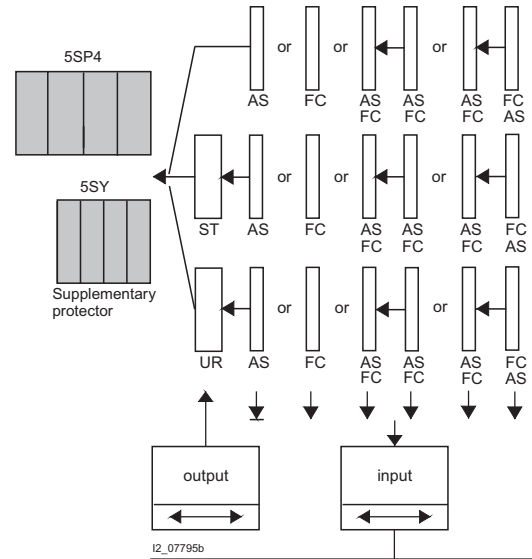

Application

Indication of the supplementary protectors' switching state:

- AS: ON/OFF
- FC: tripped



Selection and ordering data

	MW	Order No.	List Price \$ 1 item	Price group	Weight 1 item kg
	Auxiliary switches (AS) for 5SY4, 5SY5, 5SY6 and 5SP4 supplementary protectors				
		1 NO + 1 NC, 0.5	5ST3 010		0.050
		1 NO + 1 NC, low output ¹⁾	5ST3 013		
		2 NO	5ST3 011		
		2 NO, low output ¹⁾	5ST3 014		
		2 NC	5ST3 012		
	2 NC, low output ¹⁾	5ST3 015			
	Fault signal contacts (FC) for 5SY4, 5SY5, 5SY6 and 5SP4 supplementary protectors				
		1 NO + 1 NC 0.5	5ST3 020		0.050
		2 NO	5ST3 021		
		2 NC	5ST3 022		

¹⁾Not UL Rated.

Supplementary Protection

Additional components for 5SY4, 5SY5, 5SY6 and 5SP4 supplementary protectors

Features

Shunt trips

- Response limits acc. to DIN VDE 0660 Part 100, 7.2.1.4

- Suitable for voltages: 110 to 415 V AC, 110 V AC, 24 to 48 V AC/DC

Application

Remote tripping of the supplementary protectors

Selection and ordering data

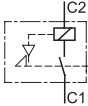
	MW	Order No.	List Price \$	Price group	Weight 1 item
			1 item		kg
	Shunt trips (ST) for 5SY4, 5SY5, 5SY6 and 5SP4 supplementary protectors 1)				
		110-415 V AC	1	5ST3 030	
	24-48 V AC/DC	1	5ST3 031		

Features

Undervoltage releases

- Response limits acc. to DIN VDE 0660 Part 100, 7.2.1.3

- Suitable for voltages: 230 V AC, 110 V DC, 24 V DC
- Connectable to *instabus EIB* and AS-Interface bus via binary inputs.

Application

- Applicable as remote trip in an EMERGENCY-OFF loop
- Assures disconnection of the control circuit acc. to EN 60 204

- In cases of interrupted or insufficient voltage, the undervoltage release trips the supplementary protector or prevents it from switching on.

Selection and ordering data

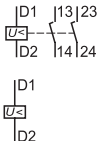
	MW	Order No.	List Price \$	Price group	Weight 1 item
			1 item		kg
	Undervoltage releases (UR) for 5SY4, 5SY5, 5SY6 and 5SP4 supplementary protectors 1)				
		230 V AC	1	5ST3 040	
	110 V DC		5ST3 041		
	24 V DC		5ST3 042		
	230 V AC	1	5ST3 043		
	110 V DC		5ST3 044		
	24 V DC		5ST3 045		

1) Not UL/CSA Rated.

Supplementary Protection Accessories

Accessories for 5SY and 5SP supplementary protectors

Features

- For use with 5SY and 5SP supplementary protectors
- UL and CSA Certified to UL 508

Selection and ordering data



	Length mm	For use with 5SY			For use with 5SP ³⁾		
		Order No.	List Price \$ 1 item	Weight 1 item kg	Order No.	List Price \$ 1 item	Weight 1 item kg
Busbars²⁾ without end caps (can be cut)							
1-pole	1000	5ST3 701-0HG		0.330	5ST3 701-2HG		0.450
1-pole + AS or FC ¹⁾		5ST3 703-0HG			-		
2-pole	1000	5ST3 705-0HG		0.508	5ST3 705-2HG		0.690
2-pole + AS or FC ¹⁾		5ST3 707-0HG			-		
3-pole	1000	5ST3 710-0HG		0.800	5ST3 710-2HG		1.090
3-pole + AS or FC ¹⁾		5ST3 712-0HG			-		
Busbar End Caps							
1-pole		5ST3 748-0HG		0.001	5ST3 748-0HG		0.001
2- & 3- pole		5ST3 750-0HG			5ST3 750-0HG		
Connection terminals							
	Wire size						
Infeed - MCBs	6 - 35 mm ² 10 - 1/0 AWG	5ST3 770-0HG		0.035	5ST3 770-0HG		0.035
Infeed - busbars	1.5 - 50 mm ² 14 - 1 AWG	5ST3 770-1HG		0.016	5ST3 770-1HG		0.016
Touch protection covers²⁾							
	5 x 1 pin	5ST3 655-0HG		0.003	5ST3 655-0HG		0.003

1) Used with appropriate pole supplementary protector + 1 auxiliary switch (AS) or 1 fault signal contact (FC).

2) Always cover all exposed terminals with touch protection covers 5ST3655-0HG.

3) Maximum 100 A for infeed at the start of a busbar.

Technical Data

		5ST3 7...0HG	5ST3 7...2HG	5ST3 770-0HG	5ST3 770-1HG
Standards		UL 508, CSA C22.2 No. 14-M 95,			
Certifications		UL 508 File No. E328403 CSA			
Operational voltage					
• IEC	V AC	690			
• UL 508	V AC	600			
Rated current	A	-	-	115	
Maximum busbar current I_g per phase					
• Infeed at the start of the busbar	A	80	100	-	-
• Infeed at the center of the busbar	A	160	200	-	-
Busbar cross-section	mm ² Cu	18	25	-	-
Conductor cross-sections					
	AWG	-	-	10-1/0	14-1
	mm ²	-	-	6-35	1.5-50
Terminals - terminal tightening torque					
	Nm	-	-	5	3.5
	lbs/in	-	-	50	35

Supplementary Protection Accessories

Accessories for 5SY and 5SP supplementary protectors

Technical Data







Busbar system ¹⁾

- Acc. to DIN 57 606 and DIN 57 659
- Load for one-side/central infeed: 80 A/130 A for 16 mm²

- Pin-type connections
- Single and multi-phase
- Cu: 16 mm² and fully insulated
- Lug spacing: 18 mm

- No additional connection terminal required for stranded connections up to 35 mm²
- Excellent accessibility of the feeder cables
- Busbars do not comply with UL1077

Selection and ordering data

	Length mm	Order No.	List Price \$ 1 item	Price group	Weight 1 item kg
Accessories for 5SY4, 5SY5 miniature circuit-breakers					
	Busbars 16mm²				
	Fully insulated (Do not cut):				
	1-phase	214	5ST3 700		0.040
	1-phase + AS		5ST3 702		
	2-phase		5ST3 704		0.060
	2-phase + AS		5ST3 706		
	3-phase		5ST3 708		0.100
	3-phase + AS		5ST3 711		
	3 × (1-phase + AS)		5ST3 713		
	4-phase		5ST3 715		0.150
Without end caps (Can be cut):					
1-phase	1016	5ST3 701		0.190	
1-phase + AS		5ST3 703			
2-phase		5ST3 705		0.290	
2-phase + AS		5ST3 707			
3-phase		5ST3 710		0.430	
3-phase + AS		5ST3 712			
3 × (1-phase + AS)		5ST3 714			
4-phase		5ST3 716		0.700	
	End caps for lateral insulation of cut-to-length busbars				
	1- phase		5ST3 748		0.001
	2- and 3-phase		5ST3 750		0.001
	4-phase		5ST3 718		0.001
Accessories for 5SY4, 5SY5, 5SP4 supplementary protectors					
   	Handle locking device applicable with all types of poles; sealable against unintended on- and off-switching; padlock with a shackle of max. 3 mm				
			5ST3 801	1 item	0.008
	Terminal cover applicable with all types of poles; as an additional cover for screw openings; prevents removal of the device from the standard mounting rail; sealable				
			5ST3 800		0.001
	Padlock for handle locking device 5ST3 801				
		5ST3 802		0.027	
Locking mechanism consisting of 5ST3 801 handle locking device and 5ST3 802 padlock					
		5ST3 803		0.035	
Inscription labels (white) for 5SY4, 5SY5, 5SP4 miniature circuit-breakers 15 x 9 mm, 3 frames containing 44 labels each, attachable to the lower casing collar • Self-adhesive					
		5ST2 173		0.038	

1) Not UL/CSA Rated.

Technical data

		5SY4	5SY6	5SY5	5SP4
Standards		EN60898 EN 60947-2 UL 1077; CSA C22.2 No. 235	EN60898 EN 60947-2 UL 1077; CSA C22.2 No. 235	EN60898 EN 60947-2	EN60898 EN 60947-2 UL 1077; CSA C22.2 No. 235
Certifications		cE; cURus, UL File No. E116386	cE; cURus, UL File No. E116386	cE; cURus, UL File No. E116386	cE; cURus, UL File No. E106582
Tripping characteristic		A, B, C, D	B, C	B, C	B, C, D
Number of poles		1, 1+N, 2, 3, 3+N, 4	1, 1+N, 2, 3, 3+N, 4	1, 2	1, 2, 3, 4
Operating voltage	Min. V AC/DC	24	24	24	24
	– EN 60898, EN 60947-2	Max. V DC/pole 60 ¹⁾	60 ¹⁾	250	60 ¹⁾
		Max. V AC 400	400	400	400
	– UL 1077 and CSA 22.2 No. 235	Max. V AC 480Y/277 V DC/pole —	480Y/277	480Y/277	480Y/277
Interrupting rating					
I_{cn} to IEC/EN 60898-1	kA AC	10	6	10	10
I_{cn} to IEC/EN 60898-2	kA AC	10	10	10	10
– UL 1077 and CSA 22.2 No. 235	120/240, 240 V: kA AC	14	14	14	14
	240 V: kA AC	7.5	7.5	7.5	7.5
	277 V: kA AC	5	5	5	5
	480 V: kA AC	5	5	5	5
Touch Protection to EN 50274-1		Yes			
Degree of protection to EN 60529		IP20, with connected conductors			
CFC and silicone free		Yes			
Mounting		Yes		—	
– Snap-on mounting		Yes		—	
– Standard mounting rail and mounting		—		Yes	
Device Depth	mm	70			
Terminals		—		Yes	
– Tunnel Terminals at both ends		—		Yes	
– Combined terminals at both ends		Yes		—	
– Terminal, solid, stranded or finely stranded with end sleeve	mm ²	0.75 to 25			
– Terminal tightening torque	lb. in.	22 to 26			
	Nm	2.5 to 3			
Conductor cross sections		—		Yes	
– Solid and stranded	mm ²	0.75 to 35			
– Finely stranded, with end sleeve	mm ²	0.75 to 25			
	AWG	14 to 4			
Calibration Base	°C	30 (EN 60898)			
Average service life, with rated load	Operations	20,000	20,000	20,000 (above 40A: 10, 000)	20,000
Ambient temperature	°C	-25 to 45, occasionally +55, max. 95% humidity			
Storage Temperature	°C	-40 to +75			
Resistance to vibration to IEC 600068-2-6	m/s ²	60 at 10 Hz to 150 Hz			

1) The operating voltage 60 V DC/pole takes into account a battery charging voltage with peak value of 72 V.

Supplementary Protection, General Data

Tripping characteristics and breaking capacity

Tripping characteristics

Tripping performance at an ambient temperature of 30 °C

Tripping characteristic	Standards	Thermal release				Electromagnetic release		
		Test currents:		tripping time		hold	trips at the latest at	tripping time
		low test current	high test current	$63 A \geq I_n$	$63 A \leq I_n$	I_4	I_5	t
A		$1.13 \times I_n$	$1.45 \times I_n$	$> 1 h$ $< 1 h$	$> 2 h$ $< 2 h$	$2 \times I_n$	$3 \times I_n$	$\geq 0.1 s$ $< 0.1 s$
B	IEC 60 898/EN 60 898 DIN VDE 0641 Part 11	$1.13 \times I_n$	$1.45 \times I_n$	$> 1 h$ $< 1 h$	$> 2 h$ $< 2 h$	$3 \times I_n$	$5 \times I_n$	$\geq 0.1 s$ $< 0.1 s$
C		$1.13 \times I_n$	$1.45 \times I_n$	$> 1 h$ $< 1 h$	$> 2 h$ $< 2 h$	$5 \times I_n$	$10 \times I_n$	$\geq 0.1 s$ $< 0.1 s$
D		$1.13 \times I_n$	$1.45 \times I_n$	$> 1 h$ $< 1 h$	$> 2 h$ $< 2 h$	$10 \times I_n$	$20 \times I_n$	$\geq 0.1 s$ $< 0.1 s$

(IEC 60 898: $50 \times I_n$)

Breaking capacity

Breaking capacity ratings for UL1077 are broken down in four main line voltages that are tested. These voltages shown in the table below.

For IEC ratings, there are special requirements with regard to the breaking capacity.

The values are standardized and determined according to the testing conditions of EN 60 898 and DIN VDE 0641 Part 11.

The most usual values are $6\ 000$ and $10\ 000$.

For other test conditions, other values can be specified which lie above those of EN 60 898 and DIN VDE 0641 Part 11.

An example of another standard is EN 60 947-2 or DIN VDE 0660 Part 101 for MCBs.

Interrupting Rating

Rated current	I_n [A]	UL 1077		1-pole 277 V AC	2-, 3-, 4-pole 480 V AC (3-phase)
		1-pole 120/240 V AC (in pairs) 240 V AC	1-pole 240 V AC		
		I_{cn} [kA]	I_{cn} [kA]	I_{cu} [kA]	I_{cu} [kA]
5SP4	80 - 125	14	7.5	5	5
5SY4	0.3 - 63	14	7.5	5	5

Rated current	I_n [A]	UL 1077	
		1-pole 65 V DC	2-pole 125 V DC
		I_{cn} [A]	I_{cn} [A]
5SP4	80 - 125	400	600
5SY4	0.3 - 63	400	600

Rated current	I_n [A]	EN 60 898 (IEC 60 898)		EN 60 947-2 (IEC 60 947-2)	
		1-pole 230 V AC	2-, 3-, 4-pole 400 V AC	1-pole 230 V AC	2-, 3-, 4-pole 400 V AC
		I_{cn} [kA]	I_{cn} [kA]	I_{cu} [kA]	I_{cu} [kA]
5SP4	80 - 125	10	10	15	15
5SY4	0.3 ...6	10	10	35	35
	8 ...32	10	10	20	20
	40 ...63	10	10	15	15

Rated current	I_n [A]	EN 60 898-2		EN 60 898-2	
		1-pole 230 V AC	2-pole 400 V AC	1-pole 220 V DC	2-pole 440 V DC
		I_{cn} [kA]	I_{cn} [kA]	I_{cn} [kA]	I_{cn} [kA]
5SY5	0.5 - 63	10	10	15	15

5SY4, 5SY5, 5SY6 supplementary protectors

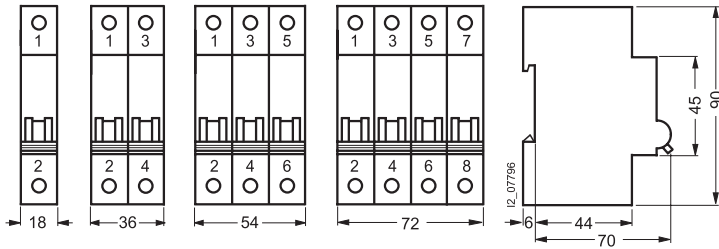

5ST3 auxiliary switch 5ST3 fault signal contact

can be used with 5SY4, 5SY5, 5SY6, 5SP4

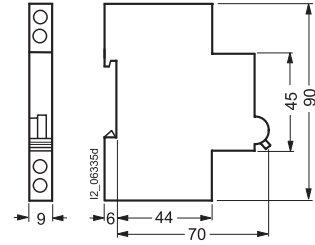

5SP4 supplementary protectors

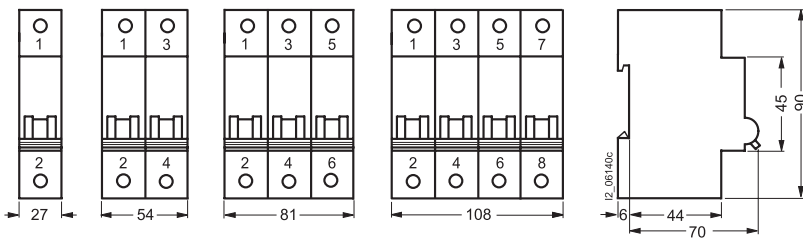

5ST3 shunt trip 5ST3 undervoltage release

can be used with 5SY4, 5SY5, 5SY6, 5SP4

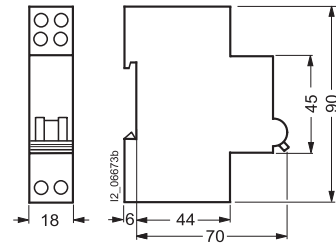

General Data

3NW7 Cylindrical Fuse Holders

Key Common Features

- Meets a wide variety of fuse sizes
- Multi-pole configurations
- Standard 35 mm (DIN) rail mounting
- Housing material meets UL-94-V0, self-extinguishing
- Meets UL 512 and CSA C22.2, No. 39 certifications
- CE Mark
- No tools required for insertion or removal of fuses
- Finger safe design
- With or without Blown Fuse Indicator
- Draw design includes spare fuse holder

Description

Depending on the cylindrical* fuse size selected 3NW7 fuse holders are available in 1, 1 + N, 2, 3, 3 + N and 4 pole configurations. Fuse sizes include 13/32" x 1-1/2" (Class CC and Midget), 8 mm x 32 mm, 10 mm x 38 mm, 14 mm x 51 mm and 22 x 58 mm.

Class CC fuse holders are UL Listed for branch circuit protection according to UL 512 and CSA C22.2, No. 39. They incorporate a rejection feature that only allows Class CC fuses to be used.

Midget, 8 mm x 32 mm, 10 mm x 38 mm, 14 mm x 51 mm, and 22 x 58 mm fuse holders are UL Recognized (refer to Technical Data for specific fuse holder certifications) as supplementary protectors according to UL 512 and CSA C22.2, No. 39. Supplementary protectors are designed to provide additional protection

along with branch circuit protection devices. All fuse holders are equipped with either a fuse handle or draw mechanism for easy insertion and removal of cylindrical type fuses. During insertion and removal the fuses are isolated from the power/control circuit. Their compact size requires less space than typical open-type fuse holders and they mount directly onto standard 35 mm mounting rails.

Fuse holders for 8 mm x 32 mm, 10 mm x 38 mm fuses in the 1 + N draw design occupy the same mounting space as 1 pole designs. This unique design saves space when compared to the typical handle type fuse holder which requires two poles.

3NW7 Cylindrical Fuse Holders

Selection and ordering data

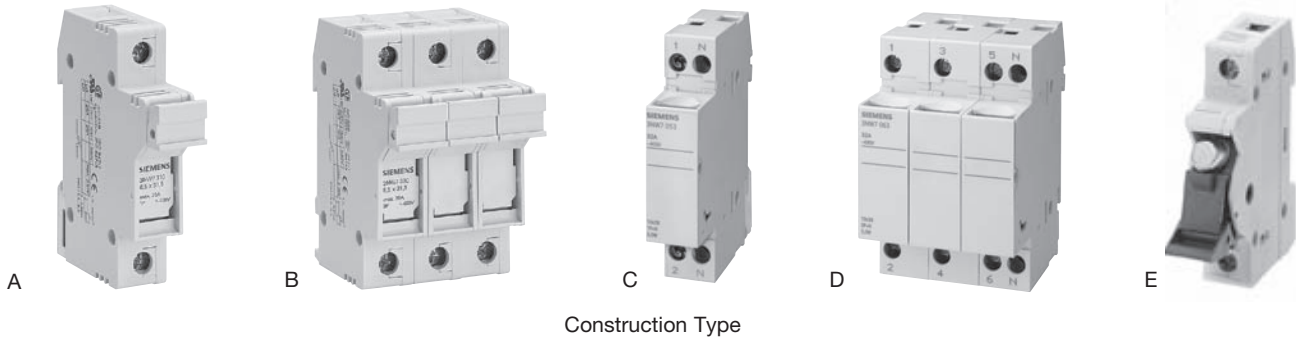

Construction Type

Class CC Fuse Holders: UL Listed for Branch Circuit Protection³⁾

No. of Poles	I _n A	Fuse Size mm x mm	Without Blown Fuse Indicator				With Blown Fuse Indicator ²⁾			
			Order No.	List Price \$ 1 Item	Construction Type	Weight 1 Item kg	Order No.	List Price \$ 1 Item	Construction Type	Weight 1 Item kg
1	30	Class CC 10.3 x 38.1 (13/32" x 1-1/2")	3NW7513-0HG	—	E ¹⁾	0.056	—	—	—	
2			3NW7523-0HG	—		0.118	—	—	—	
3			3NW7533-0HG	—		0.172	—	—	—	

Midget Class Fuse Holders: UL Recognized for Supplementary Protection

No. of Poles	I _n A	Fuse Size mm x mm	Without Blown Fuse Indicator				With Blown Fuse Indicator ²⁾			
			Order No.	List Price \$ 1 Item	Construction Type	Weight 1 Item kg	Order No.	List Price \$ 1 Item	Construction Type	Weight 1 Item kg
1	30	Midget Class 10.3 x 38.1 (13/32" x 1-1/2")	3NW7013	—	C & D ¹⁾	0.056	3NW7014	—	C & D ¹⁾	0.059
1 + N			3NW7053	—		0.069	3NW7054	—		0.072
2			3NW7023	—		0.118	3NW7024	—		0.123
3			3NW7033	—		0.172	3NW7034	—		0.180
3 + N			3NW7063	—		0.185	3NW7064	—		0.193

Other Supplementary Protectors (Refer to page 16/26 for UL and CSA status)

No. of Poles	I _n A	Fuse Size mm x mm	Without Blown Fuse Indicator				With Blown Fuse Indicator ²⁾			
			Order No.	List Price \$ 1 Item	Construction Type	Weight 1 Item kg	Order No.	List Price \$ 1 Item	Construction Type	Weight 1 Item kg
1	20	8 x 32	3NW7313	—	C	0.056	3NW7314	—	C	0.059
	32	10 x 38	3NW7013	—	C	0.056	3NW7014	—	C	0.059
	50	14 x 51	3NW7111	—	A	0.095	3NW7112	—	A	0.095
	100	22 x 58	3NW7211	—	A	0.145	3NW7212	—	A	0.145
1 + N	20	8 x 32	3NW7353	—	C & D ¹⁾	0.069	3NW7354	—	C & D ¹⁾	0.072
	32	10 x 38	3NW7053	—	C & D ¹⁾	0.069	3NW7054	—	C & D ¹⁾	0.072
	50	14 x 51	3NW7151	—	A & B ¹⁾	0.215	3NW7152	—	A & B ¹⁾	0.215
	100	22 x 58	3NW7251	—	A & B ¹⁾	0.330	3NW7252	—	A & B ¹⁾	0.330
2	20	8 x 32	3NW7323	—	C & D ¹⁾	0.118	3NW7324	—	C & D ¹⁾	0.123
	32	10 x 38	3NW7023	—	C & D ¹⁾	0.118	3NW7024	—	C & D ¹⁾	0.123
	50	14 x 51	3NW7121	—	A & B ¹⁾	0.195	3NW7122	—	A & B ¹⁾	0.195
	100	22 x 58	3NW7221	—	A & B ¹⁾	0.300	3NW7222	—	A & B ¹⁾	0.300
3	20	8 x 32	3NW7333	—	C	0.172	3NW7334	—	D	0.180
	32	10 x 38	3NW7033	—	D	0.172	3NW7034	—	D	0.180
	50	14 x 51	3NW7131	—	B	0.295	3NW7132	—	B	0.295
	100	22 x 58	3NW7231	—	B	0.691	3NW7232	—	B	0.480
3 + N	20	8 x 32	3NW7363	—	C & D ¹⁾	0.185	3NW7364	—	C & D ¹⁾	0.193
	32	10 x 38	3NW7063	—	C & D ¹⁾	0.185	3NW7064	—	C & D ¹⁾	0.193
	50	14 x 51	3NW7161	—	A & B ¹⁾	0.315	3NW7162	—	A & B ¹⁾	0.315
	100	22 x 58	3NW7261	—	A & B ¹⁾	0.475	3NW7262	—	A & B ¹⁾	0.475

1) Same Mechanical Design - Other Pole Types Not Shown
2) LED is "ON" when fuse is blown (open)

3) UL 508 busbar available; 5ST3701-0HG, 5ST3705-0HG, 5ST3710-0HG.
See page 16/19.

Technical data

Type		Class CC 3NW75.3-0HG	Midget 3NW70.3, 3NW70.4	3NW73..	3NW70..	3NW71..	3NW72..
Fuse size	mm x mm	10.3 x 38.1	10.3 x 38.1	8 x 32	10 x 38	14 x 51	22 x 58
	inch x inch	13/32" x 1-1/2"	13/32" x 1-1/2"	-	-	-	-
Standards		UL512, CSA C22.2		IEC 60269-1, -2, -3 NF C 60-200, NF C 63-210, -211 NBN C 63269-2-1 CEI 32-4, -12		UL512, CSA C22.2	IEC 60269-1, -2, -3 NF C 60-200, NF C 63-210, -211 NBN C 63269-2-1 CEI 32-4, -12
Certifications		UL Listed, Certified to Canadian Standards	UL Recognized, Certified to Canadian Standards	Not UL / CSA Rated		UL Recognized, Certified to Canadian Standards	Not UL / CSA Rated
UL file no.		E171267		-		E171267	-
Rated voltage	U _n V AC	-	-	400	690		
	UL/CSA V AC	600	600	400	600		
	UL V DC	-	600 ¹⁾	-	-		
Rated current	A	30	30	20	32	50	100
Rated breaking capacity	kA	Fuse Selection Dependent		20	100		
Touch protection to BGV AC		Yes					
Degree of protection to IEC 60529		IP20, with connected conductors					
Operating temperature range	°C	-5 to +40; 90% max. humidity at +20					
Conductor cross sections							
Solid	mm ²	1.5 to 25	0.5 to 10	0.5 to 10		2.5 to 10	4 to 10
Stranded	mm ²	1.5 to 25	0.5 to 10	0.5 to 10		2.5 to 25	4 to 50
Finely Stranded	mm ²	-	0.5 to 10	0.5 to 10		2.5 to 16	4 to 35
UL/CSA	AWG	18 to 4	20 to 10	-	20 to 10	6 to 10	-
Terminal Tightening Torque	Nm	-	-	1.2		2	2.5
	lb. in.	-	-	10.9		18.2	22.7

1) UL Recognized 600 V DC to meet the requirements of the US Solar Industry.

3NW7 Cylindrical fuse holders

Dimensional drawings

Typical Construction Type C & D

3NW73: Fuse Size 8 mm x 32 mm
 3NW70: Fuse Size 10 mm x 38 mm

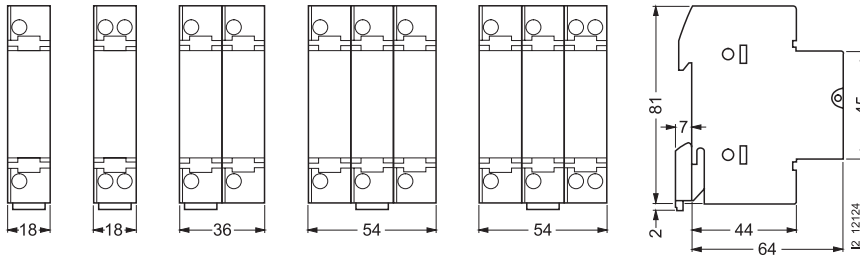

Typical Construction Type E

3NW75.3: Fuse Size 13/32" x 1-1/2", Class CC

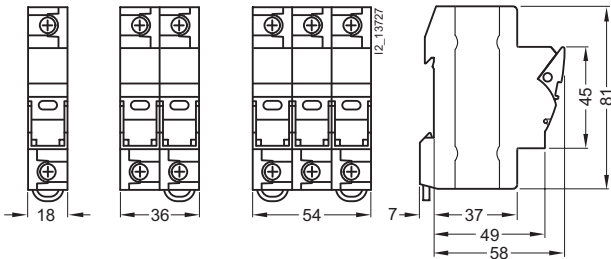

Typical Construction Type A & B

3NW71: 14 mm x 51 mm

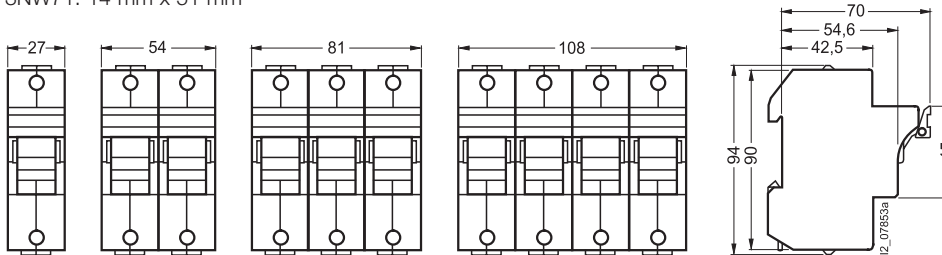

3NW72: 22 mm x 58 mm

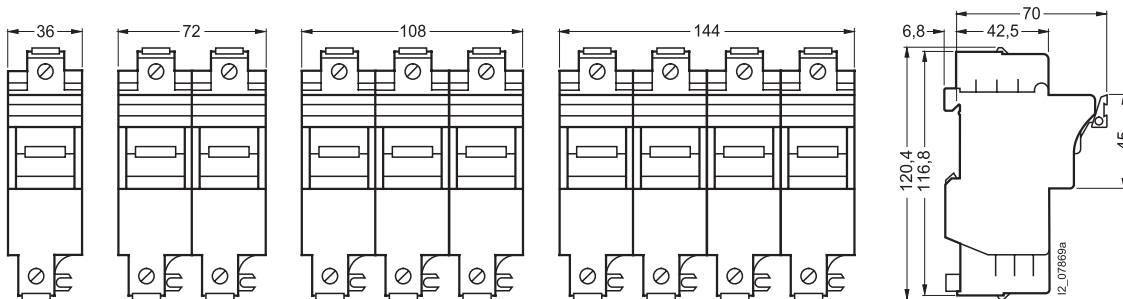

Supplementary Protection