

contents

Thermal overload relays



3RU21 overload relays up to 100 A with screw connection, CLASS 10

Selection and ordering data

- Basic Unit 3/10
- Accessories 3/11

Description	3/8-3/9
Technical data	3/12-3/14
Circuit diagrams	3/15
Dimension drawings	3/16-3/17

Page

Solid state overload relays



3RB24 overload relays up to 630A with IO-Link current monitoring

Selection and ordering data

- Basic Unit 3/51
- Accessories 3/55

Description	3/52-3/53
Technical data	3/58-3/62

Page

SIRIUS 3RV motor starter protectors up to 100 A



3RB20/21, 3RB30/31 overload relays up to 630 A, 3RB20/30 CLASS 10 or 20 3RB21/31 CLASS 5, 10, 20, 30

Selection and ordering data

- Basic Unit 3/22-3/23
- Accessories 3/11

Description	3/18-3/19
Cross Reference Aid	3/21
Technical data	3/24-3/28
Dimension drawings	3/30
Circuit diagrams	3/31

Page



3RB22/23 overload relays up to 820 A for full motor protection, CLASS 5 to CLASS 30 adjustable

Selection and ordering data

- Basic Unit 3/34-3/35
- Accessories 3/49-3/50

Description	3/47
Technical data	3/40-3/43
Dimension drawings	3/45-3/46
Circuit diagrams	3/47

Page



3UF7 SIMOCODE Pro Motor management and control devices

Selection and ordering data

- Basic Unit 3/74-3/76
- Expansion modules 3/77-3/79
- Accessories 3/80-3/82

Description	3/63-3/68
Technical data	3/69-3/73
Software and licenses	3/83-3/86

Page

Overview



Features

3RU21

3RB30/3RB31

3RB20/3RB21

3RB22/3RB23

3RB24

Benefits

General data

Sizes	S00 ... S3	S00 ... S3	S6 ... S12	S00 ... S12	S00 ... S12	<ul style="list-style-type: none"> • Are coordinated with the dimensions, connections and technical characteristics of the other devices in the SIRIUS modular system (contactors, etc., ...) • Permit the mounting of slim and compact load feeders in widths of 45 mm (S00), 45 mm (S0), 55 mm (S2), 70 mm (S3), 120 mm (S6) and 145 mm (S10/S12); this does not include the current measuring modules for the 3RB22 to 3RB24 evaluation modules sizes S00 to S3 • Simplify configuration
Seamless current range	0.11 ... 100 A	0.1 ... 100 A	50 ... 630 A	0.3 ... 630 A (up to 820 A) ¹⁾	0.3 ... 630 A (up to 820 A) ¹⁾	

Protection functions

Tripping due to overload	✓	✓	✓	✓	✓	<ul style="list-style-type: none"> • Provides optimum inverse-time delayed protection of loads against excessive temperature rises due to overload
Tripping due to phase unbalance	✓	✓	✓	✓	✓	
Tripping due to phase failure	✓	✓	✓	✓	✓	<ul style="list-style-type: none"> • Minimizes heating of induction motors during phase failure
Protection of single-phase loads	✓	—	—	✓	✓	<ul style="list-style-type: none"> • Enables the protection of single-phase loads
Tripping in the event of overheating by integrated thermistor motor protection function	— ²⁾	— ²⁾	— ²⁾	✓	✓	<ul style="list-style-type: none"> • Provides optimum temperature-dependent protection of loads against excessive temperature rises e.g. for stator-critical motors or in the event of insufficient coolant flow, contamination of the motor surface or for long starting or braking operations • Eliminates the need for additional special equipment • Saves space in the control cabinet • Reduces wiring outlay and costs
Tripping in the event of a ground fault by internal ground-fault detection (activatable)	—	✓ (only 3RB31)	✓ (only 3RB21)	✓	✓	<ul style="list-style-type: none"> • Provides optimum protection of loads against high-resistance short circuits or ground faults due to moisture, condensed water, damage to the insulation material, etc. • Eliminates the need for additional special equipment • Saves space in the control cabinet • Reduces wiring outlay and costs

✓ Available
— Not available

¹⁾ Motor currents up to 820 A can be recorded and evaluated by a current measuring module, e.g. 3RB29 06-2BG1 (0.3 to 3 A), in combination with 3UF18 68-3GA00 (820 A/1 A) series transformer.

²⁾ The SIRIUS 3RN thermistor motor protection devices can be used to provide additional temperature-dependent protection.



Features	3RU21	3RB30/3RB31	3RB20/3RB21	3RB22/3RB23	3RB24	Benefits
Features						
RESET function	✓	✓	✓	✓	✓	<ul style="list-style-type: none"> Allows manual or automatic resetting of the device
Remote RESET function	✓ (by means of separate module)	✓ (only with 3RB31 and external auxiliary voltage 24 V DC)	✓ (only with 3RB21 and external auxiliary voltage 24 V DC)	✓ (electrically via external button)	✓ (electrically with button or via IO-Link)	<ul style="list-style-type: none"> Allows the remote resetting of the device
TEST function for auxiliary contacts	✓	✓	✓	✓	✓	<ul style="list-style-type: none"> Allows easy checking of the function and wiring
TEST function for electronics	—	✓	✓	✓	✓	<ul style="list-style-type: none"> Allows checking of the electronics
Status display	✓	✓	✓	✓	✓	<ul style="list-style-type: none"> Displays the current operating state
Large current adjustment button	✓	✓	✓	✓	✓	<ul style="list-style-type: none"> Makes it easier to set the relay exactly to the correct current value
Integrated auxiliary contacts (1 NO + 1 NC)	✓	✓	✓	✓ (2 ×)	—	<ul style="list-style-type: none"> Allows the load to be switched off if necessary Can be used to output signals
Integrated auxiliary contacts (1 CO and 1 NO in series)	—	—	—	—	✓	<ul style="list-style-type: none"> Enables the controlling of contactors directly from the higher-level control system through IO-Link
IO-Link connection	—	—	—	—	✓	<ul style="list-style-type: none"> Reduction of wiring in the control cabinet Enables communication
Connection of optional handheld device	—	—	—	—	✓	<ul style="list-style-type: none"> Enables local operation
Communication capability through IO-Link						
Full starter functionality through IO-Link	—	—	—	—	✓	<ul style="list-style-type: none"> Enables in combination with the SIRIUS 3RT contactors the assembly of communication-capable motor starters (direct-on-line, reversing and wye-delta starting)
Reading out of diagnostics functions	—	—	—	—	✓	<ul style="list-style-type: none"> Enables the reading out of diagnostics information such as overload, open circuit, ground fault, etc.
Reading out of current values	—	—	—	—	✓	<ul style="list-style-type: none"> Enables the reading out of current values and their direct processing in the higher-level control system
Reading out all set parameters	—	—	—	—	✓	<ul style="list-style-type: none"> Enables the reading out of all set parameters, e.g. for plant documentation

✓ Available
— Not available



Features

3RU21 **3RB30/3RB31** **3RB20/3RB21** **3RB22/3RB23** **3RB24**

Benefits

Design of load feeders

Short-circuit strength up to 100 kA at 690 V (in conjunction with the corresponding fuses or the corresponding motor starter protector)	✓	✓	✓	✓	✓	<ul style="list-style-type: none"> Provides optimum protection of the loads and operating personnel in the event of short circuits due to insulation faults or faulty switching operations
Electrical and mechanical matching to 3RT contactors	✓	✓	✓	✓ ¹⁾	✓ ¹⁾	<ul style="list-style-type: none"> Simplifies configuration Reduces wiring outlay and costs Enables stand-alone installation as well as space-saving direct mounting
Straight-through transformers for main circuit²⁾ (in this case the cables are routed through the feed-through openings of the overload relay and connected directly to the box terminals of the contactor)	—	✓ (S2, S3)	✓ (S3 to S6)	✓ (S00 ... S6)	✓ (S00 ... S6)	<ul style="list-style-type: none"> Reduces the contact resistance (only one point of contact) Saves wiring costs (easy, no need for tools, and fast) Saves material costs Reduces installation costs
Spring-type connection system for main circuit²⁾	✓ (S00, S0)	✓ (S00, S0)	—	—	—	<ul style="list-style-type: none"> Enables fast connections Permits vibration-resistant connections Enables maintenance-free connections
Spring-type connection system for auxiliary circuits²⁾	✓	✓	✓	✓	✓	<ul style="list-style-type: none"> Enables fast connections Permits vibration-resistant connections Enables maintenance-free connections
Ring terminal lug connection method for main and auxiliary circuits²⁾	✓ (S00, S0)	—	—	—	—	<ul style="list-style-type: none"> Enables fast connections Permits vibration-resistant connections Enables maintenance-free connections
Full starter functionality through IO-Link	—	—	—	—	✓	<ul style="list-style-type: none"> Enables in combination with the SIRIUS 3RT contactors the assembly of communication-capable motor starters (direct-on-line, reversing and wye-delta starting)
Starter function	—	—	—	—	✓	<ul style="list-style-type: none"> Integration of feeders via IO-Link in the control system up to 630 A or 820 A

✓ Available
— Not available

¹⁾ Exception: up to size S3, only stand-alone installation is possible.
²⁾ Alternatively available for screw terminals.

General data



Features	3RU21	3RB30/3RB31	3RB20/3RB21	3RB22/3RB23	3RB24	Benefits
Other features						
Temperature compensation	✓	✓	✓	✓	✓	<ul style="list-style-type: none"> Allows the use of the relays at high temperatures without derating Prevents premature tripping Allows compact installation of the control cabinet without distance between the devices/load feeders
Very high long-term stability	✓	✓	✓	✓	✓	<ul style="list-style-type: none"> Provides safe protection for the loads even after years of use in severe operating conditions
Wide setting ranges	—	✓ (1:4)	✓ (1:4)	✓ (1:10)	✓ (1:10)	<ul style="list-style-type: none"> Minimize the configuration outlay and costs Minimize storage overheads, storage costs, tied-up capital
Fixed trip class	CLASS 10 CLASS 10A	3RB30: CLASS 10E or CLASS 20E	3RB20: CLASS 10 or CLASS 20			<ul style="list-style-type: none"> Optimum motor protection for standard starts
Trip classes adjustable on the device CLASS 5, 10, 20, 30	—	3RB31: ✓	3RB21: ✓	✓	✓	<ul style="list-style-type: none"> Enables solutions for very fast starting motors requiring special protection (e.g. Ex motors) Enables heavy starting solutions Reduces the number of versions
Low power loss	—	✓	✓	✓	✓	<ul style="list-style-type: none"> Reduces energy consumption and energy costs (up 98 % less energy is used than for thermal overload relays). Minimizes temperature rises of the contactor and control cabinet – in some cases this may eliminate the need for control-gear cabinet cooling. Direct mounting to contactor saves space, even for high motor currents (i.e. no heat decoupling is required).
Internal power supply	— ¹⁾	✓	✓	—	—	<ul style="list-style-type: none"> Eliminates the need for configuration and connecting an additional control circuit
Supplied from an external voltage through IO-Link	—	—	—	—	✓	<ul style="list-style-type: none"> Eliminates the need for configuration and connecting an additional control circuit
Overload warning	—	—	—	✓	✓	<ul style="list-style-type: none"> Indicates imminent tripping of the relay directly on the device due to overload, phase unbalance or phase failure through flickering of the LEDs or in the case of the 3RB24 as a signal through IO-Link Allows the imminent tripping of the relay to be signaled Allows measures to be taken in time in the event of inverse-time delayed overloading of the load for an extended period over the current limit
Analog output	—	—	—	✓	✓	<ul style="list-style-type: none"> Allows the output of an analog output signal for actuating moving-coil instruments, feeding programmable logic controllers or transfer to bus systems Eliminates the need for an additional measuring transducer and signal converter

✓ Available
— Not available

¹⁾ SIRIUS 3RU21 thermal overload relays use a bimetal contactor and therefore do not require a control supply voltage.

General data

Overview of overload relays – matching contactors

Overload relays	Current measurement	Current range	Contactors (type, size, rating in HP)							
			3RT20 1.	3RT20 2.	3RT20 3.	3RT20 4.	3RT20 5.	3RT20 6.	3RT20 7	3TF68/ 3TF69
		A	S00	S0	S2	S3	S6	S10	S12	Size 14
Type	Type	A	3/5/7.5/10	5/7.5/10/15/20/25	30/40/50	50/60/70	100/125/150	150/200/250	300/400	500/700

SIRIUS 3RU21 thermal overload relays



3RU21

3RU21 1	Integrated	0.11 ... 16	✓	—	—	—	—	—	—	—
3RU21 2	Integrated	1.8 ... 40	—	✓	—	—	—	—	—	—
3RU21 3	Integrated	22 ... 80	—	—	✓	—	—	—	—	—
3RU21 4	Integrated	28 ... 100	—	—	—	✓	—	—	—	—

SIRIUS 3RB30 solid-state overload relays¹⁾



3RB30

3RB30 1	Integrated	0.1 ... 16	✓	—	—	—	—	—	—	—
3RB30 2	Integrated	0.1 ... 40	—	✓	—	—	—	—	—	—
3RB30 3	Integrated	12 ... 80	—	—	✓	—	—	—	—	—
3RB30 4	Integrated	32 ... 115	—	—	—	✓	—	—	—	—

SIRIUS 3RB31 solid-state overload relays¹⁾



3RB31

3RB31 1	Integrated	0.1 ... 16	✓	—	—	—	—	—	—	—
3RB31 2	Integrated	0.1 ... 40	—	✓	—	—	—	—	—	—
3RB31 3	Integrated	12 ... 80	—	—	✓	—	—	—	—	—
3RB31 4	Integrated	32 ... 115	—	—	—	✓	—	—	—	—

SIRIUS 3RB20 solid-state overload relays¹⁾



3RB20

3RB20 5	Integrated	50 ... 200	—	—	—	—	✓	—	—	—
3RB20 6	Integrated	55 ... 630	—	—	—	—	—	✓	✓	✓
3RB20 1 + 3UF18	Integrated	630 ... 820	—	—	—	—	—	—	—	✓

SIRIUS 3RB21 solid-state overload relays¹⁾



3RB21

3RB21 5	Integrated	50 ... 200	—	—	—	—	✓	—	—	—
3RB21 6	Integrated	55 ... 630	—	—	—	—	—	✓	✓	✓
3RB21 1 + 3UF18	Integrated	630 ... 820	—	—	—	—	—	—	—	✓

✓ Can be used
— Cannot be used

¹⁾ "Technical Specifications" for use of the overload relays with trip class ≥ CLASS 20 can be found in "Short-circuit protection with fuses for motor feeders".

General data

Overview of overload relays – matching contactors (continued)

Overload relays	Current measurement	Current range	Contactors (type, size, rating in HP)							
			3RT20 1	3RT20 2	3RT20 3	3RT20 4	3RT20 5	3RT20 6	3RT20 7	3TF68/ 3TF69
Type	Type	A	S00	S0	S2	S3	S6	S10	S12	Size 14
			3/5/7.5/1.	5/7.5/10/15/ 20/25	30/40/50	50/60/75	100/125/150	150/200/250	300/400	500/700

SIRIUS 3RB22 to 3RB24 solid-state overload relays¹⁾



3RB22, 3RB23



3RB24

Overload relays	Current range	3RT20 1	3RT20 2	3RT20 3	3RT20 4	3RT20 5	3RT20 6	3RT20 7	3TF68/ 3TF69
3RB22 83/ 3RB23 83/ 3RB24 83+	3RB29 0	0.3 ... 25	✓	✓	—	—	—	—	—
	3RB29 0	10 ... 100	✓	✓	✓	✓	—	—	—
	3RB29 5	20 ... 200	—	✓	✓	✓	✓	—	—
	3RB29 6	63 ... 630	—	—	—	—	—	✓	✓
	3RB29 0 + 3UF18	630 ... 820	—	—	—	—	—	—	—

✓ Can be used
— Cannot be used

¹⁾ "Technical Specifications" for use of the overload relays with trip class ≥ CLASS 20 can be found in "Short-circuit protection with fuses for motor feeders",

Connection methods

Depending on the device version of the 3RU2 and 3RB3 overload relays, the terminals for screw terminals, spring-type terminals or ring terminal lug connection are configured for both the main and auxiliary circuit in frame sizes S00 and S0.

The 3RU21 thermal overload relays come with screw terminals.

The electronic overload relays 3RB20 and 3RB21 are available with screw terminals (box terminals) or spring-type terminals on the auxiliary current side; the same applies for the evaluation modules of the 3RB22 to 3RB24 electronic overload relays for High-Feature applications.

Description

The 3RU thermal overload relays up to 100 A are designed for current-dependent protection of applications with normal start-up conditions (see "Trip classes") against impermissibly high rises in temperature as a result of overload or phase failure (see "Phase failure protection"). An overload or phase failure causes the motor current to rise above the set rated motor current (see "Setting"). This current rise heats up the bimetal strips within the relay via heating elements which, in turn, operate the auxiliary contacts via a tripping mechanism due to their deflection (see "Auxiliary contacts"). These switch the load off via a contactor. The switch-off time is dependent on the ratio of tripping current to operational current I_e and is stored in the form of a tripping characteristic with long-term stability (see "Tripping characteristics"). The "Tripped" state is signalled by means of a switching position indicator (see "Indication of status").

Resetting takes place manually or automatically (see "Manual and automatic resetting") after a recovery time has elapsed (see "Recovery time").

The 3RU thermal overload relays are electrically and mechanically optimised to the 3RT contactors such that, in addition to individual mounting, they can also be directly mounted onto the contactors to save space (see "Design and mounting"). The main and auxiliary circuits can be connected in various ways (see "Connection"), including the use of Cage Clamp terminals. When the overload relay has been connected, it can be tested for correct functioning using a TEST slide (see "TEST function"). In addition to the TEST function, the 3RU thermal overload relay is equipped with a STOP function (see "STOP function").

For a wide variety of application possibilities for the 3RU thermal overload relay, please refer to the sections "Application", "Ambient conditions", "Overload relays in WYE-delta combinations" and "Operation with frequency converters".

The 3RU thermal overload relays can protect your loads from overload and phase failure. You must implement short-circuit protection (see "Short-circuit protection") by means of a fuse or circuit-breaker.

The 3RU thermal overload relays are environmentally friendly

(see "Environmental considerations") and comply with all the main international standards and approvals (see "Specifications" and "Increased safety type of protection EEx").

The accessories for the 3RU thermal overload relays have been designed on the principle that all requirements are covered by a small number of variants.

Application

The 3RU thermal overload relays are designed for the protection of three-phase and single-phase AC and DC motors.

If single-phase AC or DC loads are to be protected using 3RU thermal overload relays, all three bimetal strips should be heated. Therefore all main circuits of the relay must be connected in series.

Overload relays in WYE-delta combinations

When overload relays are used in WYE-delta combinations, it is important to note that only $1/\sqrt{3}$ of the motor current flows through the mains contactor. An overload relay mounted on the main contactor must be set to 0.58 times the motor current.

A second overload relay must be mounted on the star contactor if your load is also to be optimally protected in WYE operation. The WYE current is $1/3$ of the rated motor current. The relevant relay must be set to this current.

Control circuit

An additional power supply is not required for operation of the 3RU thermal overload relays.

Ambient conditions

The 3RU thermal overload relays are temperature compensating according to IEC 60 947-4-1/DIN VDE 0660 Part 102 in the temperature range $-20\text{ }^{\circ}\text{C}$ to $+60\text{ }^{\circ}\text{C}$. For temperatures from $+60\text{ }^{\circ}\text{C}$ to $+80\text{ }^{\circ}\text{C}$, the upper setting value of the setting range must be reduced by a specific factor as given in the table below.

Ambient temperature in $^{\circ}\text{C}$	Reduction factor for the upper setting value
+60	1.0
+65	0.94
+70	0.87
+75	0.81
+80	0.73

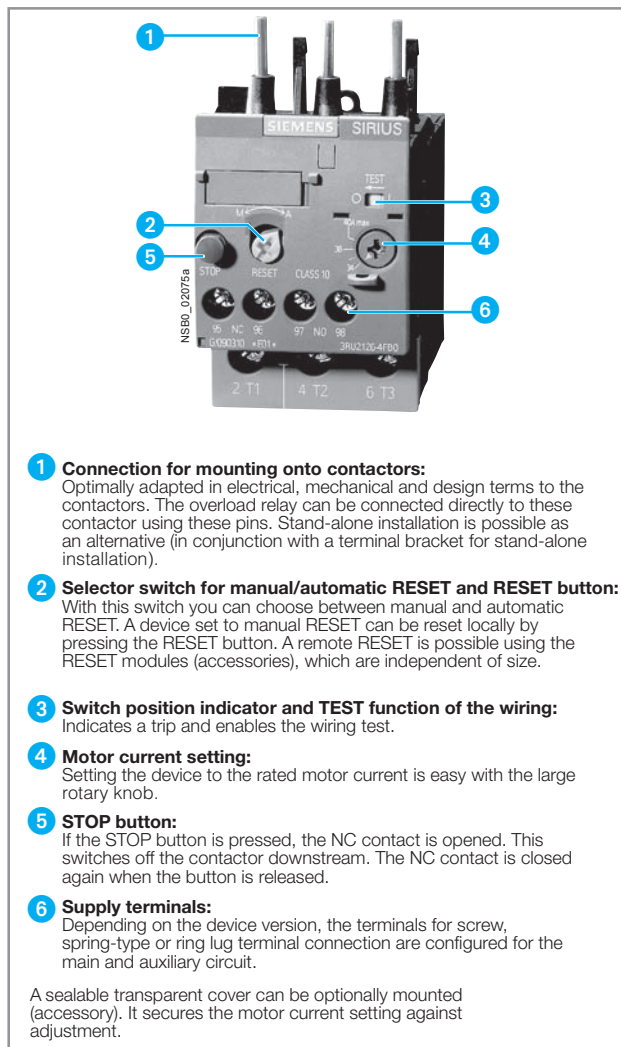

3RU21 26-4FB00 thermal overload relays

- 1 Connection for mounting onto contactors:**
Optimally adapted in electrical, mechanical and design terms to the contactors. The overload relay can be connected directly to these contactor using these pins. Stand-alone installation is possible as an alternative (in conjunction with a terminal bracket for stand-alone installation).
- 2 Selector switch for manual/automatic RESET and RESET button:**
With this switch you can choose between manual and automatic RESET. A device set to manual RESET can be reset locally by pressing the RESET button. A remote RESET is possible using the RESET modules (accessories), which are independent of size.
- 3 Switch position indicator and TEST function of the wiring:**
Indicates a trip and enables the wiring test.
- 4 Motor current setting:**
Setting the device to the rated motor current is easy with the large rotary knob.
- 5 STOP button:**
If the STOP button is pressed, the NC contact is opened. This switches off the contactor downstream. The NC contact is closed again when the button is released.
- 6 Supply terminals:**
Depending on the device version, the terminals for screw, spring-type or ring lug terminal connection are configured for the main and auxiliary circuit.

A sealable transparent cover can be optionally mounted (accessory). It secures the motor current setting against adjustment.

Trip classes

The 3RU thermal overload relay is available for normal start-up conditions in CLASS 10. For further details about trip classes, see "Tripping characteristics".

Tripping characteristics

The tripping characteristics show the relationship between the tripping time and the tripping current as a multiple of the operational current I_e and are specified for symmetrical three-pole and two-pole loading from cold.

The smallest current at which tripping occurs is called the limiting tripping current. In accordance with IEC 60 947-4-1/DIN VDE 0660 Part 102, this must lie within certain specified limits. The limits of the limiting tripping current lie, in the case of the 3RU11 thermal overload re-

lay for symmetrical three-pole loading between 105 % and 120 % of the operational current. Starting from the limiting tripping current, the tripping characteristic moves on to larger tripping currents based on the characteristics of the so-called trip classes (CLASS 10, CLASS 20 etc.). The trip classes describe time-intervals within which the overload relay must trip with 7.2 times the operational current I_e for symmetrical three-pole loading from cold.

The tripping times are:

CLASS	Tripping times
10A	2 s to 10 s
10	4 s to 10 s
20	6 s to 20 s
30	9 s to 30 s

Description

This is the schematic representation of a characteristic. The characteristics of the individual 3RU thermal overload relays can be requested from Technical Assistance at the e-mail address: nst.technical-assistance@siemens.de

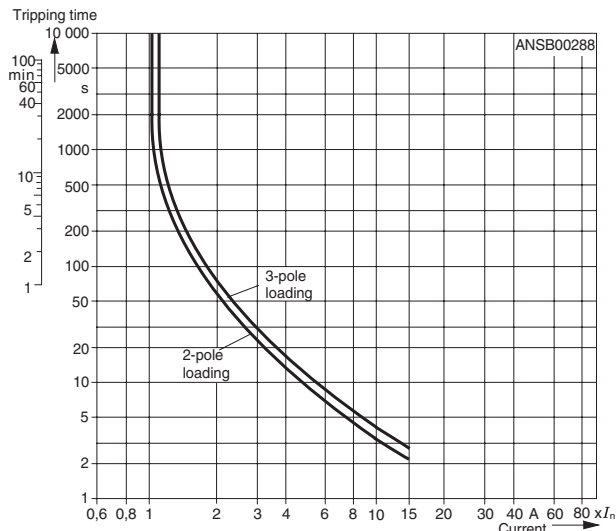

The tripping characteristic of a three-pole 3RU thermal overload relay (see characteristic for symmetrical three-pole loading from cold) is valid when all three bimetal strips are loaded with the same current simultaneously. If, however, only two bimetal strips are heated as a result of phase failure, these two strips would have to provide the force necessary for operating the release mechanism and, if no additional measures were implemented, they would require a longer tripping time or a higher current. These increased current levels over long periods usually result in damage to the consumer. To prevent damage, the 3RU thermal overload relay features phase failure sensitivity which, thanks to an appropriate mechanical mechanism, results in accelerated tripping according to the characteristic for two-pole loading from cold.

In contrast to a load in the cold state, a load at operating temperature has a lower heat reserve. This fact affects the 3RU thermal overload relay in that following an extended period of loading at operational current I_n , the tripping time reduces by about a quarter.

Phase failure protection

The 3RU thermal overload relays feature phase failure protection (see "Tripping characteristics") for the purpose of minimizing the heating of the load during single-phase operation as a result of phase failure.

Setting

The 3RU thermal overload relay is adjusted to the rated motor current using a rotary knob. The scale of the rotary knob is calibrated in Amperes.

Manual and automatic resetting

It is possible to switch between manual resetting and automatic resetting by depressing and rotating the blue button (RESET button). When manual resetting is selected, a reset can be performed directly on the device by pressing the RESET button. Remote resetting can be implemented by using the mechanical and electrical RESET modules from the range of accessories (see "Accessories"). When the blue button is set to Automatic RESET, the relay will be reset automatically.

A reset is not possible until the recovery time has elapsed (see "Recovery time").

Recovery time

After tripping due to an overload, it takes a certain length of time for the bimetal strips of the 3RU thermal overload relays to cool down. The relay can only be reset once it has cooled down. This time (recovery time) is dependent on the tripping characteristic and the level of the tripping current.

After tripping due to overload, the recovery time allows the load to cool down.

TEST function

Correct functioning of the ready 3RU thermal overload relay can be tested with the TEST slide. The slide is operated to simulate tripping of the relay. During this simulation, the NC contact (95-96) is opened and the NO contact (97-98) is closed whereby the overload relay checks that the auxiliary circuit is wired correctly. When the 3RU thermal overload relay is set to Automatic RESET, an automatic reset takes place when the TEST slide is released. The relay must be reset using the RESET button when it is set to Manual RESET.

STOP function

When the STOP button is pressed, the NC contact is opened and the series-connected contactor and therefore the load is switched Off. The load is reconnected via the contactor when the STOP button is released.

Status indication

The current status of the 3RU thermal overload relay is indicated by the position of the marking on the "TEST function/switching position indicator" slide. The marking on the slide is on the left at the "O" mark following a trip due to overload or phase failure and at the "I" mark otherwise.

Auxiliary contacts

The 3RU thermal overload relay is equipped with an NO contact for the tripped signal and an NC contact for switching off the contactor.

Connection

All the 3RU thermal overload relays have screw terminals for the main and auxiliary circuits. Once the box terminals have been removed from the main conductor connections of the overload relays of size S3, it is possible to connect busbars.

Alternatively the devices are available with either spring loaded or with ring lug terminals on both the control and the main terminals. For details of various connection possibilities, see the "Technical data" and "Selection and ordering data".

Design and mounting

The 3RU thermal overload relays are suitable for direct mounting on the 3RT contactors. They can also be mounted as single units if the appropriate adapters are used. For details of the mounting possibilities, see the "Selection and ordering data" and the "Technical data".

Operation with frequency converters

The 3RU thermal overload relays are suitable for operation with frequency converters. Depending on the frequency of the converter, a current higher than the motor current may have to be set due to the occurrence of eddy currents and skin effects.

Environmental considerations

The devices are manufactured taking environmental considerations into account and comprise environmentally-friendly and recyclable materials.

Specifications

The 3RU thermal overload relays comply with the requirements of:

- IEC 60 947-1/ DIN VDE 0660 Part 100
- IEC 60 947-4-1/ DIN VDE 0660 Part 102
- IEC 60 947-5-1/ DIN VDE 0660 Part 200
- IEC 60801-2, -3, -4, -5 and
- UL 508/CSA C 22.2.

The 3RU11 thermal overload relays are also safe from touch according to DIN VDE 0106 Part 100 and climate-proof to IEC 721.

Degree of protection "Increased safety" EEx

The 3RU thermal overload relay meets the requirements for overload protection of motors of the "Increased safety" type of protection EEx e IEC 50 019/ DIN VDE 0165, DIN VDE 0170, DIN VDE 171. KEMA test certificate number Ex-97.Y.3235, DMT 98 ATEX G001, EN 50 019: 1977 + A1 ... A5, Increased Safety "e". Appendix A, Guideline for temperature monitoring of squirrel cage motors during operation.

Accessories

For the 3RU thermal overload relay, there are:

- one adapter for each of the four overload relay sizes S00 to S3 for individual mounting
- one electrical remote RESET module for all sizes in three different voltage variants
- one mechanical remote RESET module for all sizes
- one cable release for all sizes for resetting inaccessible devices
- terminal covers

The accessories can also be used for the 3RB solid state overload relay.

Selection and ordering data

Features and technical characteristics

- Auxiliary contacts: 1 NO + 1 NC
- Manual/automatic RESET
- Switching position indication
- CLASS 10
- TEST function
- STOP button
- Phase failure sensitivity
- Sealable cover: optional in S00, S0 & S2. Integrated in S3

Ordering information

- Replace the (●●) with the letter Number combination from the Terminal types I table
- Replace the (††) with the letter Number combination from the Terminal types II table
- For description, [see page 3/8](#)
- For technical data, [see pages 3/12-3/15](#)
- For circuit diagrams, [see page 3/15](#)
- For dimension drawings, [see page 3/16-3/17](#).

●● Terminal Types I			†† Terminal Types II		
Type	Mounting Type	Ltr	Type	Mounting Type	Ltr
Screw	Direct to Contactor	B0	Screw	Direct to Contactor	B0
Screw ¹⁾	Stand Alone	B1	Screw ⁴⁾	Stand Alone	B1
Spring ²⁾	Direct to Contactor	C0	Spring ³⁾	Direct to Contactor	D0
Spring ^{1) 2)}	Stand Alone	C1	Spring ^{3) 4)}	Stand Alone	D1
Ring Lug	Direct to Contactor	J0			



3RU2116-1GB0



3RU2116-1GC0



3RU2126-4NB0



3RU2136-4RB1



3RU2146-4JB0

Thermal Overload Relays up to 40A
Frame Size S00 and S0 ●●

Setting Range	Order No.	Setting Range	Order No.	Weight approx. (screw/spring) kg
A		A		
Frame Size S00: For mounting directly to 3RT201 contactors or for stand-alone installation				
0.11 - 0.16	3RU2116-0A●●	1.4 - 2	3RU2116-1B●●	0.13/0.15
0.14 - 0.2	3RU2116-0B●●	1.8 - 2.5	3RU2116-1C●●	
0.18 - 0.25	3RU2116-0C●●	2.2 - 3.2	3RU2116-1D●●	
0.22 - 0.32	3RU2116-0D●●	2.8 - 4	3RU2116-1E●●	
0.28 - 0.4	3RU2116-0E●●	3.5 - 5	3RU2116-1F●●	
0.35 - 0.5	3RU2116-0F●●	4.5 - 6.3	3RU2116-1G●●	0.13/0.15
0.45 - 0.63	3RU2116-0G●●	5.5 - 8	3RU2116-1H●●	
0.55 - 0.8	3RU2116-0H●●	7 - 10	3RU2116-1J●●	
0.7 - 1	3RU2116-0J●●	9 - 12.5	3RU2116-1K●●	
0.9 - 1.25	3RU2116-0K●●	11 - 16	3RU2116-4A●●	
1.1 - 1.6	3RU2116-1A●●			0.13/0.15
Frame Size S0: For mounting directly to 3RT202 contactors or for stand-alone installation				
1.8 - 2.5	3RU2126-1C●●	11 - 16	3RU2126-4A●●	0.16/0.22
2.2 - 3.2	3RU2126-1D●●	14 - 20	3RU2126-4B●●	
2.8 - 4	3RU2126-1E●●	17 - 22	3RU2126-4C●●	
3.5 - 5	3RU2126-1F●●	20 - 25	3RU2126-4D●●	
4.5 - 6.3	3RU2126-1G●●	23 - 28	3RU2126-4N●●	
5.5 - 8	3RU2126-1H●●	27 - 32	3RU2126-4E●●	0.16/0.22
7 - 10	3RU2126-1J●●	30 - 36	3RU2126-4P●●	
9 - 12.5	3RU2126-1K●●	34 - 40	3RU2126-4F●●	

Thermal Overload Relays up to 100A
Frame Size S2 and S3 ††

Setting Range	Order No.	Setting Range	Order No.	Weight approx. (screw/spring) kg
A		A		
Frame Size S2: For mounting directly to 3RT203 contactors⁴⁾				
22 - 32	3RU2136-4E††	47 - 57	3RU2136-4Q††	0.34
28 - 40	3RU2136-4F††	54 - 65	3RU2136-4J††	
36 - 45	3RU2136-4G††	62 - 73	3RU2136-4K††	
40 - 50	3RU2136-4H††	70 - 80	3RU2136-4R††	
Frame Size S3: For mounting directly to 3RT204 contactors⁴⁾				
28 - 40	3RU2146-4F††	57 - 75	3RU2146-4K††	
36 - 50	3RU2146-4H††	70 - 90	3RU2146-4L††	
45 - 63	3RU2146-4J††	80 - 100 ⁵⁾	3RU2146-4M††	

- 1) Not available for size S0 3RU212 with current setting range below 14 A.
- 2) Size S00 and S0: main and auxiliary conductor terminals are spring-type.
- 3) Size S2 and S3 auxiliary terminals are spring-type only. Main conductor terminals are screw.
- 4) 3RU Overloads in S2 and S3 frame are available preassembled with a terminal bracket for standalone mounting. S2 and S3 overloads can also be customer assembled to the terminal bracket (see Accessories).
- 5) For overload relays > 100A, see electronic overload relays.

Accessories

	Design	for type	Order No.	Weight approx kg	
		Size			
Terminal brackets for stand-alone installation ¹⁾					
 3RU29 36-3AA01	For separate mounting of the overload relay; panel mount or snapped onto 35 mm standard mounting rail, size S3 also for 75 mm standard mounting rail	<i>Screw terminals</i> S00 S0 S2 S3	3RU29 16-3AA01 3RU29 26-3AA01 3RU29 36-3AA01 3RU29 46-3AA01	0.04 0.05 0.18 0.28	
		<i>Spring Loaded terminals</i> S00 S0	3RU29 16-3AC01 3RU29 26-3AC01	0.04 0.06	
Mechanical RESET					
 with pushbutton, and reset extension 3RU29 00-1A	Resetting plunger, holder, and former overload reset adapter	S00 to S3	3RU29 00-1A	0.038	
	Pushbuttons with extended stroke IP 65 Ø 22 mm, 12 mm hub	S00 to S3	3SU1200-0FB10-0AA0	0.020	
	Extension plungers For compensation of the distance between the pushbutton and the unlatching button of the relay	S00 to S3	3SU1900-0KG10-0AA0	0.004	
	Complete mechanical reset assembly	S00 to S3	3SU1200-0KB10-0AA0 + 3RU1900-1A		
Cable release with holder for RESET					
 3RU29 00-1	For drilled hole Ø 6.5 mm in the control panel max. control panel thickness 8 mm	Length 400 mm Length 600 mm	S00 to S3 S00 to S3	3RU29 00-1B 3RU29 00-1C	0.063 0.073
Module for remote RESET, electrical					
 3RU19 00-2A.71	Operating range 0.85 to 1.1 × U _s Power consumption AC 80 VA, DC 70 W ON period 0.2 s to 4 s AC/DC 24 V to 30 V AC/DC 110 V to 127 V AC/DC 220 V to 250 V	S00 to S3	3RU19 00-2AB71 3RU19 00-2AF71 3RU19 00-2AM71	0.066 0.066 0.066	
Terminal cover					
 3RT1946-4EA1	Cover for cable lug and bar connection	S3	3RT19 46-4EA1	0.040	
	Cover for box terminals	S2 S3	3RT29 36-4EA2 3RT29 46-4EA2	0.020 0.025	
Sealable covers					
 3RV29 08-0P	For covering the rotary setting dials. Order in multiples of 10.	S00 to S2	3RV29 08-0P	0.100	
Tool for opening Spring Loaded terminal connections					
 3RA2908-1A	Suitable up to a For all SIRIUS devices with spring-type terminals		3RA2908-1A	0.045	
	<ul style="list-style-type: none"> Length: approx. 200 mm; 3.0 × 0.5 mm (green) 				

¹⁾ The accessories are identical to those of the 3RB30/3RB31 solid-state overload relays.

Technical data

Type	3RU21 16	3RU21 26	3RU21 36	3RU21 46
Size	S00	S0	S2	S3
Width	45 mm	45 mm	55 mm	70 mm

General data

Release on	overload or phase failure			
Trip class	acc. to IEC 60947-4-1	CLASS 10	10, 10A	10
Phase failure sensitivity	Yes			
Overload warning	No			
Resetting and recovery	Manual, remote and automatic RESET ¹⁾			
Reset possibilities after tripping	on automatic RESET	min	depending on the level of tripping current and the tripping characteristic	
Recovery time	on manual RESET	min	depending on the level of tripping current and the tripping characteristic	
	on remote RESET	min	depending on the level of tripping current and the tripping characteristic	

Features

Indication of status on the device	Yes, using the slide "TEST function/ON-OFF indicator"			
TEST function	Yes			
RESET button	Yes			
STOP button	Yes			

Safe operation of motors with "increased safety" type of protection

EC type test certificate number according to directive 94/9/EC (ATEX)	DMT 98 ATEX G 001 II (2) GD	On request
---	------------------------------	------------

Ambient temperatures

Storage/transport	°C	-55 to +80	-55 to +80
Operation	°C	-40 to +70	-40 to +70
Temperature compensation	°C	up to +60	up to +60
Permissible rated current at	Internal cabinet temperature of 60 °C	%	100 (over +60°C, current reduction is not required)
	Internal cabinet temperature of 70 °C	%	87

Repeat terminals

Repeat coil terminal	Yes	Not required
Auxiliary switch repeat terminal	Yes	Not required

Degree of protection

acc. to IEC 60529	IP 20	IP 20 ²⁾
-------------------	-------	---------------------

Touch protection

acc. to IEC 61140	Finger-safe for vertical contact from the front Finger-safe only with optional terminal covers	
-------------------	---	--

Shock resistance (sine)

acc. to IEC 60068-2-27	g/ms	15/11 (auxiliary contacts 95/96 and 97/98: 8g/11ms)	8/10
------------------------	------	---	------

EMC

• Interference immunity	Not relevant		
• Emitted interference	Not relevant		

Resistance to extreme climates (humidity)

%	90	100
---	----	-----

Dimensions

	see dimensional drawings		
--	--------------------------	--	--

Site altitude

m	Up to 2000; above this on request		
---	-----------------------------------	--	--

Installation angle

The permissible installation angles for mounting onto contactors and individual mounting are shown in the diagrams. For mounting in the shaded area, adjustment compensation of 10 % is necessary.

Individual mounting

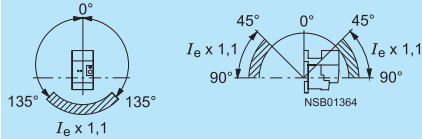

Contactor + overload relay

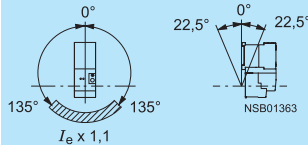

Type of installation/mounting

Mounting onto contactor/stand-alone installation with terminal support (For screw and snap-on mounting onto TH 35 standard mounting rail)	Direct mounting/stand-alone installation with terminal support (For screw and snap-on mounting onto TH34 standard mounting rail size; size S3 also for TH 75 standard mounting rail.*
---	---

1) Remote RESET in combination with the appropriate accessories.
2) Terminal compartment: IP 00 degree of protection.

Technical data					
Type		3RU21 16	3RU21 26	3RU21 36	3RU21 46
Size		S00	S0	S2	S3
Width		45 mm	45 mm	55 mm	70 mm
Main circuit					
Rated insulation voltage U_i (pollution degree 3)	V	690			1000
Rated impulse withstand voltage U_{imp}	kV	6			8
Rated operational voltage U_e	V	690			1000
Type of current	DC AC	Yes Yes, frequency range up to 400 Hz			
Current setting	A	0.11 – 0.16 to 11 – 16	1.8 – 2.5 to 34 – 40	11-16 up to 70-80	18 – 25 to 80 – 100
Power loss per device (max.)	W	4.1...6.3	6.2...7.5	8...14	10 to 16.5
Short-circuit protection	With fuse without contactor With fuse and contactor	See selection and ordering data See technical data (short-circuit protection with fuses / circuit-breaker for motor feeders)			
Protective separation between main and auxiliary current paths	V	440 440	690: Setting ranges ≤ 25 A 440: Setting ranges > 25 A	690 690	690
Acc. to IEC 60947-1, • Screw terminals or ring terminal lug connections • Spring - type terminals					
Connection of the main circuit					
Type of connection		Screw terminals			Screw connection with box terminal ²⁾ / bar connection
Screw terminals					
• Terminal screw		M3, Pozidriv size 2	M4, Pozidriv size 2	M6, Pozidriv size 2	Hexagon socket screw 4 mm
• Operating devices	mm	Ø5 ... 6	Ø5 ... 6	Ø5 ... 6	Ø5 ... 6
• Tightening torque	Nm	0.8 to 1.2	2 to 2.5	3 to 4.5	4 to 6
• Conductor cross-section (min./max.), 1 or 2 wires	Solid or stranded mm ²	2 × (0.5 to 1.5), 2 × (0.75 to 2.5), max. 2 × 4	2 × (1 to 2.5), 2 × (2.5 to 6), max. 2 × (2.5 to 10)	2x(2.5 to 35) 1x(2.5 to 50)	2 × (2.5 to 16)
	Finely stranded with end sleeve mm ²	2 × (0.5 to 1.5), 2 × (0.75 to 2.5)	2 × (1 to 2.5), 2 × (2.5 to 6) max. 1 × 10	2 × (1 to 25) 1 × (1 to 35)	2 × (2.5 to 35), 1 × (2.5 to 50)
	AWG conductor con., solid or stranded AWG	2 × (20 ... 16) 2 × (18 ... 14) 2 × 12	2 × (16 ... 12) 2 × (14 ... 8)	2 × (18 to 2) 1 × (18 to 1)	2 × (10 to 1/0), 1 × (10 to 2/0)
	Ribbon cable (No. × width × thickness) mm	–	–	–	2 × (6 × 9 × 0.8)
Bar connection					
• Terminal screw		–			M 6 × 20
• Tightening torque	Nm	–			4 to 6
• Conductor cross-section (min./max.)	Finely stranded with cable lug mm ²	–			2 × 70
	Stranded with cable lug mm ²	–			2 × 70
	AWG conductor connections, solid or stranded with cable lug AWG	–			2/0
	With connecting bars (max. width) mm	–			12
Auxiliary circuit					
Main contacts: Number of NO contacts		1			
Number of NC contacts		1			
Assignment of auxiliary contacts		1 NO for the signal "tripped"; 1 NC for disconnecting the contactor			
Rated insulation voltage U_i (pollution degree 3)	V	690			
Rated impulse withstand voltage U_{imp}	kV	6			
Switching capacity of auxiliary contacts					
NC for AC AC-14/AC-15	Rated operational current I_e at U_e :	A	4		
	• 24 V	A	4		
	• 120 V	A	4		
	• 125 V	A	4		
	• 230 V	A	3		
	• 400 V	A	2		
	• 600 V	A	0.75		
	• 690 V	A	0.75		

1) For conductor cross-sections for Cage Clamp terminals, see "Connection of the auxiliary circuit."

2) The box terminal can be removed. After the box terminal has been removed, bar connection and lug connection is possible.

Technical data

Type			3RU21 16	3RU21 26	3RU21 36	3RU11 46	
Size			S00	S0	S2	S3	
Width			45 mm	45 mm	55 mm	70 mm	
NO for AC AC-14/AC-15	Rated operational current I_e at U_e :	• 24 V	A	3			3
		• 120 V	A	3			3
		• 125 V	A	3			3
		• 230 V	A	2			2
		• 400 V	A	1			1
		• 600 V	A	0.75			0.6
		• 690 V	A	0.75			0.5
NC, NO for DC DC-13	Rated operational current I_e at U_e :	• 24 V	A	1			1
		• 60 V	A	On request			On request
		• 110 V	A	0.22			0.22
		• 125 V	A	0.22			0.22
		• 220 V	A	0.11			0.11
		Conventional thermal current I_{th}		A	6		
Contact reliability	(suitable for PLC; 17 V, 5 mA)		Yes			Yes	
Short-circuit protection							
With fuse	Utilization cat. gL/gG fast	A	6				
		A	10				
With miniature circuit-breaker (C characteristic)		A	6 ¹⁾				
Reliable operational voltage for protective separation between auxiliary current paths		acc. to IEC 60947-1	V	440			

Connection of the auxiliary circuit

Type of connection			Screw terminal or Cage Clamp terminal	
Connection characteristics			Screw terminals	Cage Clamp terminals
• Terminal screw			Pozidrive Size 2	–
• Tightening torque		Nm	0.8 to 1.2	2 × (0.25 to 2.5)
• Conductor cross-sections (min./max.), 1 or 2 wires	Solid or stranded	mm ²	2 × (0.5 to 1.5), 2 × (0.75 to 2.5)	2 × (0.25 to 2.5)
	Finely stranded without end sleeve	mm ²	–	2 × (0.25 to 2.5)
	Finely stranded with end sleeve	mm ²	2 × (0.5 to 1.5), 2 × (0.75 to 2.5)	2 × (0.25 to 1.5)
	AWG conductor connections, solid or stranded	AWG	2 × (20 to 16) 2 × (18 to 14)	2 × (20 to 14)

1) Up to $I_k \leq 0.5$ kA; ≤ 260 V.

Circuit diagrams

Protection of DC motors

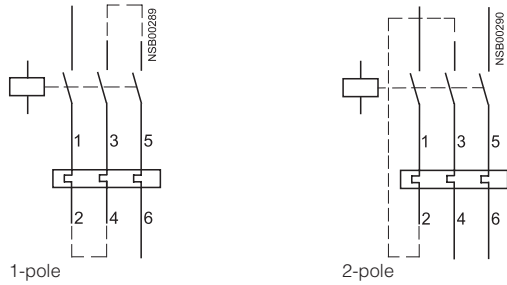

3RU21 16 overload relay

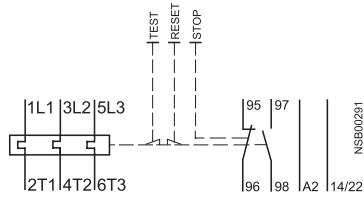

3RU21 26 to 3RU21 46 overload relays

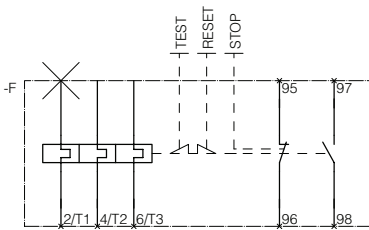

Dimension drawings

Screw connection

Lateral clearance to grounded components: at least 6 mm.

3RU21 16-..B0
Size S00

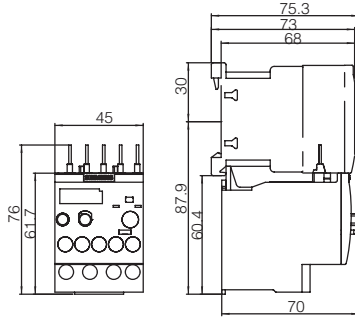

3RU21 16-..B1
Size S00

with adapter for installation as a single unit with accessories

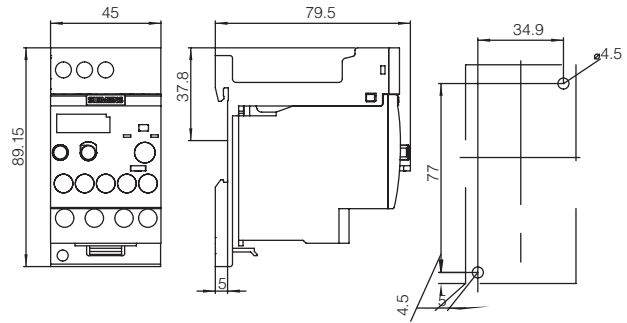

3RU21 26-..B.
Size S0

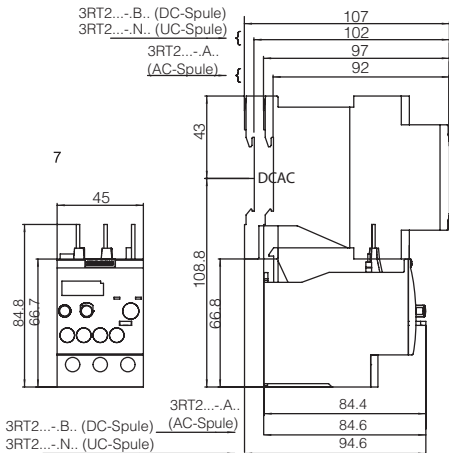

3RU21 26-..B1
Size S0

with adapter for installation as a single unit

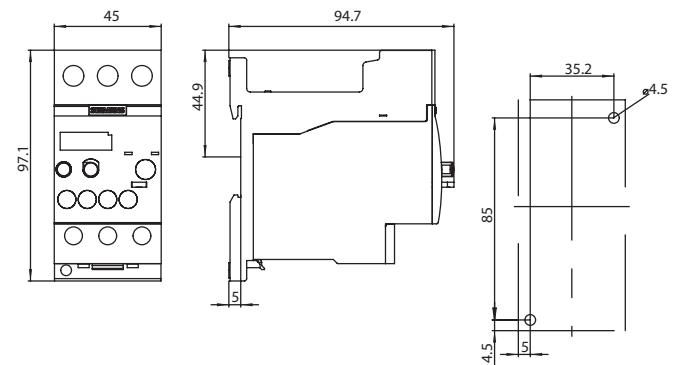

3RU21 36-..B.
Size S2

with adapter for installation as a single unit

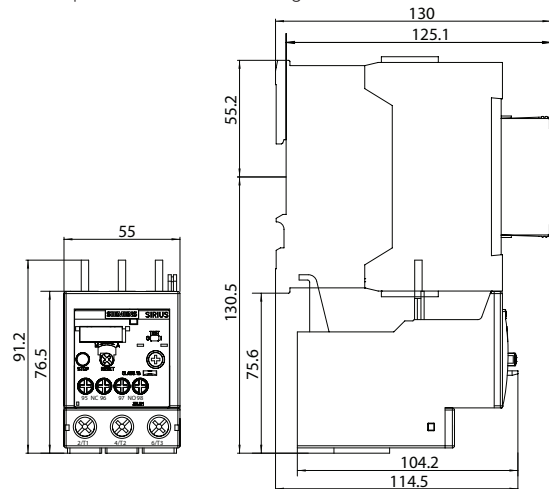

3RU21 46-..B.
Size S3

with adapter for installation as a single unit

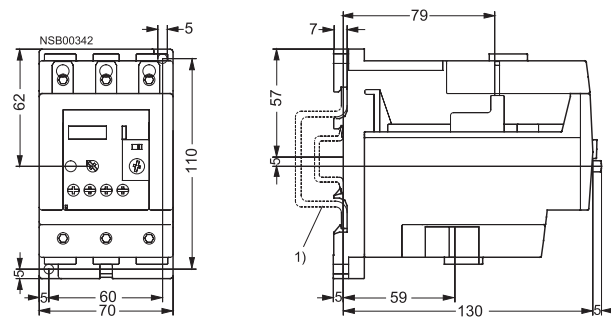

1) For mounting on 35 mm standard mounting rail (15 mm deep) acc. to EN 50 022 or 75 mm standard mounting rail acc. to EN 50023

Dimension drawings "Contactor with built-on overload relay" see contactors and contactor combinations.

Overload Relays

Thermal Overload Relays

3RU21 up to 100 A, CLASS 10

Dimension drawings

Spring Loaded terminals

Lateral clearance to grounded components: at least 6 mm.

3RU21 16 -..C0
Size S00

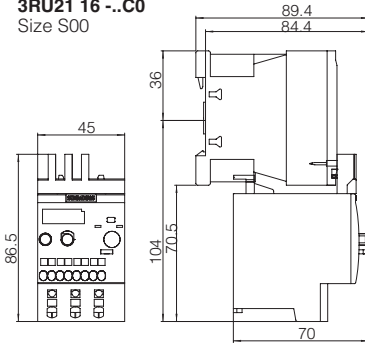

3RU21 16 -..C1

Size S00 with with adapter for installation as a single unit

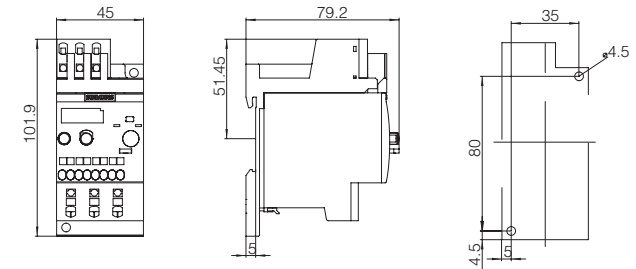

3RU21 26-..C0

Size S0

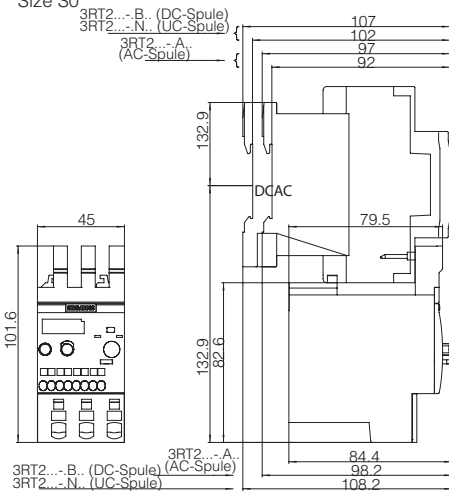

3RU21 26-..C1

Size S0 with adapter for installation as a single unit

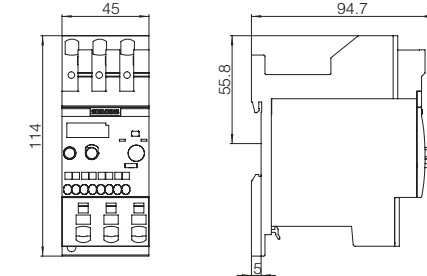

3RU11 46-..D.

Size S3

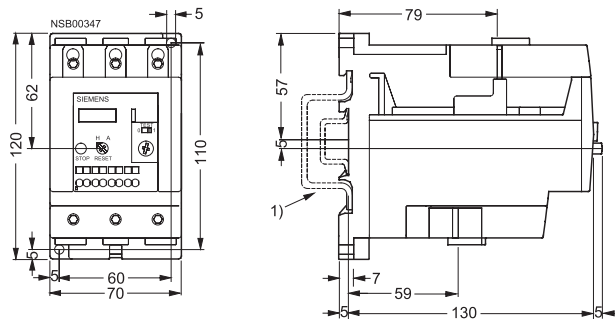

3RU2136-..D.

Size S2

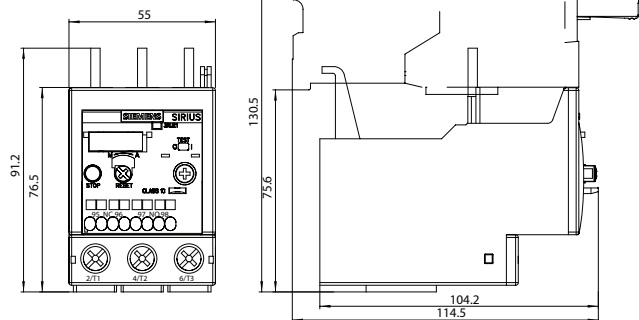

- 1) For mounting on 35 mm standard mounting rail (15 mm deep) acc. to EN 50 022 or 75 mm standard mounting rail acc. to EN 50 023

Dimension drawings "Contactor with built-on overload relay" see contactors and contactor combinations.

Overview

- 1 Connection for mounting onto contactors:**
Optimally adapted in electrical, mechanical and design terms to the contactors. The overload relay can be connected directly to these contactor using these pins. Stand-alone installation is possible as an alternative (in conjunction with a terminal bracket for stand-alone installation).
- 2 Selector switch for manual/automatic RESET and RESET button:**
With this switch you can choose between manual and automatic RESET. A device set to manual RESET can be reset locally by pressing the RESET button. On the 3RB21 a solid-state remote is integrated into the unit.
- 3 Switch position indicator and TEST function of the wiring:**
Indicates a trip and enables the wiring test.
- 4 Solid state test:**
Enables a test of all important device components and functions.
- 5 Motor current setting:**
Setting the device to the rated motor current is easy with the large rotary knob.
- 6 Trip class setting/internal ground-fault detection (3RB21 only):**
Using the rotary switch you can set the required trip class and activate the internal ground-fault detection dependent on the starting conditions.
- 7 Connecting terminals (removable terminal block for auxiliary circuits):**
The generously sized terminals permit connection of two conductors auxiliary circuit can be connected with screw-type terminals or with spring-loaded terminals.

The devices are manufactured in accordance with environmental guidelines and contain environmentally friendly and reusable materials. They comply with important worldwide standards and approvals.

Application

Industries

The 3RB2 / 3RB3 solid-state overload relays are suitable for customers from all industries who want to provide optimum inverse-time delayed protection of their electrical loads (e.g. motors) under normal and heavy starting conditions (CLASS 5 to CLASS 30), minimize project completion times, inventories and power consumption, and optimize plant availability and maintenance management.

Application

The 3RB2 / 3RB3 solid-state overload relays have been designed for the protection of three-phase motors in sinusoidal 50/60 Hz voltage networks. The relays are not suitable for the protection of single-phase AC or DC loads.

The 3RU thermal overload relay or the 3RB22/3RB23 solid-state overload relay can be used for single-phase AC loads. For DC loads the 3RU thermal overload relays are available.

Ambient conditions

The devices are insensitive to external influences such as shocks, corrosive environments, ageing and temperature changes.

For the temperature range from -25 °C to +60 °C, the 3RB2 / 3RB3 solid-state overload relays compensate the temperature according to IEC 60947-4-1.

The 3RB2 / 3RB3 solid-state overload relays are suitable for the overload protection of explosion-proof motors with "increased safety" type of protection EEx e according to ATEX guideline 94/9/EC. The relays meet the requirements of EN 60079-7 (Electrical apparatus for potentially explosive atmospheres – Increased safety "e").

The basic safety and health requirements of ATEX guideline 94/9/EG are fulfilled by compliance with

- EN 60947-1
- EN 60947-4-1
- EN 60947-5-1
- EN 60079-14

EU type test certificate for Group II, Category (2) G/D under application. It has the number PTB 09 ATEX 3001.

Accessories

The following accessories are available for the 3RB2/3RB3 solid-state overload relays:

- One terminal bracket each for the overload relays size S00 and S0 (sizes S2 to S12 can be installed as single units without a terminal bracket)
- One mechanical remote RESET module for all sizes
- One cable release for resetting devices which are difficult to access (for all sizes)
- One sealable cover for all sizes
- Box terminals for sizes S6 and S10/S12
- Terminal covers for sizes S2 to S10/S12

The 3RB and 3RB solid-state overload relays up to 630 A with internal power supply have been designed for inverse-time delayed protection of loads with normal and heavy starting (see Function) against excessive temperature rise due to overload, phase unbalance or phase failure. An overload, phase unbalance or phase failure result in an increase of the motor current beyond the set motor rated current. This current rise is detected by the current transformers integrated into the devices and evaluated by corresponding solid-state circuits which then output a pulse to the auxiliary contacts. The auxiliary contacts then switch off the load by means of the contactors control circuit. The break time depends on the ratio between the tripping current and set current I_e and is stored in the form of a long-term stable tripping characteristic (see Characteristic Curves).

In addition to inverse-time delayed protection of loads against excessive temperature rise due to overload, phase unbalance and phase failure, the 3RB21/31 solid-state overload relays also allow internal ground-fault detection (not possible in conjunction with wye-delta assemblies). This provides protection of loads against high-resistance short-circuits due to damage to the insulation material, moisture, condensed water etc.

The "tripped" status is signaled by means of a switch position indicator (see Function). Resetting takes place either manually or automatically after the recovery time has elapsed (see Function).

Design

Device concept

The 3RB2 / 3RB3 solid-state overload relays are compact devices, i.e. current measurement (transformer) and the evaluation unit are integrated in a single enclosure.

Mounting options

The 3RB2 / 3RB3 solid-state overload relays are suitable for direct and space-saving mounting onto 3RT1 / 3RT2 contactors and 3RW30/3RW31 soft starters as well as for stand-alone installation. For more information on the mounting options, please see [Technical Specifications and Selection and Ordering Data](#)

Connection technique

Main circuit

All sizes of the 3RB2 / 3RB3 solid-state overload relays can be connected with screw-type terminals. As an alternative for sizes S3 to S10/S12, the main circuits can be connected via the Busbar. Sizes S2 to S6 of the 3RB20/3RB21 relays are also available with a straight-through transformer. In this case, the cables of the main circuit are routed directly through the feed-through openings of the relay to the contactor terminals.

Auxiliary circuit

Connection of the auxiliary circuit (removable terminal block) is possible with either screw terminals or spring-loaded terminals.

For more information on the connection options, see [Technical Specifications and Selection and Ordering Data](#).

Overload relays in contactor assemblies for Wye-Delta starting

When overload relays are used in combination with contactor assemblies for Wye-Delta starting it must be noted that only 0.58 times the motor current flows through the line contactor. An overload relay mounted onto the line contactor must be set to 0.58 times the motor current.

When 3RB21 / 31 solid-state overload relays are used in combination with contactor assemblies for Wye-Delta starting, the internal ground-fault detection must not be activated.

Operation with frequency converter

The 3RB2 / 3RB3 solid-state overload relays are suitable for frequencies of 50/60 Hz and the associated harmonics. This permits the 3RB2 / 3RB3 overload relays to be used on the incoming side of the frequency converter.

If motor protection is required on the outgoing side of the frequency converter, the 3RN thermistor motor protection devices or the 3RU thermal overload relays are available for this purpose.

Function

Basic functions

The 3RB2 / 3RB3 solid-state overload relays are designed for:

- Inverse-time delayed protection of loads from overloading
- Inverse-time delayed protection of loads from phase unbalance
- Inverse-time delayed protection of loads from phase failure
- Protection of loads from high-resistance short-circuits (internal ground-fault detection only with 3RB21 / 31).

Control circuit

The 3RB2 / 3RB3 solid-state overload relays have an internal power supply, i.e. no additional supply voltage is required.

Short-circuit protection

Fuses or motor starter protectors must be used for short-circuit protection. For assignments of the corresponding short-circuit protection devices to the 3RB2 / 3RB3 solid-state overload relays with/without contactor see [Technical Specifications and Selection and Ordering Data](#).

Trip classes

The 3RB20 / 30 solid-state overload relays are available for normal starting conditions with trip CLASS 10 or for heavy starting conditions with trip CLASS 20 (fixed setting in each case).

The 3RB21 / 31 solid-state overload relays are suitable for normal and heavy starting. The required trip class (CLASS 5, 10, 20 or 30) can be adjusted by means of a rotary knob depending on the current starting condition.

For details of the trip classes see [Characteristic Curves](#).

Phase failure protection

The 3RB2 / 3RB3 solid-state overload relays are fitted with phase failure protection (see [Characteristic Curves](#)) in order to minimize temperature rise of the load during single-phase operation.

Phase failure protection is not effective for loads with star-connection and a grounded neutral point or a neutral point which is connected to a neutral conductor.

Setting

The 3RB2 / 3RB3 solid-state overload relays are set to the motor rated current by means of a rotary knob. The scale of the rotary knob is shown in amps.

With the 3RB21 / 31 solid-state overload relay it is also possible to select the trip class (CLASS 5, 10, 20 or 30) using a second rotary knob and to switch the internal ground-fault detection on and off.

Manual and automatic reset

In the case of the 3RB2 / 3RB3 solid-state overload relays, a slide switch can be used to choose between automatic and manual resetting.

If manual reset is set, a reset can be carried out directly on the device after a trip by pressing the blue RESET button. Resetting is possible in combination with the mechanical reset options from the accessories range (see [Accessories](#)). As an alternative to the mechanical RESET options, the 3RB21 / 31 solid-state overload relays are equipped with an electrical remote RESET which may be utilized by applying a voltage of 24 V DC to the terminals A3 and A4.

If the slide switch is set to automatic RESET, the relay is reset automatically.

The time between tripping and resetting is determined by the recovery time.

Recovery time

With the 3RB2 / 3RB3 solid-state overload relays the recovery time after inverse-time delayed tripping is between 0.5 and 3 minutes depending on the preloading when automatic RESET is set. These recovery times allow the load (e.g. motor) to cool down.

If the button is set to manual RESET, the 3RB2 / 3RB3 devices can be reset immediately after inverse-time delayed tripping.

After a ground fault trip the 3RB21 / 31 solid-state overload relays (with ground-fault detection activated) can be reset immediately without a recovery time regardless of the reset mode set.

TEST function

With motor current flowing, the TEST button can be used to check whether the relay is working correctly (device/solid-state TEST). Current measurement, motor model and trip unit are tested. If these components are OK, the device is tripped in accordance with the table below. If there is an error, no tripping takes place.

Trip class	Required loading with the rated current prior to pressing the test button	Tripping within
CLASS 5	2 min	8 s
CLASS 10	4 min	15 s
CLASS 20	8 min	30 s
CLASS 30	12 min	45 s

Note: The test button must be kept pressed throughout the test.

Testing of the auxiliary contacts and the control current wiring is possible with the switch position indicator slide. Actuating the slide simulates tripping of the relay. During this simulation the NC contact (95-96) is opened and the NO contact (97-98) is closed. This tests whether the auxiliary circuit has been correctly wired.

After a test trip the relay is reset by pressing the RESET button.

Self-monitoring

The 3RB2 / 3RB3 solid-state overload relays have a self-monitoring feature, i.e. the devices constantly monitor their own basic functions and trip if an internal fault is detected.

Display of operating status

The respective operating status of the 3RB2 / 3RB3 solid-state overload relays is displayed by means of the position of the marking on the switch position indicator slide. After tripping due to overload, phase failure, phase unbalance or ground fault (ground fault detection possible only with 3RB21 / 31) the marking on the slide is to the left on the "O" mark, otherwise it is on the "I" mark.

Auxiliary contacts

The 3RB2 / 3RB3 solid-state overload relays are fitted with an NO contact for the "tripped" signal, and an NC contact for switching off the contactor.

Selection and ordering data

Conversion aid 3RB10 or 3RB20 → 3RB20 or 30

Size	Old Order No.	Setting range A	New Order No.	Setting range A
S00	3RB20 16-□RB0	0.1 ... 0.4	3RB30 16-□RB0	0.1 ... 0.4
	3RB20 16-□NB0	0.32 ... 1.25	3RB30 16-□NB0	0.32 ... 1.25
	3RB20 16-□PB0	1 ... 4	3RB30 16-□PB0	1 ... 4
	3RB20 16-□SB0	3 ... 12	3RB30 16-□SB0	3 ... 12
S0	3RB20 26-□RB0	0.1 ... 0.4	3RB30 26-□RB0	0.1 ... 0.4
	3RB20 26-□NB0	0.32 ... 1.25	3RB30 26-□NB0	0.32 ... 1.25
	3RB20 26-□PB0	1 ... 4	3RB30 26-□PB0	1 ... 4
	3RB20 26-□SB0	3 ... 12	3RB30 26-□SB0	3 ... 12
	3RB20 26-□QB0	6 ... 25	3RB30 26-□QB0	6 ... 25
S2	3RB20 36-□QB0	6 ... 25	3RB30 36-□UB0	12.5 ... 50
	3RB20 36-□UB0	13 ... 50	3RB30 36-□WB0	20 ... 80
S3	3RB10 46-□UB0	13 ... 50	3RB30 46-□UB0	12.5 ... 50
	3RB10 46-□EB0	25 ... 100	3RB30 46-□XB0	32 ... 115
S6	3RB10 56-□FW0	50 ... 200	3RB20 56-□FW2	50 ... 200
	3RB10 56-□FG0		3RB20 56-□FC2	
S10/S12	3RB10 66-□GG0	55 ... 250	3RB20 66-□GC2	55 ... 250
	3RB10 66-□KG0	200 ... 540		
	3RB10 66-□LG0	300 ... 630	3RB20 66-□MC2	160 ... 630

CLASS 10
CLASS 20

1
2

1
2

Conversion aid 3RB10 / 21 → 3RB21 / 31

Size	Old Order No.	Setting range A	New Order No.	Setting range A
S00	3RB21 13-□RB0	0.1 ... 0.4	3RB31 13-4RB0	0.1 ... 0.4
	3RB21 13-□NB0	0.4 ... 1.6	3RB31 13-4NB0	0.32 ... 1.25
	3RB21 13-□PB0	1.5 ... 6	3RB31 13-4PB0	1 ... 4
	3RB21 13-□SB0	3 ... 12	3RB31 13-4SB0	3 ... 12
S0	3RB21 23-□RB0	0.1 ... 0.4	3RB31 23-4RB0	0.1 ... 0.4
	3RB21 23-□NB0	0.32 ... 1.25	3RB31 23-4NB0	0.32 ... 1.25
	3RB21 23-□PB0	1 ... 4	3RB31 23-4PB0	1 ... 4
	3RB21 23-□SB0	3 ... 12	3RB31 23-4SB0	3 ... 12
	3RB21 23-□QB0	6 ... 25	3RB31 23-4QB0	6 ... 25
S2	3RB21 33-□QB0	6 ... 25	3RB31 33-4UB0	12.5 ... 50
	3RB21 33-□UB0	13 ... 50	3RB31 33-4WB0	20 ... 80
S3	3RB10 46-□UB0	12.5 ... 50	3RB31 43-4UB0	12.5 ... 50
	3RB10 46-□EB0	25 ... 100	3RB31 43-4XB0	32 ... 115
S6	3RB10 56-□FW0	50 ... 200	3RB21 53-4FW2	50 ... 200
	3RB10 56-□FG0		3RB21 53-4FC2	
S10/S12	3RB10 66-□GG0	55 ... 250	3RB21 63-4GC2	55 ... 250
	3RB10 66-□KG0	200 ... 540		
	3RB10 66-□LG0	300 ... 630	3RB21 63-4MC2	160 ... 630

CLASS 10
CLASS 20

1
2

Note:







CLASS 5, 10, 20 and 30 can be set on the unit

3RB20 solid-state overload relays and stand-alone installation²⁾³⁾, CLASS 10 or CLASS 20 for direct mounting¹⁾²⁾

Features and technical specifications:

- Overload protection, phase failure protection and unbalance protection
- Internal power supply
- Auxiliary contacts 1 NO + 1 NC
- Manual and automatic RESET
- Switch position indicator
- TEST function and self-monitoring

OVERLOAD RELAYS 3

Size Contactor ⁴⁾	Set current value of the inverse-time delayed overload trip	Screw Terminal Order Number	Spring Loaded Terminal Order Number	Weight per PU approx. kg		
Size S00¹⁾						
 3RB30 16-1RB0	S00	0.1 ... 0.4	3RB30 16-□RB0	3RB30 16-□RE0	0.172	
		0.32 ... 1.25	3RB30 16-□NB0	3RB30 16-□NE0	0.172	
		1 ... 4	3RB30 16-□PB0	3RB30 16-□PE0	0.172	
		3 ... 12	3RB30 16-□SB0	3RB30 16-□SE0	0.172	
		4 ... 16	3RB30 16-□TB0	3RB30 16-□TE0	0.172	
Size S0¹⁾						
 3RB30 26-1QB0	S0	0.1 ... 0.4	3RB30 26-□RB0	3RB30 26-□RE0	0.250	
		0.32 ... 1.25	3RB30 26-□NB0	3RB30 26-□NE0	0.250	
		1 ... 4	3RB30 26-□PB0	3RB30 26-□PE0	0.250	
		3 ... 12	3RB30 26-□SB0	3RB30 26-□SE0	0.250	
		6 ... 25	3RB30 26-□QB0	3RB30 26-□QE0	0.250	
	10 ... 40	3RB30 26-□VB0	3RB30 26-□VE0	0.250		
Size S2¹⁾³⁾⁵⁾						
 3RB30 36-1UB0	S2	12 ... 50	with busbar with pass through CT's	3RB30 36-□UB0	3RB30 36-□UD0	0.360
				3RB30 36-□UW1	3RB30 36-□UX1	0.230
	20 ... 80	with busbar with pass through CT's	3RB30 36-□WB0	3RB30 36-□WD0	0.360	
			3RB30 36-□WW1	3RB30 36-□WX1	0.230	
Size S3¹⁾³⁾⁵⁾						
 3RB30 46-1XB0	S3	12.5 ... 50	with busbar with pass through CT's	3RB30 46-□UB0	3RB30 46-□UD0	0.560
				3RB30 46-□UW1	3RB30 46-□UX1	0.450
	32 ... 115	with busbar with pass through CT's	3RB30 46-□XB0	3RB30 46-□XD0	0.560	
			3RB30 46-□XW1	3RB30 46-□XX1	0.450	
Size S6²⁾⁵⁾						
 3RB20 56-1FW2	S6	50 ... 200	with busbar	3RB20 56-□FC2	3RB20 56-□FF2	1.030
			with pass through CT's	3RB20 56-□FW2	3RB20 56-□FX2	0.690
Size S10/S12²⁾						
 3RB20 66-1MC2	S10/S12 and size 14 (3TF68/3TF69)	55 ... 250	with busbar	3RB20 66-□GC2	3RB20 66-□GF2	1.820
		160 ... 630	with busbar	3RB20 66-□MC2	3RB20 66-□MF2	1.820

2 Class 20
1 Class 10

2 Class 20
1 Class 10

1) The relays with an Order No. ending with "0" are designed for direct mounting to the contactor. With the matching terminal brackets (see Accessories) the sizes S00 to S3 can also be installed as stand-alone units.
 2) The relays with an Order No. ending with "2" are designed for direct mounting and stand-alone installation. For 3TF68/3TF69 contactors, direct mounting is not possible.
 3) The relays with an Order No. ending with "1" are designed for stand-alone installation.
 4) Observe maximum rated operational current of the devices.
 5) The relays with an Order No. with "X" in 10th position are equipped with a straight-through transformer.

For accessories, see pages 3/49-3/50.
 For description, see pages 3/18-3/20.
 For technical data, see pages 3/24-3/29.
 For dimension drawings, see page 3/30.
 For schematic diagrams, see page 3/31.





3RB2 / 3RB3 Solid-State Overload Relays

3RB20, 3RB21, 3RB30, 3RB31 up to 630A for standard applications

3RB21 / 3RB31 solid-state overload relays for direct mounting¹⁾²⁾ and stand-alone installation²⁾³⁾, CLASS 5, 10, 20 and 30 adjustable

Features and technical specifications:

- Overload protection, phase failure protection and unbalance protection
- Internal ground fault detection (activatable)
- Internal power supply
- Auxiliary contacts 1 NO + 1 NC
- Manual and automatic RESET
- Electrical remote RESET integrated
- Switch position indicator
- TEST function and self-monitoring

Size	Size Contactor ⁴⁾	Set current value of the inverse-time delayed overload trip	Screw Terminal Order Number	Spring Loaded Terminal Order Number	Weight per PU approx.
					kg
Size S00¹⁾					
	S00	0.1 ... 0.4	3RB31 13-4RB0	3RB31 13-4RE0	0.175
		0.32 ... 1.25	3RB31 13-4NB0	3RB31 13-4NE0	0.175
		1 ... 4	3RB31 13-4PB0	3RB31 13-4PE0	0.175
		3 ... 12	3RB31 13-4SB0	3RB31 13-4SE0	0.175
		4 ... 16	3RB31 13-4TB0	3RB31 13-4TE0	0.175
Size S0¹⁾					
	S0	0.1 ... 0.4	3RB31 23-4RB0	3RB31 23-4RE0	0.215
		0.32 ... 1.25	3RB31 23-4NB0	3RB31 23-4NE0	0.215
		1 ... 4	3RB31 23-4PB0	3RB31 23-4PE0	0.215
		3 ... 12	3RB31 23-4SB0	3RB31 23-4SE0	0.215
		6 ... 25	3RB31 23-4QB0	3RB31 23-4QE0	0.215
10 ... 40	3RB31 23-4VB0	3RB31 23-4VE0	0.215		
Size S2¹⁾³⁾⁵⁾					
	S2	12 ... 50	with busbar with pass through CT's	3RB31 33-4UB0 3RB31 33-4UW1	0.360 0.230
		20 ... 80	with busbar with pass through CT's	3RB31 33-4WB0 3RB31 33-4WW1	0.360 0.230
Size S3¹⁾³⁾⁵⁾					
	S3	12.5 ... 50	with busbar with pass through CT's	3RB31 43-4UB0 3RB31 43-4UW1	0.560 0.450
		32 ... 115	with busbar with pass through CT's	3RB31 43-4XB0 3RB31 43-4XW1	0.560 0.450
Size S6²⁾⁵⁾					
	S6	50 ... 200	with busbar	3RB21 53-4FC2	1.030
			with pass through CT's	3RB21 53-4FW2	0.690
Size S10/S12²⁾					
	S10/S12 and size 14 (3TF68/3TF69)	55 ... 250		3RB21 63-4GC2	1.820
		160 ... 630		3RB21 63-4MC2	1.820

- 1) The relays with an Order No. ending with "0" are designed for direct mounting to the contactor. With the matching terminal brackets (see Accessories) the sizes S00 to S3 can also be installed as stand-alone units.
- 2) The relays with an Order No. ending with "2" are designed for direct mounting and stand-alone installation. For 3TF68/3TF69 contactors, direct mounting is not possible.
- 3) The relays with an Order No. ending with "1" are designed for stand-alone installation.
- 4) Observe maximum rated operational current of the devices.
- 5) The relays with an Order No. with "X" in 10th position are equipped with a straight-through transformer.

For accessories, see pages 3/49-3/50.
 For description, see pages 3/18-3/21.
 For technical data, see pages 3/24-3/29.
 For dimension drawings, see page 3/30.
 For schematic diagrams, see page 3/31.

Technical specifications

Type	3RB30 16, 3RB31 13	3RB30 26, 3RB31 23	3RB30 36 3RB31 33	3RB30 46, 3RB31 43	3RB30 56, 3RB31 53	3RB30 66, 3RB31 63
Size	S00	S0	S2	S3	S6	S10/S12
Width	45 mm	45 mm	55 mm	70 mm	120 mm	145 mm
General data						
Trips in the event of	Overload, phase failure, and phase unbalance + ground fault (for 3RB31 only)					
Trip class according to IEC 60947-4-1	CLASS 3RB30: 10E, 20E; 3RB31: 5E, 10E, 20E or 30E adjustable					
Phase failure sensitivity	Yes					
Overload warning					No	
Reset and recovery	Manual and automatic RESET, 3RB31 has an integrated connection for electrical remote RESET (24 V DC)			3RB20: Manual and automatic RESET; 3RB21: Manual, automatic and remote RESET		
• Reset options after tripping						
• Recovery time						
- For automatic RESET	min.	Approx. 3 min		Approx. 3 min		
- For manual RESET	min.	Immediately		Immediately		
- For remote RESET	min.	Immediately		Immediately		
Features	<ul style="list-style-type: none"> • Display of operating status on device • TEST function 					
• RESET button	Yes					
• STOP button	No					
Explosion protection – Safe operation of motors with "Increased safety" type of protection EC type test certificate number according to directive 94/9/EC (ATEX)	PTB 09 ATEX 3001 ⊗ II (2) G [Ex e] [Ex d] [Ex px] ⊗ II (2) G [Ex t] [Ex p]		On request	PTB 09 ATEX 3001 ⊗ II (2) G [Ex e] [Ex d] [Ex px] ⊗ II (2) G [Ex t] [Ex p]		
Ambient temperatures	<ul style="list-style-type: none"> • Storage/transport °C -40 ... +80 • Operation °C -25 ... +60 • Temperature compensation °C +60 • Permissible rated current at <ul style="list-style-type: none"> - Temperature inside control cabinet 60 °C, stand-alone installation % — - Temperature inside control cabinet 60 °C, mounted on contactor % 100 - Temperature inside control cabinet 70 °C % On request 					
Repeat terminals	Yes		Not required			
• Coil repeat terminal	Yes		Not required			
• Auxiliary contact repeat terminal	Yes		Not required			
Degree of protection according to IEC 60529	IP20 ³⁾			IP20 ³⁾		
Touch protection according to IEC 61140	Finger-safe for vertical contact from the front			Finger-safe, for busbar connection with cover		Finger-safe with cover
Shock resistance with sine according to IEC 60068-2-27 9/ms	15/11 (signaling contact 97/98 in position "tripped": 9g/ms)		15/11 (signaling contact 97/98 in "tripped" position: 8 g/11ms)	15/11 (signaling contact 97/98 in position "tripped": 4 g/11ms)		
Electromagnetic compatibility (EMC) – Interference immunity	<ul style="list-style-type: none"> • Conductor-related interference <ul style="list-style-type: none"> - Burst according to IEC 61000-4-4 (corresponds to degree of severity 3) kV 2 (power ports), 1 (signal ports) - Surge according to IEC 61000-4-5 (corresponds to degree of severity 3) kV 2 (line to earth), 1 (line to line) • Electrostatic discharge according to IEC 61000-4-2 (corresponds to degree of severity 3) kV 8 (air discharge), 6 (contact discharge) • Field-related interference according to IEC 61000-4-3 (corresponds to degree of severity 3) V/m 10 					
Electromagnetic compatibility (EMC) – Emitted interference	Degree of severity B according to EN 55011 (CISPR 11) and EN 55022 (CISPR 22)					
Resistance to extreme climates – air humidity	% 95			% 100		
Dimensions	See dimensional drawings					
Installation altitude above sea level	m Up to 2000					
Mounting position	Any					
Type of mounting	Direct mounting/stand-alone installation with terminal support				Direct mounting / Stand-alone installation	

1) Permissible rated current in case of heavy starting
Size S0 at 10 A up to 40 A
- CLASS 20, I_e max = 32 A
- CLASS 30, I_e max = 25 A

2) 90 % for relay with current setting range 160A to 630A
3) Terminal compartment: degree of protection IP00.

Type		3RB30 16, 3RB31 13 S00 45 mm	3RB30 26, 3RB31 23 S0 45 mm	3RB30 36, 3RB31 33 S2 55 mm	3RB30 46, 3RB31 43 S3 70 mm
Main circuit					
Rated insulation voltage U_i (pollution degree 3)	V	690	690	690	1000
Rated impulse withstand voltage U_{imp}	kV	6	6	6/8	8
Rated operational voltage U_e	V	690	690	690	1000
Type of current • Direct current • Alternating current		No Yes, 50/60 Hz \pm 5%			
Set current	A	0.1 ... 0.4 to 4 ... 16	0.1 ... 0.4 to 10 ... 40	12.5 ... 50 and 20 to 80	12.5 ... 50 to 25 ... 100
Power loss per unit (max.)	W	0.05 ... 0.2			0.05
Short-circuit protection - With fuse without contactor - With fuse and contactor		See Selection and Ordering Data See Technical Specifications (short-circuit protection with fuses for motor feeders)			
Protective separation between main and auxiliary conducting path according to IEC 60947-1 (pollution degree 2)	V	690 for grounded networks, otherwise 600 V			
Connection for main circuit					
Electrical connection version		Screw terminal	Screw terminal	Screw terminal	Screw terminal with box terminal /
Screw terminal • Terminal screw • Tightening torque • Conductor cross-sections (min./max.) - Solid or stranded					
	Nm	M3, Pozidriv size 2 0.8 ... 1.2	M3, Pozidriv size 2 2 ... 2.5	M4, Pozidriv size 2 2 ... 2.5	M8, 4 mm Allen screw 4 ... 6
	mm ²	2 × (0.5 ... 1.5) ³⁾ 2 × (0.75 ... 2.5) ³⁾ 2 × (0.05 ... 4) ³⁾	2 × (1 ... 2.5) ³⁾ 2 × (2.5 ... 10)	1 × (1 ... 50) 2 × (1 ... 35) (Solid or Stranded)	2 × (2.5 ... 16)
- Finely stranded with end sleeve (DIN 46228 T1)	mm ²	2 × (0.5 ... 1.5) ³⁾ 2 × (0.75 ... 2.5) ³⁾	2 × (1 ... 2.5) ³⁾ 2 × (2.5 ... 6) ³⁾ max. 1 × 10	2 × (1 ... 25), 1 × (1 ... 35)	2 × (2.5 ... 35), 1 × (2.5 ... 50)
- Stranded	mm ²	--	--	--	2 × (10 ... 50), 1 × (10 ... 70)
- AWG cables, solid or stranded	AWG	2 × (20 ... 16) ³⁾ 2 × (18 ... 14) ³⁾ 2 × 12	2 × (16 ... 12) ³⁾ 2 × (14 ... 8) ³⁾	2 × (18 ... 2) 1 × (18 ... 1)	2 × (10 ... 1/0), 2 × (10 ... 2/0)
- Ribbon cable conductors (number x width x circumference)	mm	--	--	--	2 × (6 × 9 × 0.8)
Busbar connections • Terminal screw • Tightening torque • Conductor cross-section (min./max.) - Finely stranded with cable lug - Stranded with cable lug - AWG connections, solid or stranded, with cable lug - With connecting bar (max. width)					
	Nm	--	--	--	M 6 × 20 4 ... 6
	mm ²	--	--	--	2 × 70
	mm ²	--	--	--	3 × 70
	AWG	--	--	--	2/0
	mm	--	--	--	12
Straight-through transformers • Diameter of opening					
	mm	--	--	15	18

1) For version with straight-through transformer up to 1000 VAC.
2) For version with straight-through transformer up to 8 kV.

3) If two different conductor cross-sections are connected to one clamping point, both cross-sections must lie in the range specified.

Type	3RB20 56, 3RB21 53	3RB20 66, 3RB21 63
Size	S6	S10/S12
Width	120 mm	145 mm
Main circuit		
Rated insulation voltage U_i (pollution degree 3)	V	1000
Rated impulse withstand voltage U_{imp}	kV	8
Rated operational voltage U_e	V	1000
Type of current	No	
• Direct current	Yes, 50/60 Hz \pm 5 (other frequencies on request)	
• Alternating current		
Set current	A	50 ... 200
		55 ... 250 to 160 ... 630
Power loss per unit (max.)	W	0.05
Short-circuit protection	See Selection and Ordering Data	
- With fuse without contactor	See Technical Specifications (short-circuit protection with fuses for motor feeders)	
- With fuse and contactor		
Safe isolation between main and auxiliary conducting path according to IEC 60947-1	V	690 ¹⁾
Connection for main circuit		
Electrical connection version	Screw terminal with box terminal/ Bus connection / Straight-through transformer	Screw terminal with box terminal/ Bus connection
Screw terminal		
• Terminal screw	4 mm Allen screw	5 mm Allen screw
• Tightening torque	Nm 10 ... 12	20 ... 22
• Conductor cross-sections (min./max.), 1 or 2 conductors		
- Solid	mm ² --	
- Finely stranded without end sleeve	mm ² With 3RT19 55-4G box terminal: 2 x (1 x max. 50, 1 x max. 70), 1 x (10 ... 70) With 3RT19 56-4G box terminal: 2 x (1 x max. 95, 1 x max. 120), 1 x (10 ... 120)	2 x (50 ... 185), front clamping point only: 1 x (70 ... 240) rear clamping point only: 1 x (120 ... 185)
- Finely stranded with end sleeve	mm ² With 3RT19 55-4G box terminal: 2 x (1 x max. 50, 1 x max. 70), 1 x (10 ... 70) With 3RT19 56-4G box terminal: 2 x (1 x max. 95, 1 x max. 120), 1 x (10 ... 120)	2 x (50 ... 185), front clamping point only: 1 x (70 ... 240) rear clamping point only: 1 x (120 ... 185)
- Stranded	mm ² With 3RT19 55-4G box terminal: 2 x (max. 70), 1 x (16 ... 70) With 3RT19 56-4G box terminal: 2 x (max. 120), 1 x (16 ... 120)	2 x (70 ... 240), front clamping point only: 1 x (95 ... 300) rear clamping point only: 1 x (120 ... 240)
- AWG conductors, solid or stranded	AWG With 3RT19 55-4G box terminal: 2 x (max. 1/0), 1 x (6 ... 2/0) With 3RT19 56-4G box terminal: 2 x (max. 3/0), 1 x (6 ... 250 kcmil)	2 x (2/0 ... 500 kcmil), front clamping point only: 1 x (3/0 ... 600 kcmil) rear clamping point only: 1 x (250 kcmil ... 500 kcmil)
- Ribbon cable conductors (number x width x circumference)	mm With 3RT19 55-4G box terminal: 2 x (6 x 15.5 x 0.8), 1 x (3 x 9 x 0.8 ... 6 x 15.5 x 0.8) With 3RT19 56-4G box terminal: 2 x (10 x 15.5 x 0.8), 1 x (3 x 9 x 0.8 ... 10 x 15.5 x 0.8)	2 x (20 x 24 x 0.5), 1 x (6 x 9 x 0.8 ... 20 x 24 x 0.5)
Busbar connections		
• Terminal screw	Nm M 8 x 25	M 10 x 30
• Tightening torque	Nm 10 ... 14	14 ... 24
• Conductor cross-section (min./max.)		
- Finely stranded with cable lug	mm ² 16 ... 95 ²⁾	50 ... 240 ³⁾
- Stranded with cable lug	mm ² 25 ... 120 ²⁾	70 ... 240 ³⁾
- AWG connections, solid or stranded, with cable lug	AWG 4 ... 250 kcmil	2/0 ... 500 kcmil
- With connecting bar (max. width)	mm 15	25
Straight-through transformers		
• Diameter of opening	mm 24.5	--
• Conductor cross-section (max.)		
- NYY	mm ² 120	--
- H07RN-F	mm ² 70	--

1) For grounded networks, otherwise 600 V.

2) When connecting cable lugs according to DIN 46235, use the 3RT19 56-4EA1 terminal cover for conductor cross-sections from 95 mm² to ensure phase spacing.

3) When connecting cable lugs according to DIN 46234 for conductor cross-sections from 240 mm² as well as DIN 46235 for conductor cross-sections from 185 mm², use the 3RT19 56-4EA1 terminal cover to ensure phase spacing.

Type	3RB30 16, 3RB31 13	3RB30 26, 3RB31 23	3RB30 36, 3RB31 33	3RB30 46, 3RB31 43	3RB30 56, 3RB31 53	3RB30 66, 3RB31 63
Size	S00	S0	S2	S3	S6	S10/S12
Width	45 mm	45 mm	55 mm	70 mm	120 mm	145 mm
Auxiliary circuit						
Number of NO contacts	1					
Number of NC contacts	1					
Auxiliary contacts – assignment	1 NO for the signal "tripped", 1 NC for switching off the contactor					
Rated insulation voltage U_i (pollution degree 3)	V	300				
Rated impulse withstand voltage U_{imp}	kV	4				
Auxiliary contacts – Contact rating						
• NC contact with alternating current AC-14/AC-15 Rated operational current I_e at U_e :						
- 24 V	A	4				
- 120 V	A	4				
- 125 V	A	4				
- 250 V	A	3				
• NO contact with alternating current AC-14/AC-15: Rated operational current I_e at U_e :						
- 24 V	A	4				
- 120 V	A	4				
- 125 V	A	4				
- 250 V	A	3				
• NC, NO contact with direct current DC-13: Rated operational current I_e at U_e :						
- 24 V	A	2				
- 60 V	A	0.55				
- 110 V	A	0.3				
- 125 V	A	0.3				
- 250 V	A	0.11				
• Continuous thermal current I_{th}	A	5				
• Contact reliability (suitability for PLC control; 17 V, 5 mA)		Yes				
Short-circuit protection						
• With fuse						
- gL/gG operational class	A	6				
Ground-fault protection (only 3RB31)						
• Tripping value I_{Δ}						
• Operating range I						
• Response time t_{trip} (in steady-state condition)	s	The information refers to sinusoidal residual currents at 50/60 Hz. > $0.75 \times I_{motor}$ Lower current setting value < I_{motor} < $3.5 \times$ upper current setting value < 1				
Integrated electrical remote RESET (only 3RB31)						
Connecting terminals A3, A4		24 V DC, max. 200 mA for approx. 20 ms, then < 10 mA				
Protective separation between main and auxiliary conducting path according to IEC 60947-1	V	300				
CSA, UL, and UR rated data						
Auxiliary circuit – switching capacity						
3RB30: B600, R300 3RB31: B300, R300				B300, R300		
Connection of the auxiliary circuit						
Connection type						
Screw terminal or spring-loaded terminals						
Screw terminal						
• Terminal screw						
• Tightening torque						
• Conductor cross-sections (min./max.), 1 or 2 conductors						
- Solid or stranded	mm ²	1 × (0.5 ... 4), 2 × (0.5 ... 2.5)				
- Finely stranded with end sleeve	mm ²	1 × (0.5 ... 2.5), 2 × (0.5 ... 1.5)				
- AWG conductors, solid or stranded	AWG	2 × (20 ... 14)				
Spring-loaded terminals						
• Conductor cross-sections (min./max.), 1 or 2 conductors						
- Solid	mm ²	2 × (0.25 ... 1.5)				
- Finely stranded without end sleeve	mm ²	--				
- Finely stranded with end sleeve	mm ²	2 × (0.25 ... 1.5)				
- Stranded	mm ²	2 × (0.25 ... 1.5)				
- AWG conductors, solid or stranded	AWG	2 × (24 ... 16)				

Short-circuit protection with fuses for motor starters

For short-circuit currents up to 50 kA at 400 to 690 V

Overload relays	Contactor	CLASS									690 V		
		5 and 10			20			30			Fuse links ¹⁾		
Setting range	Type	Rated operational current I_e AC-3 in A at									Type of coordination ²⁾		
		400 V	500 V	690 V	400 V	500 V	690 V	400 V	500 V	690 V	1	2	
Size S00													
0.1 ... 0.4 A	3RT20 15	0.4	0.4	0.4	0.4	0.4	0.4	0.4	0.4	0.4	0.4	35	4
0.32 ... 1.25 A	3RT20 15	1.25	1.25	1.25	1.25	1.25	1.25	1.25	1.25	1.25	1.25	35	6
1 ... 4 A	3RT20 15	4	4	4	4	4	4	4	4	4	4	35	20
	3RT20 16	4	4	4	4	4	4	4	4	4	4	35	20
	3RT20 17	4	4	4	4	4	4	4	4	4	4	35	20
4 ... 16 A	3RT20 16	9	6.5	5.2	9	6.5	5.2	9	6.5	5.2	35	20	
	3RT20 17	12	9	6.3	10	9	6.3	9	9	6.3	35	20	
	3RT20 18	16	12.4	8.9	12.9	11.6	8.1	11.6	11.6	8.1	50	25	
Size S0													
3 ... 12 A	3RT20 23	9	6.5	5.2	9	6.5	5.2	--	--	--	63	25	
	3RT20 24	12	12	9	12	12	9	12	12	9	63	25	
	3RT20 25	12	12		12	12	12	12	12	12	63	25	
10 ... 40	3RT20 24	12	12	9	12	12	9	12	12	9	63	25	
	3RT20 25	17	17	13	16	16	13	14	14	13	63	25	
	3RT20 26	25	18	13	16	16	13	14	14	13	100	35	
	3RT20 27	32	32	21	18.6	18.6	15.1	16.2	16.2	15.1	125	50	
	3RT20 28	38	32	21	22.4	22.4	18.2	19.6	19.6	18.2	125	50	
Size S2													
12.5 ... 50 A	3RT20 35	40	40	24	40	40	24	36	36	36	160	80	
	3RT20 36	50	50	24	45	45	24	38	38	24	160	80	
	3RT20 37	50	50	47	48	48	47	42	42	42	250	125	
	3RT20 38	50	50	50	49	49	49	43	43	43	250	160	
20 ... 80 A	3RT20 35	40	40	24	40	40	24	36	36	36	160	80	
	3RT20 36	50	50	24	45	45	24	38	38	24	160	80	
	3RT20 37	65	65	47	48	48	47	42	42	42	250	125	
	3RT20 38	80	80	58	49	49	49	43	43	43	250	160	
Size S3													
12.5 ... 50 A	3RT20 45	50	50	47	49	49	47	41.7	41.7	41.7	200	125	
	3RT20 46	50	50	50	50	50	50	45	45	45	200	160	
32 ... 115 A	3RT20 45	65	65	47	49	49	47	41.7	41.7	41.7	200	125	
	3RT20 46	80	80	58	53	53	53	45	45	45	200	160	
	3RT20 47	95	95	58	59	59	58	50	50	50	200	160	
	3RT10 54	100	100	100	81.7	81.7	81.7	69	69	69	355	315	
	3RT10 55	--	--	--	100	100	100	90	90	90	355	315	
Size S6													
50 ... 200 A	3RT10 54	115	115	115	81.7	81.7	81.7	69	69	69	355	315	
	3RT10 55	150	150	150	107	107	107	90	90	90	355	315	
	3RT10 56	185	185	170	131	131	131	111	111	111	355	315	
Size S10/S12													
55 ... 250 A	3RT10 64	225	225	225	160	160	160	135	135	135	500	400	
	3RT10 65	250	250	250	188	188	188	159	159	159	500	400	
	3RT10 66	250	250	250	213	213	213	180	180	180	500	400	
160 ... 630 A	3RT10 64	225	225	225	160	160	160	--	--	--	500	400	
	3RT10 65	265	265	265	188	188	188	--	--	--	500	400	
	3RT10 66	300	300	280	213	213	213	180	180	180	500	400	
	3RT10 75	400	400	400	284	284	284	240	240	240	630	400	
	3RT10 76	500	500	450	355	355	355	300	300	300	630	500	
	3RT12 64	225	225	225	225	225	225	173	173	173	500	500	
	3RT12 65	265	265	265	265	265	265	204	204	204	500	500	
	3RT12 66	300	300	300	300	300	300	231	231	231	500	500	
	3RT12 75	400	400	400	400	400	400	316	316	316	800	800	
	3RT12 76	500	500	500	500	500	500	385	385	385	800	800	
	3TF68 ³⁾	630	630	630	440	440	440	376	376	376	800	500 ⁴⁾	
	3TF69 ³⁾	630	630	630	572	572	572	500	500	500	800	630 ⁴⁾	

1) Please observe operational voltage.

2) Coordination and short-circuit equipment according to EN 60947-4-1:

Type of coordination 1: the contactor or starter must not endanger persons or the installation in the event of a short-circuit.

They do not need to be suitable for further operation without repair and the renewal of parts.

Type of coordination 2: the contactor or starter must not endanger persons or the installation in the event of a short-circuit.

They must be suitable for further operation. There is a risk of contact welding.

3) Contactor cannot be mounted.

4) Please ensure that the maximum AC-3 operational current has sufficient safety clearance from the rated current of the fuses.

Characteristic curves

The tripping characteristics show the relationship between the tripping time and tripping current as multiples of the set current I_e and are given for symmetrical three-pole and two-pole loads from the cold state.

The smallest current used for tripping is called the minimum tripping current. According to IEC 60947-4-1, this current must be within specified limits. The limits of the total tripping current for the 3RB20/3RB21 solid-state overload relays for symmetrical three-pole loads are between 105 % and 120 % of the set current.

The tripping characteristic starts with the minimum tripping current and continues with higher tripping currents based on the characteristics of the so-called trip classes (CLASS 10, CLASS 20 etc.). The trip classes describe time intervals within which the overload relays have to trip with 7.2 times the set current I_e from the cold state for symmetrical three-pole loads.

The tripping times according to IEC 60947-4-1, tolerance band E, are as follows for:

Trip class	Tripping time
CLASS 5	3 ... 5 s
CLASS 10	5 ... 10 s
CLASS 20	10 ... 20 s
CLASS 30	20 ... 30 s

The tripping characteristic for a three-pole overload relay from the cold state (see illustration 1) only apply if all three phases are simultaneously loaded with the same current. In the event of a phase failure the 3RB20/3RB21 solid-state overload relays switch off the contactor more quickly in order to minimize heating of the load in accordance with the tripping characteristic for two-pole loads from the cold state (see illustration 2). With phase unbalance the devices switch off depending on the reason for the unbalance between the two characteristic curves.

Compared with a cold load, a load at operating temperature obviously has a lower temperature reserve. The tripping time of the 3RB2/3RB3 solid-state overload relays is reduced therefore to about 30 % when loaded with the set current I_e for an extended period.

Tripping characteristics for 3-pole loads

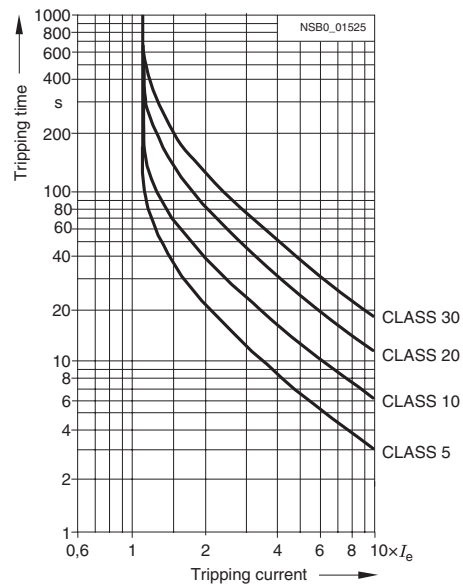

Illustration 1

Tripping characteristics for 2-pole loads

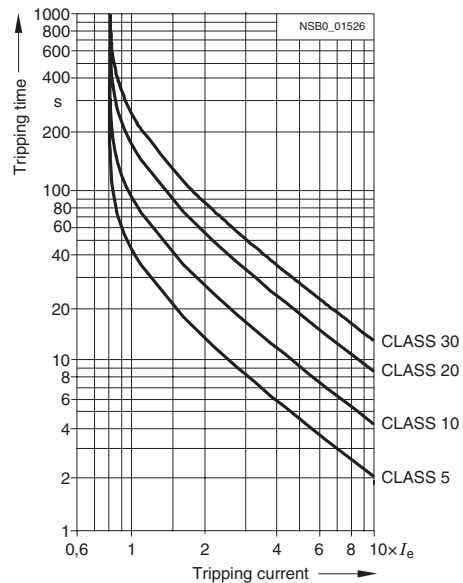

Illustration 2

The above illustrations are schematic representations of characteristic curves.

Overload Relays

3RB2 / 3RB3 Solid-State Overload Relays

3RB20, 3RB21, 3RB30, 3RB31 up to 630A for standard applications

Dimensional drawings

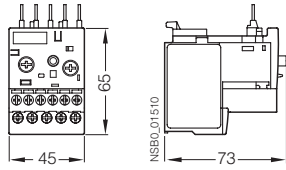

3RB30 16, 3RB31 13, size S00

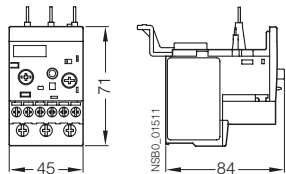

3RB30 26, 3RB31 23, size S0

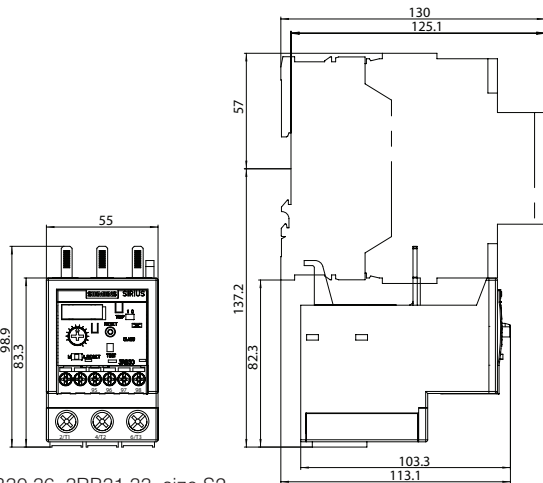

3RB30 36, 3RB31 33, size S2

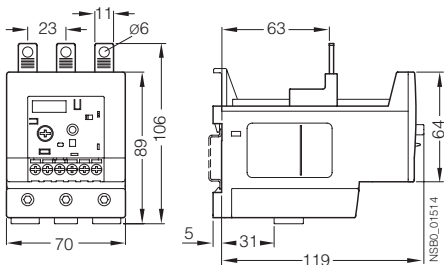

3RB30 46, 3RB31 43, size S3

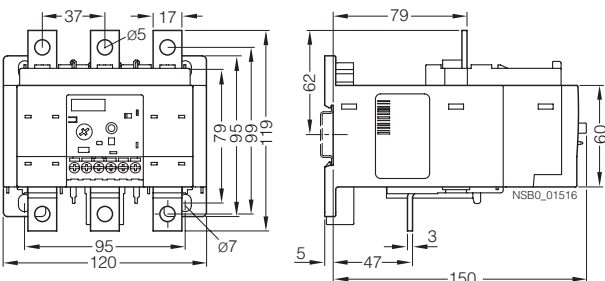

3RB20 56, 3RB21 53, size S6

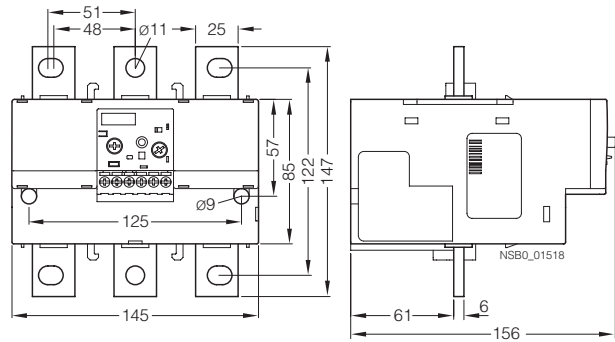

3RB20 66, 3RB21 63, size S10/S12

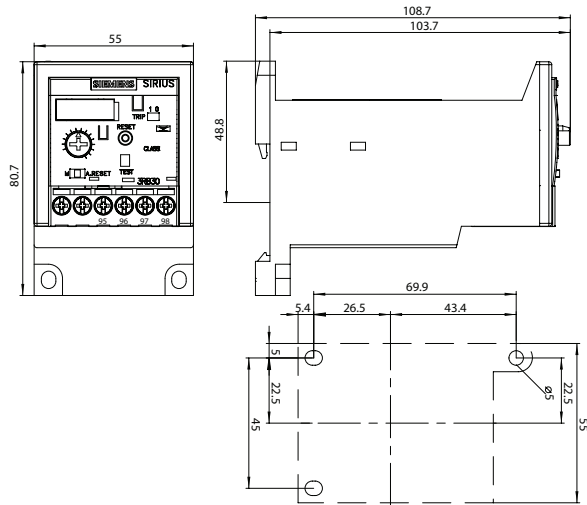

3RB30 36, 3RB31 33, size S2 with straight-through transformer

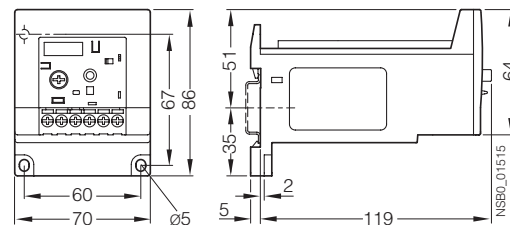

3RB30 46, 3RB31 43, size S3 with straight-through transformer

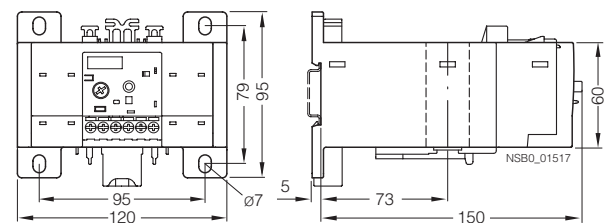

3RB20 56, 3RB21 53, size S6 with straight-through transformer

Overload Relays

3RB2 / 3RB3 Solid-State Overload Relays

3RB20, 3RB21, 3RB30, 3RB31 up to 630A for standard applications

Schematics

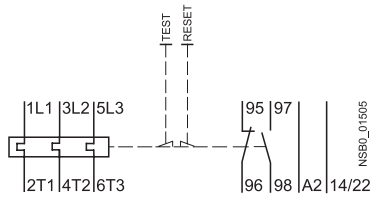

3RB30 16 overload relays

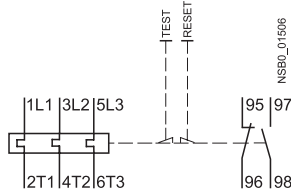

3RB30 26 to 3RB20 66 overload relays

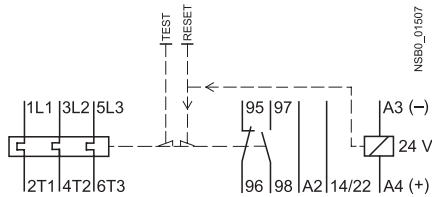

3RB31 13 overload relays

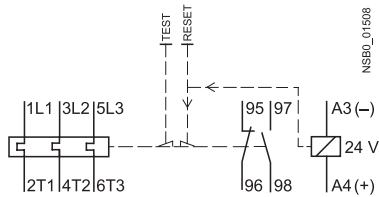

3RB31 23 to 3RB21 63 overload relays

Overview

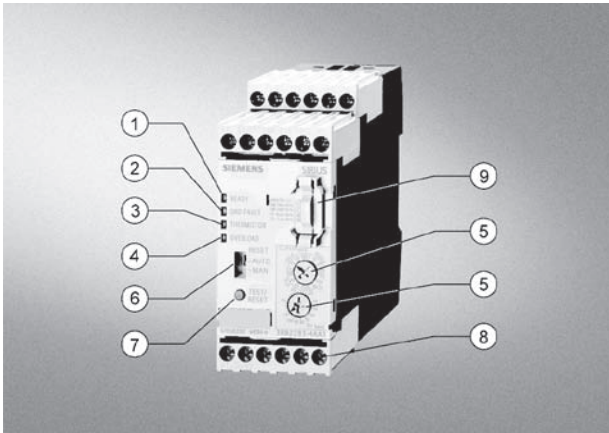

3RB22/3RB23 evaluation module

- (1) Green "Ready" LED:
A continuous green light signals that the device is working correctly.
- (2) Red "Ground Fault" LED:
A continuous red light signals a ground fault.
- (3) Red "Thermistor" LED:
A continuous red light signals an active thermistor trip.
- (4) Red "Overload" LED:
A continuous red light signals an active overload trip; a flickering red light signals an imminent trip (overload warning).
- (5) Motor current and trip class adjustment:
Setting the device to the motor current and to the required trip class dependent on the starting conditions is easy with the two rotary knobs.
- (6) Selector switch for manual/automatic RESET:
With this switch you can choose between manual and automatic RESET.
- (7) Test/RESET button:
Enables testing of all important device components and functions, plus resetting of the device after a trip when manual RESET is selected.
- (8) Connecting terminals (removable terminal block):
The generously sized terminals permit connection of two conductors with different cross-sections for the auxiliary, control and sensor circuits. Connection is possible with screw-type terminals and alternatively with spring-loaded terminals.
- (9) 3RB29 85 function expansion module:
Enables more functions to be added, e.g. internal ground fault detection and/or an analog output with corresponding signals.

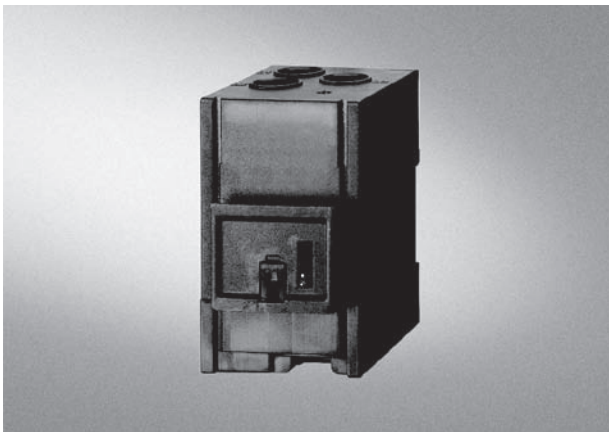

3RB29 06 current measuring module

The modular, solid-state overload relays with external power supply type 3RB22 (with monostable auxiliary contacts) and type 3RB23 (with bistable auxiliary contacts) up to 630 A (up to 820 A possible with a series transformer) have been designed for inverse-time delayed protection of loads with normal and heavy starting (see Function) against excessive temperature rises due to overload, phase unbalance or phase failure. An overload, phase unbalance or phase failure result in an increase of the motor current beyond the set motor rated current. This current rise is detected by means of a current measuring module and electronically evaluated by a special evaluation module which is connected to it. The evaluation electronics sends a signal to the auxiliary contacts. The auxiliary contacts then switch off the load by means of the contactors control circuit. The break time depends on the ratio between the tripping current and set current I_{e} and is stored in the form of a long-term stable tripping characteristic (see Characteristic Curves). The "tripped" status is signaled by means of a continuous red "Overload" LED.

The LED indicates imminent tripping of the relay due to overload, phase unbalance or phase failure by flickering when the limit current has been violated. This warning can also be used as a signal through auxiliary contacts.

In addition to the described inverse-time delayed protection of loads against excessive temperature rise, the 3RB22/3RB23 solid-state overload relays also allow direct temperature monitoring of the motor windings (full motor protection) by failsafe connection of a PTC sensor circuit. With this temperature-dependent protection, the loads can be protected against overheating caused indirectly by reduced coolant flow, for example, which cannot be detected by means of the current alone. In the event of overheating, the devices signal the contactor to switch off, and thus the load, by means of the auxiliary contacts. The "tripped" status is signaled by means of a continuous red "Thermistor" LED.

To also protect the loads against high-resistance short-circuits due to damage to the insulation, humidity, condensed water, etc., the 3RB22/3RB23 solid-state overload relays offer the possibility of internal ground fault monitoring in conjunction with a function expansion module; not possible in conjunction with a contactor assembly for Wye-Delta starting). In the event of a ground fault the 3RB22/3RB23 relays trip instantaneously. The "tripped" status is signaled by means of a red "Ground Fault" LED. Signaling through auxiliary contacts is also possible.

After tripping due to overload, phase unbalance, phase failure, thermistor tripping or ground fault, the relay may be reset manually or automatically after the recovery time has elapsed (see Function).

In conjunction with a function expansion module the motor current measured by the microprocessor can be output in the form of an analog signal 4 ... 20 mA DC for operating rotary coil instruments or for feeding into analog inputs of programmable logic controllers. With an additional AS-Interface analog module the current values can also be transferred over the AS-i bus system.

The devices are manufactured in accordance with environmental guidelines and contain environmentally friendly and reusable materials.

They comply with important worldwide standards and approvals.

Benefits

The most important features and benefits of the 3RB22/3RB23 solid-state overload relays are listed in the overview table (see [Overload Relays, General Data](#)).

Application

Industries

The 3RB22/3RB23 solid-state overload relays are suitable for customers from all industries who want to provide optimum inverse-time delayed and temperature-dependent protection of their electrical loads (e.g. motors) under normal and heavy starting conditions (CLASS 5 to CLASS 30), minimize project completion times, inventories and power consumption, and optimize plant availability and maintenance management.

Application

The 3RB22/3RB23 solid-state overload relays have been designed for the protection of three-phase asynchronous and single-phase AC motors.

If single-phase AC motors are to be protected by the 3RB22/3RB23 solid-state overload relays, the main circuits of the current measuring modules must be series-connected.

Ambient conditions

The devices are insensitive to external influences such as shocks, corrosive environments, ageing and temperature changes.

For the temperature range from -25 °C to $+60\text{ °C}$, the 3RB22/3RB23 solid-state overload relays compensate the temperature according to IEC 60947-4-1.

Configuration notes for use of the devices below -25 °C or above $+60\text{ °C}$ on request.

"Increased safety" type of protection EEx e according to ATEX guideline 94/9/EC

The 3RB22/3RB23 solid-state overload relays are suitable for the overload protection of explosion-proof motors with "increased safety" type of protection EEx e. The relays meet the requirements of EN 60079-7 (Electrical apparatus for potentially explosive atmospheres – Increased safety "e").

When using 3RB23 solid-state overload relays for the protection of EEx e motors, separate monitoring of the control supply voltage is recommended.

The basic safety and health requirements of ATEX guideline 94/9/EG are fulfilled by compliance with

- EN 60947-1
- EN 60947-4-1
- EN 60947-5-1
- EN 60079-14

EU type test certificate for Group II, Category (2) G/D under application. Number on request.

Accessories

The following accessories are available for the 3RB22/3RB23 solid-state overload relays:

- A sealable cover for the evaluation module
- Box terminal blocks for the current measuring modules size S6 and S10/S12
- Terminal covers for the current measuring modules size S6 and S10/S12
- Push-in lugs for screw (panel) mounting the size S00 to S3 current measuring modules

3RB2 Solid-State Overload Relays



3RB22, 3RB23 for high-feature applications

3RB22/3RB23 solid-state overload relays for full motor protection with screw connection or spring-loaded terminals for stand-alone installation, CLASS 5, 10, 20 and 30 adjustable

Features and technical specifications:

- Overload protection, phase failure protection and unbalance protection
- External power supply 24 ... 240 V AC/DC
- Auxiliary contacts 2 NO +2 NC
- Manual and automatic RESET
- Electrical remote RESET integrated
- 4 LEDs for operating and status displays
- TEST function and self-monitoring
- Internal ground fault detection with function expansion module
- Screw connection or spring-loaded terminals for auxiliary, control and sensor circuits
- Input for PTC sensor circuit
- Analog output with function expansion module

Size Contactor	Version	Connection type	Order No.	Weight per PU approx. kg
----------------	---------	-----------------	-----------	--------------------------

Evaluation modules					
 <p>3RB2. 83-4AA1</p>	S00 ... S12	Monostable	Screw connection	3RB22 83-4AA1	0.300
				Spring-loaded terminals	3RB22 83-4AC1
		Bistable	Screw connection	3RB23 83-4AA1	0.300
			Spring-loaded terminals	3RB23 83-4AC1	0.300
 <p>3RB2. 83-4AC1</p>					

Function expansion modules					
–		Analog Basic 1 module¹⁾ Analog output DC 4 ... 20 mA, with overload warning		3RB29 85-2AA0	0.030
		Analog Basic 1 GF module¹⁾²⁾ Analog output DC 4 ... 20 mA, with internal ground fault detection and overload warning		3RB29 85-2AA1	0.030
		Analog Basic 2 GF module¹⁾²⁾ Analog output DC 4 ... 20 mA, with internal ground fault detection and ground fault signaling		3RB29 85-2AB1	0.030
		Basic 1 GF module²⁾ with internal ground fault detection and overload warning		3RB29 85-2CA1	0.030
		Basic 2 GF module²⁾ with internal ground fault detection and ground fault signaling		3RB29 85-2CB1	0.030

- 1) The analog signal 4 ... 20 mA DC can be used for operating rotary coil instruments or for feeding into analog inputs of programmable logic controllers.
- 2) The following information on ground fault protection refers to sinusoidal residual currents at 50/60 Hz:
 - With a motor current of between 0.3 and 2 times the set current I_a the unit will trip at a ground fault current equal to 30% of the set current.
 - With a motor current of between 2 and 8 times the set current I_a the unit will trip at a ground fault current equal to 15% of the set current.
 - The trip delay amounts to between 0.5 and 1 second.

Note: Analog input modules, e. g. SM 331, must be configured for 4-wire measuring transducers. In this case the analog input module must not supply current to the analog output of the 3RB22/ 3RB23 relay.





For accessories, see page 3/35
 For description, see pages 3/32-3/33
 For technical data, see pages 3/39-3/44.
 For dimension drawings, see pages 3/45-3/46.
 For schematic diagrams, see page 3/47.

Overload Relays

3RB2 Solid-State Overload Relays

3RB22, 3RB23 for high-feature applications

Current measuring modules for direct mounting¹⁾ and stand-alone installation¹⁾²⁾

Size Con-factor ³⁾	Set current value of the inverse-time delayed overload trip A	Order No.	Weight per PU approx. kg
Size S00/S0²⁾⁴⁾			
 3RB29 06-2.G1	S00/S0	0.3 ... 3	3RB29 06-2BG1 0.100
		2.4 ... 25	3RB29 06-2DG1 0.150
Size S2/S3²⁾⁴⁾			
 3RB29 06-2.JG1	S2/S3	10 ... 100	3RB29 06-2JG1 0.350
Size S6¹⁾⁴⁾			
 3RB29 56-2.TG2	S6	20 ... 200	3RB29 56-2TG2 0.600
		with pass through CT's with busbar	3RB29 56-2TH2 1.000
Size S10/S12¹⁾			
 3RB29 66-2.WH2	S10/S12 and size 14 (3TF68/ 3TF69)	63 ... 630	3RB29 66-2WH2 1.750

- 1) The current measuring modules with an Order No. ending with "2" are designed for direct mounting and stand-alone installation. For 3TF68/3TF69 contactors, direct mounting is not possible.
2) The current measuring modules with an Order No. ending with "1" are designed for stand-alone installation.

- 3) Observe maximum rated operational current of the devices.
4) The modules with an Order No. with "G" in 11th position are equipped with a straight-through transformer.

Size Contactor	Version	Order No.	Weight per PU approx. kg
Connecting cables (essential accessory)			
 3RB29 87-2.	S00 ... S12	For connection between evaluation module and current measuring module	
		<ul style="list-style-type: none"> Length 0.1 m Length 0.5 m 	3RB29 87-2B 0.010 3RB29 87-2D 0.020

For description, see pages 3/36-3/37.
For technical data, see pages 3/39-3/44.
For dimension drawings, see pages 3/45-3/46.
For schematic diagrams, see page 3/47.

Design

Device concept

The 3RB22/3RB23 solid-state overload relays are based on a modular device concept. Each device always comprises an evaluation module, which is independent of the motor current, and a current measuring module, which is dependent on the motor current. The two modules are electrically interconnected by a connection cable through the system interface.

The basic functionality of the evaluation module can be optionally expanded with corresponding function expansion modules. The function expansion modules are integrated in the evaluation module for this purpose through a simple plug connection.

Mounting options

Current measuring modules

The current measuring modules size S00/S0 and S2/S3 are designed for stand-alone installation. By contrast, the current measuring modules size S6 and S10/S12 are suitable for stand-alone installation or direct mounting.

Evaluation modules

The evaluation modules can be mounted either on the current measuring module (only sizes S00/S0 and S2/S3) or separately.

Connection technique

Main circuit (current measuring module)

For sizes S00/S0, S2/S3 and S6, the main circuit can also be connected by the straight-through transformer method. In this case, the cables of the main circuit are routed directly through the feed-through openings of the relay to the contactor terminals.

For sizes S6 and S10/S12, the main circuit can be connected with the help of the Busbar. In conjunction with the corresponding box terminals, screw terminals are also available.

Auxiliary circuit (evaluation module)

Connection of the auxiliary circuit (removable terminal block) is possible with either screw terminals or spring-loaded terminals.

Overload relays in contactor assemblies for Wye-Delta starting

When overload relays are used in combination with contactor assemblies for Wye-Delta starting it must be noted that only 0.58 times the motor current flows through the line contactor. An overload relay mounted onto the line contactor must be set to 0.58 times the motor current.

When 3RB22/3RB23 solid-state overload relays are used in combination with contactor assemblies for Wye-Delta starting, the function expansion modules for internal ground-fault detection must not be used.

Operation with frequency converter

The 3RB22/3RB23 solid-state overload relays are suitable for frequencies of 50/60 Hz and the associated harmonics. This permits the 3RB22/3RB23 overload relays to be used on the incoming side of the frequency converter.

If motor protection is required on the outgoing side of the frequency converter, the 3RN thermistor motor protection devices or the 3RU11 thermal overload relays are available for this purpose.

Function

Basic functions

The 3RB22/3RB23 solid-state overload relays are designed for:

- Inverse-time delayed protection of loads from overloading
- Inverse-time delayed protection of loads from phase unbalance
- Inverse-time delayed protection of loads from phase failure
- Temperature-dependent protection of loads by connecting a PTC sensor circuit
- Protection of loads from high-resistance short-circuits (internal ground-fault detection; detection of fault currents > 30 % of the set current I_e)
- Output of an overload warning
- Output of an analog signal 4 to 20 mA DC as image of the flowing motor current

The basic functions of the evaluation modules in conjunction with function expansion modules are listed in the following table:

Evaluation module	Function expansion module	Basic functions
3RB22 83-4AA1 3RB22 83-4AC1 3RB23 83-4AA1 3RB23 83-4AC1	None	Inverse-time delayed protection, temperature-dependent protection, electrical remote RESET, overload warning
	3RB29 85-2CA1	Inverse-time delayed protection, temperature-dependent protection, internal ground-fault detection, electrical remote RESET, overload warning
	3RB29 85-2CB1	Inverse-time delayed protection, temperature-dependent protection, internal ground-fault detection, electrical remote RESET, ground fault signal
	3RB29 85-2AA0	Inverse-time delayed protection, temperature-dependent protection, electrical remote RESET, overload warning, analog output
	3RB29 85-2AA1	Inverse-time delayed protection, temperature-dependent protection, internal ground-fault detection, electrical remote RESET, overload warning, analog output
	3RB29 85-2AB1	Inverse-time delayed protection, temperature-dependent protection, internal ground-fault detection, electrical remote RESET, ground fault signal, analog output

Control circuit

The 3RB22/3RB23 solid-state overload relays require an external power supply (24–240 V AC/DC), i.e. an additional supply voltage is necessary.

Short-circuit protection

Fuses or motor starter protectors must be used for short-circuit protection. For assignments of the corresponding short-circuit protection devices to the 3RB22/3RB23 solid-state overload relays with/without contactor see [Technical Specifications and Selection and Ordering Data](#).

Trip classes

The 3RB22/3RB23 solid-state overload relays are suitable for normal and heavy starting. The required trip class (CLASS 5, 10, 20 or 30) can be adjusted by means of a rotary knob depending on the current starting condition.

For details of the trip classes see [Characteristic Curves](#).

3RB2 Solid-State Overload Relays

3RB22, 3RB23 for high-feature applications

Phase failure protection

The 3RB22/3RB23 solid-state overload relays are fitted with phase failure protection (see [Characteristic Curves](#)) in order to minimize temperature rises of the load during single-phase operation.

Setting

The 3RB22/3RB23 solid-state overload relays are set to the motor rated current by means of two rotary knobs.

- The upper rotary knob (CLASS/ $I_{e\max}$) is divided into 4 ranges: 1 A, 10 A, 100 A and 1000 A. The zone must be selected which corresponds to the rated motor current and the current measuring module to be used with it. With the range selected the required trip class (CLASS 5, 10, 20 or 30) can be determined.
- The lower rotary knob with percent scale (10 % ... 100 %) is then used to set the rated motor current in percent of the range selected with the upper rotary button.

Example

- Rating of induction motor = 45 kW (50 Hz, 400 V AC)
- Rated motor current = 80 A
- Required trip class = CLASS 20
- Selected transformer: 10 to 100 A

Solution

- Step 1: Use the upper rotary knob (CLASS) to select the 100 A range
- Step 2: Within the 100 A range set the trip class CLASS 20
- Step 3: Set the lower rotary knob to 80 % (= 0.8) of 100 A \times 0.8 = 80 A.

If the current which is set on the evaluation module does not correspond to the current range of the connected current transformer, an error will result.

Manual and automatic reset

In the case of the 3RB22/3RB23 solid-state overload relays, a slide switch can be used to choose between automatic and manual resetting.

If manual reset is set, a reset can be carried out directly on the device after a trip by pressing the blue TEST/RESET button. A remote RESET can be carried out electrically by jumpering the terminals Y1 and Y2.

If the slide switch is set to automatic RESET, the relay is reset automatically.

The time between tripping and resetting is determined by the recovery time.

Recovery time

With the 3RB22/3RB23 solid-state overload relays the recovery time after inverse-time delayed tripping is approx. 3 minutes regardless of the selected reset mode. The recovery time allows the load to cool down.

However, in the event of temperature-dependent tripping by means of a connected PTC thermistor sensor circuit, the device can only be manually or automatically reset once the winding temperature at the installation location of the PTC thermistor has fallen 5 Kelvin below its response temperature.

After a ground fault trip the 3RB22/3RB23 solid-state overload relay trips can be reset immediately without a recovery time.

TEST function

The combined TEST/RESET button can be used to check whether the relay is working correctly. The test can be aborted at any time by letting go of the TEST/RESET button.

LEDs, the device configuration (this depends on which expansion module is plugged in) and the device hardware are tested while the button is kept pressed for 6 seconds. Simultaneously and for another 18 seconds a direct current proportional in size to the maximum phase of the main current is fed in at the terminals I(+) and I(-). By comparing the analog signal, which is to be measured, with the main current, the accuracy of the current measurement can be determined. In this case 4 mA corresponds to 0 % and 20 mA to 125 % of the set current. After 24 seconds the auxiliary contacts are switched and the feeder switch off as the result, bringing the test to an end.

After a test trip a faultless relay is reset by pressing the TEST/RESET button. If a hardware fault is detected, the device trips and cannot be reset.

Self-monitoring

The 3RB22/3RB23 solid-state overload relays have a self-monitoring feature, i.e. the devices constantly monitor their own basic functions and trip if an internal fault is detected.

Display of the operating status

The particular operating status of the 3RB22/3RB23 solid-state overload relays is displayed by means of four LEDs:

- Green "Ready" LED: A continuous green light signals that the overload relay is ready for operation. The 3RB22/3RB23 overload relays are not ready (LED "OFF") if there is no control supply voltage or if the function test was negative.
- Red "Ground fault" LED: A continuous red light signals a ground fault.
- Red "Thermistor" LED: A continuous red light signals a temperature-dependent trip.
- Red "Overload" LED: A continuous red light signals an inverse-time delayed trip; a flickering red light signals an imminent inverse-time delayed trip (overload warning).

Auxiliary contacts

The 3RB22/3RB23 solid-state overload relays have two outputs, each with one NO contact and one NC contact. Their basic assignment/function may be influenced by function expansion modules.

The 3RB22 and 3RB23 differ with respect to the tripping characteristics of their auxiliary contacts – monostable or bistable:

The monostable 3RB22 solid-state overload relays will enter the "tripped" state if the control supply voltage fails (> 200 ms), and return to the original state they were in before the control supply voltage failed when the voltage returns. These devices are therefore especially suited for plants in which the control voltage is not strictly monitored.

The bistable 3RB23 overload relays do not change their "tripped" or "not tripped" status if the control voltage fails. The auxiliary contacts only switch over in the event of an overload and if the supply voltage is present. These devices are therefore especially suited for plants in which the control voltage is monitored separately.

Response if the control supply voltage fails

If the control supply voltage fails for more than 0.2 s, the output relays respond differently depending on the version: Monostable or bistable.

Overload Relays

3RB2 Solid-State Overload Relays

3RB22, 3RB23 for high-feature applications

Response of the output relays in the event of	Monostable 3RB22	Bistable 3RB23
Failure of the control supply voltage	The device trips	No change of the switching status of the auxiliary contacts
Return of the control supply voltage without previous tripping	The device resets	No change of the switching status of the auxiliary contacts
Return of the control supply voltage after previous tripping	The device remains tripped Reset: <ul style="list-style-type: none"> • For overload tripping, after 3 minutes • For thermistor tripping, after the temperature has fallen 5 K below the response temperature • For ground-fault tripping, immediately 	The device remains tripped Reset: <ul style="list-style-type: none"> • For overload tripping, after 3 minutes • For thermistor tripping, after the temperature has fallen 5 K below the response temperature • For ground-fault tripping, immediately

Monostable and bistable responses of the output relays

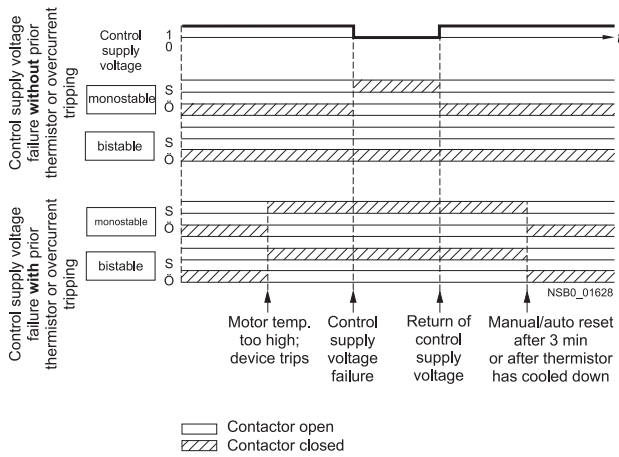



Technical specifications

The following technical information is intended to provide an initial overview of the various types of device and functions.

Detailed information, see

- Reference Manual "Protection Equipment – 3RU1, 3RB2 Overload Relays", <http://support.automation.siemens.com/WWW/view/en/35681297>

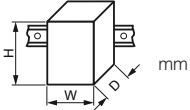
- or specific information on a particular article number via the product data sheet, <http://support.automation.siemens.com/WWW/view/en/20357046/133200>

Type – Overload relay: evaluation modules		3RB2283-4A.1	3RB2383-4A.1
Size contactor		S00 ... S10/S12	
Dimensions of evaluation modules (W x H x D)		45 x 111 x 95	
General data			
Trips in the event of		Overload, phase failure and phase unbalance (> 40 % according to NEMA), + ground fault (with corresponding function expansion module) and activation of the thermistor motor protection (with closed PTC sensor circuit)	
Trip class acc. to IEC 60947-4-1	CLASS	5, 10, 20 and 30 adjustable	
Phase failure sensitivity		Yes	
Overload warning		Yes, from $1.125 \times I_e$ for symmetrical loads and from $0.85 \times I_e$ for unsymmetrical loads	
Reset and recovery		Manual, automatic and remote RESET	
• Reset options after tripping			
• Recovery time			
- For automatic RESET	min.	- for tripping due to overcurrent: 3 (stored permanently) - for tripping by thermistor: time until the motor temperature has fallen 5 K below the response temperature	
- For manual RESET	min.	- for tripping due to a ground fault: no automatic RESET - for tripping due to overcurrent: 3 (stored permanently) - for tripping by thermistor: time until the motor temperature has fallen 5 K below the response temperature	
- For remote RESET	min.	- for tripping due to a ground fault: Immediately - for tripping due to overcurrent: 3 (stored permanently) - for tripping by thermistor: time until the motor temperature has fallen 5 K below the response temperature	
- For remote RESET	min.	- for tripping due to a ground fault: Immediately	
Features			
• Display of operating state on device		Yes, with four LEDs: - green LED "Ready" - red LED "Ground Fault" - red LED "Thermistor" - red LED "Overload"	
• TEST function		Yes, test of LEDs, electronics, auxiliary contacts and wiring of control circuit by pressing the button TEST/RESET / self-monitoring	
• RESET button		Yes, with the TEST/RESET button	
• STOP button		No	
Protection and operation of explosion-proof motors			
EC type test certificate number according to directive 94/9/EC (ATEX)		PTB 05 ATEX 3022  II (2) GD, see http://support.automation.siemens.com/WWW/view/en/23115758	--
Ambient temperatures			
• Storage/transport	°C	-40 ... +80	
• Operation	°C	-25 ... +60	
• Temperature compensation	°C	+60	
• Permissible rated current			
- Temperature inside control cabinet 60 °C	%	100	
- Temperature inside control cabinet 70 °C	%	On request	
Degree of protection acc. to IEC 60529		IP20: Current measuring modules in sizes S6 and S10/S12 with busbar connection in conjunction with cover.	
Touch protection acc. to IEC 61140		Finger-safe: Current measuring modules in sizes S6 and S10/S12 with busbar connection in conjunction with cover.	
Shock resistance with sine acc. to IEC 60068-2-27		g/ms	15/11
Electromagnetic compatibility (EMC) – Interference immunity			
• Conductor-related interference			
- Burst acc. to IEC 61000-4-4 (corresponds to degree of severity 3)	kV	2 (power ports), 1 (signal port)	
- Surge acc. to IEC 61000-4-5 (corresponds to degree of severity 3)	kV	2 (line to earth), 1 (line to line)	
• Electrostatic discharge according to IEC 61000-4-2 (corresponds to degree of severity 3)	kV	8 (air discharge), 6 (contact discharge)	
• Field-related interference according to IEC 61000-4-3 (corresponds to degree of severity 3)	V/m	10	
Electromagnetic compatibility (EMC) – emitted interference		Degree of severity A according to EN 55011 (CISPR 11) and EN 55022 (CISPR 22)	

Type – Overload relay of current measuring module	3RB29	3RB29	3RB29	3RB29
Size	S00/S0	S2/S3	S6	S10/S12
Width	45 mm	55 mm	120 mm	145 mm
Main circuit				
Rated insulation voltage U_i (pollution degree 3)	V	1000	1000	
Rated impulse withstand voltage U_{imp}	kV	6	8	
Rated operational voltage U_e	V	690	1000	
Type of current		No		
• Direct current		Yes, 50/60 Hz \pm 5 % (other frequencies on request)		
• Alternating current				
Set current	A	0.3 ... 3; 2.4 ... 25	10 ... 100	20 ... 200 63 ... 630
Power loss per unit (max.)	W	0.5		
Short-circuit protection		See Selection and Ordering Data		
• With fuse without contactor		See Technical Specifications (short-circuit protection with fuses for motor feeders)		
• With fuse and contactor				
Safe isolation between main and auxiliary conducting path according to IEC 60947-1	V	690 ¹⁾		
Connection for main circuit				
Electrical connection version		Screw terminals with box terminal		
Screw terminal				
• Terminal screw	--		4 mm Allen screw	5 mm Allen screw
• Tightening torque	--		10 ... 12	20 ... 22
• Conductor cross-sections (min./max.), 1 or 2 conductors				
- Solid	mm ²	--	--	--
- Finely stranded without end sleeve	mm ²	--	With 3RT19 55-4G box terminal: 2 x (1 x max. 50, 1 x max. 70), 1 x (10 ... 70)	2 x (50 ... 185), front clamping point only: 1 x (70 ... 240)
			With 3RT19 56-4G box terminal: 2 x (1 x max. 95, 1 x max. 120), 1 x (10 ... 120)	rear clamping point only: 1 x (120 ... 185)
- Finely stranded with end sleeve	mm ²	--	With 3RT19 55-4G box terminal: 2 x (1 x max. 50, 1 x max. 70), 1 x (10 ... 70)	2 x (50 ... 185), front clamping point only: 1 x (70 ... 240)
			With 3RT19 56-4G box terminal: 2 x (1 x max. 95, 1 x max. 120), 1 x (10 ... 120)	rear clamping point only: 1 x (120 ... 185)
- Stranded	mm ²	--	With 3RT19 55-4G box terminal: 2 x (max. 70), 1 x (16 ... 70)	2 x (70 ... 240), front clamping point only: 1 x (95 ... 300)
			With 3RT19 56-4G box terminal: 2 x (max. 120), 1 x (16 ... 120)	rear clamping point only: 1 x (120 ... 240)
- AWG conductors, solid or stranded	AWG	--	With 3RT19 55-4G box terminal: 2 x (max. 1/0), 1 x (6 ... 2/0)	2 x (2/0 ... 500 kcmil), front clamping point only: 1 x (3/0 ... 600 kcmil)
			With 3RT19 56-4G box terminal: 2 x (max. 3/0), 1 x (6 ... 250 kcmil)	rear clamping point only: 1 x (250 kcmil ... 500 kcmil)
- Ribbon cable conductors (number x width x circumference)	mm	--	With 3RT19 55-4G box terminal: 2 x (6 x 15.5 x 0.8), 1 x (3 x 9 x 0.8 ... 6 x 15.5 x 0.8)	2 x (20 x 24 x 0.5), 1 x (6 x 9 x 0.8 ... 20 x 24 x 0.5)
			With 3RT19 56-4G box terminal: 2 x (10 x 15.5 x 0.8), 1 x (3 x 9 x 0.8 ... 10 x 15.5 x 0.8)	
Busbar connections				
• Terminal screw	Nm	--	M8 x 25	M10 x 30
• Tightening torque		--	10 ... 14	14 ... 24
• Conductor cross-section (min./max.)				
- Solid with cable lug	mm ²	--	16 ... 95 ²⁾	50 ... 240 ³⁾
- Stranded with cable lug	mm ²	--	25 ... 120 ²⁾	70 ... 240 ³⁾
- AWG connections, solid or stranded, with cable lug	AWG	--	4 ... 250 kcmil	2/0 ... 500 kcmil
- With connecting bar (max. width)	mm	--	15	25
Straight-through transformers				
• Diameter of opening	mm	7.5	14	25
• Conductor cross-section (max.)				
- NYY	mm ²	4)	4)	120
- H07RN-F	mm ²	4)	4)	70

1) For grounded networks, otherwise 600 V.

2) When connecting cable lugs according to DIN 46235, use the 3RT19 56-4EA1 terminal cover for conductor cross-sections from 95 mm² to ensure phase spacing.

3) When connecting cable lugs according to DIN 46234 for conductor cross-sections from 240 mm² as well as DIN 46235 for conductor cross-sections from 185 mm², use the 3RT19 56-4EA1 terminal cover to ensure phase spacing.

4) On request.

Overload Relays

3RB2 Solid-State Overload Relays

3RB22, 3RB23 for standard applications

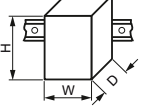

Type – Overload relay: evaluation modules		3RB2283-4A.1	3RB2383-4A.1
Size contactor		S00 ... S10/S12	
Dimensions of evaluation modules (W x H x D)	 mm	45 x 111 x 95	
General data (continued)			
Resistance to extreme climates – air humidity	%	100	
Dimensions		"Dimensional drawings", see • Reference Manual "Protection Equipment – 3RU1, 3RB2 Overload Relays", http://support.automation.siemens.com/WW/view/en/35681297 • Product data sheet, http://support.automation.siemens.com/WW/view/en/20357046/133200	
Installation altitude above sea level	m	Up to 2 000	
Mounting position		Any	
Type of mounting		Stand-alone installation	
• Evaluation modules		Size	
• Current measuring module		S00 to S3: Stand-alone installation, S6 and S10/S12: stand-alone installation or mounting onto contactors	
Type – Overload relay: evaluation modules		3RB2283-4A.1, 3RB2383-4A.1	
Size contactor		S00 ... S10/S12	
Auxiliary circuit			
Number of NO contacts		2	
Number of NC contacts		2	
Number of CO contacts		--	
Auxiliary contacts – assignment		<ul style="list-style-type: none"> • Alternative 1 <ul style="list-style-type: none"> - 1 NO for the signal "tripped by overload and/or thermistor" - 1 NC for disconnecting the contactor - 1 NO for the signal "tripped by ground fault" - 1 NC for disconnecting the contactor or¹⁾ • Alternative 2 <ul style="list-style-type: none"> - 1 NO for the signal "tripped by overload and/or thermistor and/or ground fault" - 1 NC for disconnecting the contactor - 1 NO for overload warning - 1 NC for disconnecting the contactor 	
Rated insulation voltage U_i (pollution degree 3)	V	300	
Rated impulse withstand voltage U_{imp}	kV	4	
Auxiliary contacts – contact rating			
• NC contact with alternating current AC-14/AC-15, rated operational current I_e at U_e			
- 24 V	A	6	
- 120 V	A	6	
- 125 V	A	6	
- 250 V	A	3	
• NO contact with alternating current AC-14/AC-15, rated operational current I_e at U_e			
- 24 V	A	6	
- 120 V	A	6	
- 125 V	A	6	
- 250 V	A	3	
• NC contact, NO contact with direct current DC-13, rated operational current I_e at U_e			
- 24 V	A	2	
- 60 V	A	0.55	
- 110 V	A	0.3	
- 125 V	A	0.3	
- 250 V	A	0.2	
• Conventional thermal current I_{th}	A	5	
• Contact reliability (suitability for PLC control; 17 V, 5 mA)		Yes	
Short-circuit protection			
• With fuse, operational class gG	A	6	
• With miniature circuit breaker, C characteristic	A	1.6	
Protective separation between auxiliary current paths acc. to IEC 60947-1	V	300	
CSA, UL, UR rated data			
Auxiliary circuit – switching capacity		B300, R300	

¹⁾ The assignment of auxiliary contacts may be influenced by function expansion modules.

Overload Relays

3RB2 Solid-State Overload Relays

3RB22, 3RB23 for standard applications

Type – Overload relay: evaluation modules		3RB2283-4A.1, 3RB2383-4A.1	
Size contactor		S00 ... S10/S12	
Control circuit			
Rated insulation voltage U_i (pollution degree 3)	V	300	
Rated impulse withstand voltage U_{imp}	kV	4	
Rated control supply voltage U_s			
• 50/60 Hz AC	V	24 ... 240	
• DC	V	24 ... 240	
Operating range			
• 50/60 Hz AC		$0.85 \times U_{s \min} \leq U_s \leq 1.1 \times U_{s \max}$	
• DC		$0.85 \times U_{s \min} \leq U_s \leq 1.1 \times U_{s \max}$	
Rated power			
• 50/60 Hz AC	W	0.5	
• DC	W	0.5	
Mains buffering time	ms	200	
Sensor circuit			
Thermistor motor protection (PTC thermistor sensor)			
• Summation cold resistance	k Ω	≤ 1.5	
• Response value	k Ω	3.4 ... 3.8	
• Return value	k Ω	1.5 ... 1.65	
Ground-fault detection			
The information refers to sinusoidal residual currents at 50/60 Hz.			
• Tripping value $I_A^{(1)}$			
- For $0.3 \times I_e < I_{motor} < 2.0 \times I_e$		$> 0.3 \times I_e$	
- For $2.0 \times I_e < I_{motor} < 8.0 \times I_e$		$> 0.15 \times I_{motor}$	
• Response time t_{trip}	ms	500 ... 1 000	
Analog output¹⁾²⁾			
Rated values			
• Output signal	mA	4 ... 20	
• Measuring range		0 ... $1.25 \times I_e$ 4 mA corresponds to $0 \times I_e$ 16.8 mA corresponds to $1.0 \times I_e$ 20 mA corresponds to $1.25 \times I_e$	
• Load, max.	Ω	100	
Conductor cross-sections for the auxiliary, control and sensor circuit as well as the analog output			
Connection type		 Screw terminals	
Terminal screw		M3, Pozidriv size 2	
Operating devices	mm	3.0 x 0.5	
Prescribed tightening torque	Nm	0.8 ... 1.2	
Conductor cross-sections (min./max.), 1 or 2 conductors can be connected			
• Solid or stranded	mm ²	$1 \times (0.5 \dots 4)^3, 2 \times (0.5 \dots 2.5)^3$	
• Finely stranded without end sleeve	mm ²	--	
• Finely stranded with end sleeve (DIN 46228-1)	mm ²	$1 \times (0.5 \dots 2.5)^3, 2 \times (0.5 \dots 1.5)^3$	
• AWG cables, solid or stranded	AWG	2 x (20 ... 14)	
Connection type		 Spring-type terminals	
Operating devices	mm	3.0 x 0.5	
Conductor cross-sections (min./max.), 1 or 2 conductors can be connected			
• Solid or stranded	mm ²	2 x (0.25 ... 1.5)	
• Finely stranded without end sleeve	mm ²	--	
• Finely stranded with end sleeve (DIN 46228-1)	mm ²	2 x (0.25 ... 1.5)	
• AWG cables, solid or stranded	AWG	2 x (24 ... 16)	

¹⁾ For the 3RB22 and 3RB23 overload relays in combination with a corresponding function expansion module.

²⁾ Analog input modules, e.g. SM 331, must be configured for 4-wire measuring transducers. In this case the analog input module must not supply current to the analog output of the 3RB22 and 3RB23 relay.

³⁾ If two different conductor cross-sections are connected to one clamping point, both cross-sections must be in the range specified.

Overload Relays

3RB2 Solid-State Overload Relays

3RB22, 3RB23 for standard applications

Short-circuit protection with fuses for motor feeders

For short-circuit currents up to 50 kA at 400 to 690 V

Overload relays	Contactor	CLASS									690 V		
		5 and 10			20			30			Fuse links ¹⁾		
Setting range	Type	Rated operational current I_e AC-3 in A at									gL/gG operational class		
		400 V	500 V	690 V	400 V	500 V	690 V	400 V	500 V	690 V	1	2	
Size S00/S0													
0.3 ... 3 A	3RT20 15	3	3	3	3	3	3	3	3	3	3	35	20
	3RT20 16	3	3	3	3	3	3	3	3	3	3	35	20
2.4 ... 25 A	3RT20 15	7	5	4	7	5	4	7	5	4	35	20	
	3RT20 16	9	6.5	5.2	9	6.5	5.2	9	6.5	5.2	35	20	
	3RT20 17	12	9	6.3	10	9	6.3	9	9	6.3	35	20	
	3RT20 23	9	6.5	5.2	9	6.5	5.2	--	--	--	63	25	
	3RT20 24	12	12	9	12	12	9	12	12	9	63	25	
	3RT20 25	17	17	13	16	16	13	14	14	13	63	25	
	3RT20 26	25	18	13	16	16	13	14	14	13	100	35	
Size S2/S3													
On request	3RT20 35	On request											
	3RT20 36	On request											
	3RT20 45	On request											
	3RT20 46	On request											
	3RT20 47	On request											
Size S6													
20 ... 200 A	3RT10 54	115	115	115	81.7	81.7	81.7	69	69	69	355	315	
	3RT10 55	150	150	150	107	107	107	90	90	90	355	315	
	3RT10 56	185	185	170	131	131	131	111	111	111	355	315	
Size S10/S12													
160 ... 630 A	3RT10 64	225	225	225	160	160	160	135	135	135	500	400	
	3RT10 65	265	265	265	188	188	188	159	159	159	500	400	
	3RT10 66	300	300	280	213	213	213	180	180	180	500	400	
	3RT10 75	400	400	400	284	284	284	240	240	240	630	400	
	3RT10 76	500	500	450	355	355	355	300	300	300	630	500	
	3RT12 64	225	225	225	225	225	225	173	173	173	500	500	
	3RT12 65	265	265	265	265	265	265	204	204	204	500	500	
	3RT12 66	300	300	300	300	300	300	231	231	231	500	500	
	3RT12 75	400	400	400	400	400	400	316	316	316	800	800	
	3RT12 76	500	500	500	500	500	500	385	385	385	800	800	
	3TF68 ³⁾	630	630	630	440	440	440	376	376	376	800	500 ⁴⁾	
	3TF69 ³⁾	630	630	630	572	572	572	500	500	500	800	630 ⁴⁾	

1) Please observe operational voltage.

2) Coordination and short-circuit equipment according to EN 60947-4-1:

Type of coordination 1: the contactor or starter must not endanger persons or the installation in the event of a short-circuit.

They do not need to be suitable for further operation without repair and the renewal of parts.

Type of coordination 2: the contactor or starter must not endanger persons or the installation in the event of a short-circuit.

They must be suitable for further operation. There is a risk of contact welding.

3) Contactor cannot be mounted.

4) Please ensure that the maximum AC-3 operational current has sufficient safety clearance from the rated current of the fuses.

Characteristic curves

The tripping characteristics show the relationship between the tripping time and tripping current as multiples of the set current I_e and are given for symmetrical three-pole and two-pole loads from the cold state.

The smallest current used for tripping is called the minimum tripping current. According to IEC 60947-4-1, this current must be within specified limits. The limits of the minimum tripping current for the 3RB22/3RB23 solid-state overload relays for symmetrical three-pole loads are between 105 % and 120 % of the set current.

The tripping characteristic starts with the minimum tripping current and continues with higher tripping currents based on the characteristics of the so-called trip classes (CLASS 10, CLASS 20 etc.). The trip classes describe time intervals within which the overload relays have to trip with 7.2 times the set current I_e from the cold state for symmetrical three-pole loads.

The tripping times according to IEC 60947-4-1, tolerance band E, are as follows for:

Trip class	Tripping time
CLASS 5	3 ... 5 s
CLASS 10	5 ... 10 s
CLASS 20	10 ... 20 s
CLASS 30	20 ... 30 s

The tripping characteristic for a three-pole overload relay from the cold state (see illustration 1) only apply if all three phases are simultaneously loaded with the same current. In the event of a phase failure or a current unbalance of more than 40 %, the 3RB22/3RB23 solid-state overload relays switch off the contactor more quickly in order to minimize heating of the load in accordance with the tripping characteristic for two-pole loads from the cold state (see illustration 2).

Compared with a cold load, a load at operating temperature obviously has a lower temperature reserve. The tripping time of the 3RB22/3RB23 solid-state overload relays are reduced therefore to about 30 % when loaded with the set current I_e for an extended period.

Tripping characteristics for 3-pole loads

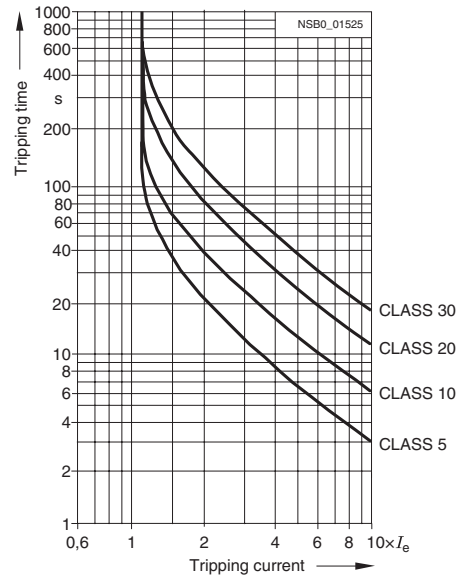

Illustration 1

Tripping characteristics for 2-pole loads

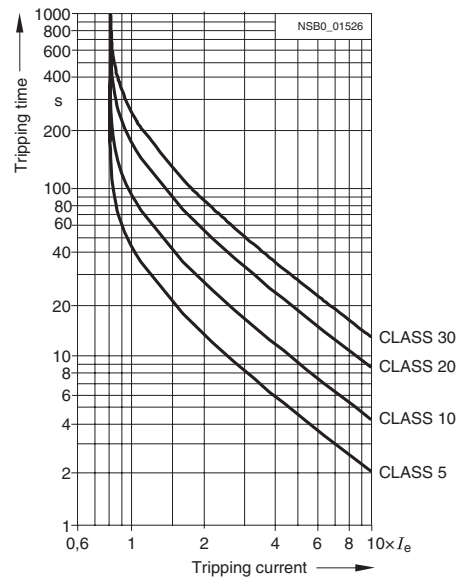

Illustration 2

The above illustrations are schematic representations of characteristic curves. The characteristic curves of the individual 3RB22/3RB23 solid-state overload relays can be requested from Technical Assistance at the following e-mail address:

Technical-assistance@siemens.com

Overload Relays

3RB2 Solid-State Overload Relays

3RB22, 3RB23 for standard applications

Dimensional drawings

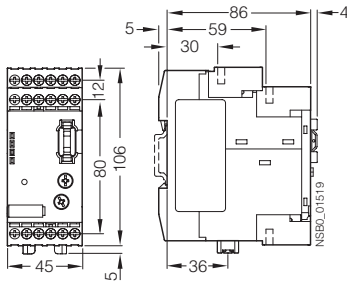

3RB22 83-4, 3RB23 83-4 evaluation module

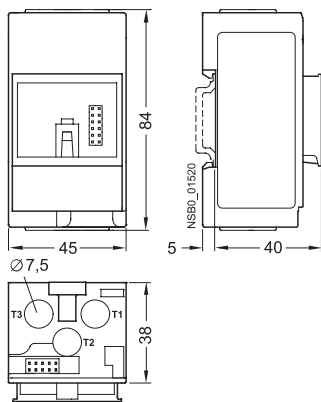

3RB29 06-2BG1, 3RB29 06-2DG1 current measuring module

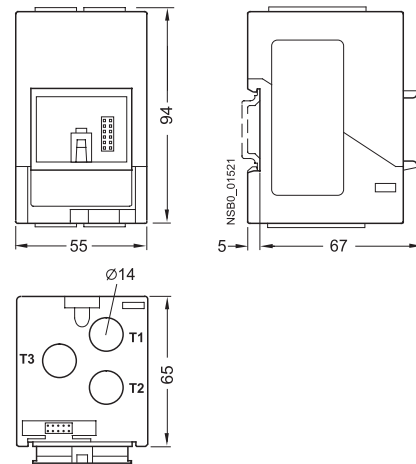

3RB29 06-2JG1 current measuring module

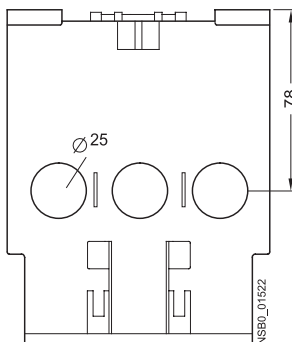
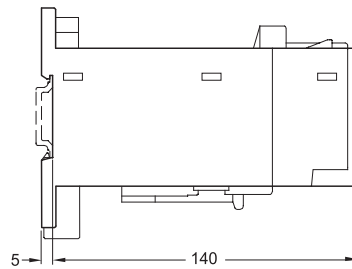
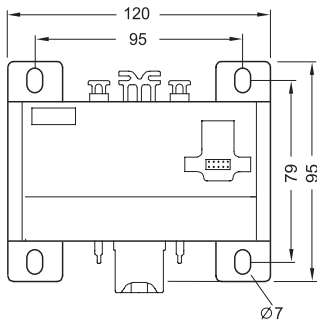

3RB29 56-2TG2 current measuring module

Overload Relays

3RB2 Solid-State Overload Relays

3RB22, 3RB23 for standard applications

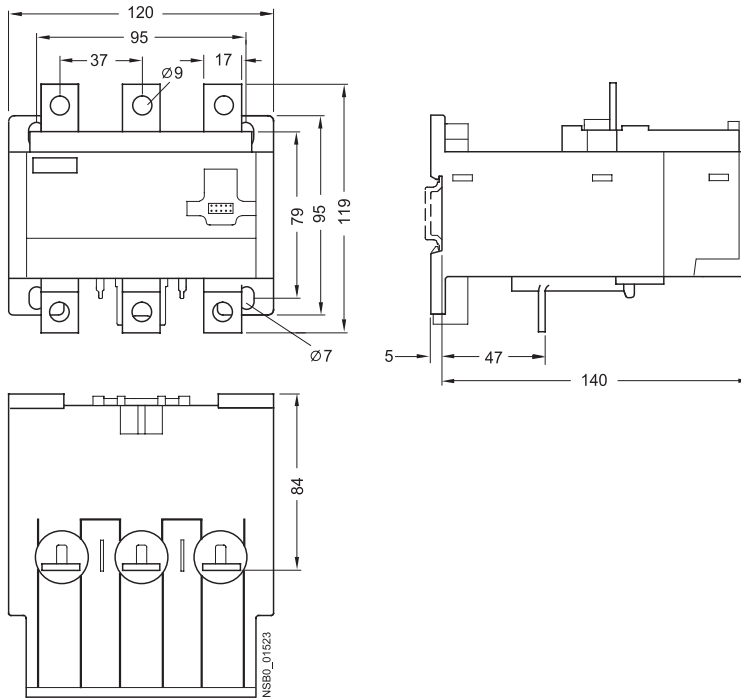

3RB29 56-2TH2 current measuring module

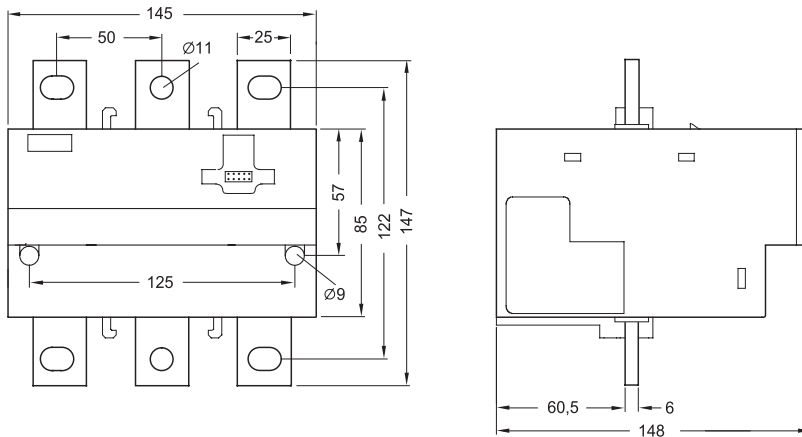

3RB29 66-2WH2 current measuring module

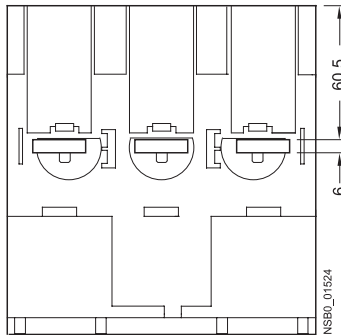

Overload Relays

3RB2 Solid-State Overload Relays

3RB22, 3RB23 for standard applications

Connections

Evaluation module	Function expansion module	Basic functions	Inputs		
			A1/A2	T1/T2	Y1/Y2
3RB22 83-4AA1 3RB22 83-4AC1 3RB23 83-4AA1 3RB23 83-4AC1	None	Inverse-time delayed protection, temperature-dependent protection, electrical remote RESET, overload warning	Power supply 24 ... 240 V AC/DC	Connection for PTC sensor	Electrical remote RESET
	3RB29 85-2CA1	Inverse-time delayed protection, temperature-dependent protection, internal ground-fault detection, electrical remote RESET, overload warning	Power supply 24 ... 240 V AC/DC	Connection for PTC sensor	Electrical remote RESET
	3RB29 85-2CB1	Inverse-time delayed protection, temperature-dependent protection, internal ground-fault detection, electrical remote RESET, ground fault signal	Power supply 24 ... 240 V AC/DC	Connection for PTC sensor	Electrical remote RESET
	3RB29 85-2AA0	Inverse-time delayed protection, temperature-dependent protection, electrical remote RESET, overload warning, analog output	Power supply 24 ... 240 V AC/DC	Connection for PTC sensor	Electrical remote RESET
	3RB29 85-2AA1	Inverse-time delayed protection, temperature-dependent protection, internal ground-fault detection, electrical remote RESET, overload warning, analog output	Power supply 24 ... 240 V AC/DC	Connection for PTC sensor	Electrical remote RESET
	3RB29 85-2AB1	Inverse-time delayed protection, temperature-dependent protection, internal ground-fault detection, electrical remote RESET, ground fault signal, analog output	Power supply 24 ... 240 V AC/DC	Connection for PTC sensor	Electrical remote RESET

Evaluation module	Function expansion module	Outputs				
		I (-) / I (+)	95/96 NC	97/98 NO	05/06 NC	07/08 NO
3RB22 83-4AA1 3RB22 83-4AC1 3RB23 83-4AA1 3RB23 83-4AC1	None	No	Switching off the contactor (inverse-time delayed/temperature-dependent protection)	Signal "tripped"	Overload warning	Overload warning
	3RB29 85-2CA1	No	Switching off the contactor (inverse-time delayed/temperature-dependent protection + ground fault)	Signal "tripped"	Overload warning	Overload warning
	3RB29 85-2CB1	No	Switching off the contactor (inverse-time delayed/temperature-dependent protection)	Signal "tripped"	Switching off the contactor (ground fault)	Signal "ground fault trip"
	3RB29 85-2AA0	Analog signal	Switching off the contactor (inverse-time delayed/temperature-dependent protection)	Signal "tripped"	Overload warning	Overload warning
	3RB29 85-2AA1	Analog signal	Switching off the contactor (inverse-time delayed/temperature-dependent protection + ground fault)	Signal "tripped"	Overload warning	Overload warning
	3RB29 85-2AB1	Analog signal	Switching off the contactor (inverse-time delayed/temperature-dependent protection)	Signal "tripped"	Switching off the contactor (ground fault)	Signal "ground fault trip"

Overview

Overload relays for standard applications

The following accessories are available for the 3RB2/3RB3 solid-state overload relays:



- One terminal bracket each for the overload relays size S00 and S0 (sizes S2 to S12 can be installed as single units without a terminal bracket)
- One mechanical RESET module for all sizes
- One cable release for resetting devices which are difficult to access (for all sizes)
- One sealable cover for all sizes
- Box terminal blocks for sizes S6 and S10/S12
- Terminal covers for sizes S2 to S10/S12

Overload relays for high-feature applications

The following accessories are available for the 3RB22/3RB23 solid-state overload relays:

- A sealable cover for the evaluation module
- Box terminal blocks for the current measuring modules size S6 and S10/S12
- Terminal covers for the current measuring modules size S6 and S10/S12
- Push-in lugs for screw mounting the size S00 to S3 current measuring modules

Selection and ordering data

Version	Size	Order No.	Weight per PU approx. kg	
Terminal brackets for stand-alone installation ^{1) 2)}				
 <p>3RU29.6-3AA01</p>	For separate mounting of the overload relay panel mount or snapped onto 35 mm standard mounting rail, size S3 also for 75 mm standard mounting rail	<i>Screw terminals</i> S00	3RU29 16-3AA01 0.04 3RU29 26-3AA01 0.05 3RU29 36-3AA01 0.18 3RU29 46-3AA01 0.28	
		<i>Spring Loaded terminals</i> S00	3RU29 16-3AC01 0.04 3RU29 26-3AC01 0.06	
		Resetting plungers, holders and formers	S00 to S3 S6 to S12	3RB39 80-0A 0.030 3RU19 00-1A 0.038
		Pushbuttons with extended stroke (12 mm), IP65, Ø 22 mm	S3 to S12	3SB30 00-0EA11 0.021
 <p>3RU19 00-1A with pushbutton and extension plunger</p>	Extension plungers For compensation of the distance between a pushbutton and the unlatching button of the relay	S3 to S12	3SX1 335 0.004	
	Complete mechanical reset assembly	S3 to S12	3SBES-RESET	
	Cable releases with holder for RESET ^{1) 2)}			
 <p>3RU19 00-1.</p>	For holes with Ø 6.5 mm in the mounting plate; max. control panel thickness 8 mm	• Length 400 mm S00 to S2	3RB39 80-0B 0.060	
		• Length 600 mm S00 to S2	3RB39 80-0C 0.073	
		• Length 400 mm S3 to S12	3RU19 00-1B 0.063	
		• Length 600 mm S3 to S12	3RU19 00-1C 0.073	







1) Accessories with a prefix of 3RB39 are intended for 3RB20/3RB30 overload relays only.

2) Only for 3RB20/3RB21. The accessories are identical to those of the 3RU1/3RU2 thermal overload relays.

Overload Relays

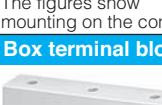
3RB2 Solid-State Overload Relays

Accessories

Version	Size	Order No.	List Price \$	Pack Units	Weight per PU approx. kg
Sealable covers					
 3RB3984-0	For covering the setting knobs				
	• For 3RB30/3RB31	S00 to S3	3RB39 84-0	10 units	0.003
	• For 3RB20/3RB21	S6 to S12	3RB29 84-0	10 units	0.020
	• For 3RB22 to 3RB24	–	3RB29 84-2	10 units	0.050
Terminal covers					
 3RT19 46-4EA1	Covers for cable lugs and rail connection				
	• Length 100 mm	S6	3RT19 56-4EA1		0.067
	• Length 120 mm	S10/S12	3RT19 66-4EA1		0.124
 3RT19 36-4EA2	Covers for box terminals				
	• Length 20.6 mm ¹⁾	S2	3RT29 36-4EA2		0.016
	• Length 20.8 mm ¹⁾	S3	3RT29 46-4EA2		0.023
	• Length 25 mm	S6	3RT19 56-4EA2		0.028
	• Length 30 mm	S10/S12	3RT19 66-4EA2		0.038
 3RT19 56-4EA2 The figures show mounting on the contactor	Covers for screw connections between contactor and overload relay, without box terminals (1 unit required per combination)	S6	3RT19 56-4EA3		0.021
		S10/S12	3RT19 66-4EA3		0.062
Box terminal blocks					
 3RT19 5.-4G	For round and ribbon cables up to 70 mm ² 2/0 AWG	S6 ²⁾	3RT19 55-4G		0.237
	up to 120mm ² 4/0 AWG	S6	3RT19 56-4G		0.270
	up to 240mm ² 500 mcm	S10/S12	3RT19 66-4G		0.676
	For conductor cross-sections, see LV 1 T "Technical Specifications"				
Push-in lugs					
 3RP19 03	For screw fixing of 3RB22/3RB23 overload relays	--	3RP19 03	10 units	0.002
	 3RB19 00-0B	For screw mounting of 3RB29 06 current measuring modules (2 units are required per module)	S00 ... S3	3RB29 00-0B	10 units

For more accessories (tools for spring-loaded terminals and labeling plates), see page 3/57.

1) Only for 3RB20/3RB21. The accessories are identical to those of the 3RU11 thermal overload relays.

2) In the scope of supply for 3RT10 54-1 contactors (55 kW).

Overview

Overload relays for standard applications

The following accessories are available for the 3RB20/3RB21 solid-state overload relays:

- One terminal bracket each for the overload relays size S00 and S0 (sizes S2 to S12 can be installed as stand-alone installation without a terminal bracket)
- One mechanical remote RESET module for all sizes
- One cable release for resetting devices which are difficult to access (for all sizes)
- One sealable cover for all sizes
- Box terminal blocks for sizes S6 and S10/S12
- Terminal covers for sizes S2 to S10/S12

Overload relays for High-Feature applications

The following accessories are available for the 3RB22/3RB23 solid-state overload relays:

- A sealable cover for the evaluation module
- Box terminal blocks for the current measuring modules size S6 and S10/S12
- Terminal covers for the current measuring modules size S6 and S10/S12

Technical specifications

Terminal brackets for stand-alone installation

Type	3RB29 13-0AA1	3RB29 23-0AA1
For overload relay	3RB20 16, 3RB21 13	3RB20 26, 3RB21 23
Size	S00	S0
Type of mounting	For screw and snap-on mounting onto TH35 standard mounting rail	
Connection for main circuit		
Connection type	Screw terminal	
Screw terminal		
• Terminal screw	Pozidriv size 2	
• Tightening torque	Nm 0.8 ... 1.2	2 ... 2.5
• Conductor cross-section (min./max.), 1 or 2 conductors		
- Solid	mm ² 1 × (0.5 ... 2.5), Max. 1 × (... 4)	1 × (1 ... 6), Max. 1 × (... 10)
- Finely stranded without end sleeve	mm ² --	--
- Finely stranded with end sleeve	mm ² 1 × (0.5 ... 2.5)	1 × (1 ... 6)
- Stranded	mm ² 1 × (0.5 ... 2.5), Max. 1 × (... 4)	1 × (1 ... 6), Max. 1 × (... 10)
- AWG conductors, solid or stranded	AWG 1 × (18 ... 14)	1 × (14 ... 10)

Overview

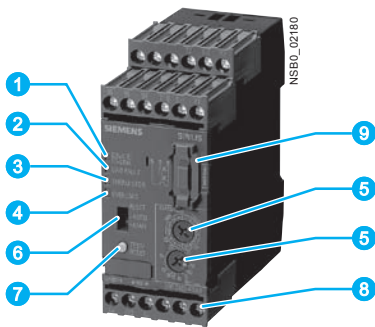

- 1 Green LED "DEVICE/IO-Link":
A continuous green light signals that the device is working correctly, a green flickering light signals the communication through IO-Link.
- 2 Red LED "GND FAULT":
A continuous red light signals an active ground-fault trip.
- 3 Red LED "THERMISTOR":
A continuous red light signals an active thermistor trip.
- 4 Red LED "OVERLOAD":
A continuous red light signals an active overload trip; a flickering red light signals an imminent trip (overload warning).
- 5 Motor current and trip class setting:
Setting the device to the motor current and to the required trip class dependent on the start-up conditions is easy with the two rotary switches.
- 6 Selector switch for manual/automatic RESET:
With this switch you can choose between manual and automatic RESET.
- 7 Test/RESET button:
Enables testing of all important device components and functions, plus resetting of the device after a trip when manual RESET is selected.
- 8 Connecting terminals (removable terminal block):
The generously sized terminals permit connection of two conductors with different cross-sections for the auxiliary, control and sensor circuits. Connection is possible with screw connection and alternatively with spring-type connection.
- 9 Plug-in point for operator panel:
enables connection of the 3RA69 35-0A operator panel.

SIRIUS 3RB24 evaluation module

The modular electronic overload relay 3RB24, which is powered via IO-Link (with monostable auxiliary contacts) up to 630 A (up to 820 A possible with a series transformer) have been designed for inverse-time delayed protection of loads with normal and heavy starting ("Function" see "Manual for SIRIUS 3RB24 Solid-State Overload Relay for IO-Link".) against excessive temperature rises due to overload, phase unbalance or phase failure. It comprises an evaluation unit, a current measuring module and a connecting cable. The evaluation module 3RB24 also offers an motor starter function: The contactors, which are connected via the auxiliary contacts, can also be actuated for operation via IO-Link. In this way, direct, reversing and star-delta starters up to 630 A (or 830 A) can be connected to the controller wirelessly via the IO-Link controller.

An overload, phase unbalance or phase failure result in an increase of the motor current beyond the set rated motor current.

This current rise is detected by means of the current measuring module (see page 3/55) and electronically evaluated by the evaluation module which is connected to it. The evaluation electronics sends a signal to the auxiliary contacts. The auxiliary contacts then switch off the load by means of a contactor. The

break time depends on the ratio between the tripping current and current setting I_e and is stored in the form of a long-term stable tripping characteristic (see www.siemens.com/sirius/support → "Characteristic Curves"). The "tripped" status is signaled by means of a continuously illuminated red "OVERLOAD" LED and also reported as a group fault via IO-Link.

The LED indicates imminent tripping of the relay due to overload, phase unbalance or phase failure by flickering when the limit current has been violated. This warning can also be reported to the higher-level PLC via IO-Link at the 3RB24 overload relay.

In addition to the described inverse-time delayed protection of loads against excessive temperature rises, the 3RB24 solid-state overload relays also allow direct temperature monitoring of the motor windings (full motor protection) by connection with broken-wire interlock of a PTC sensor circuit. With this temperature-dependent protection, the loads can be protected against overheating caused indirectly by reduced coolant flow, for example, which cannot be detected by means of the current alone. In the event of overheating, the devices switch off the contactor, and thus the load, by means of the auxiliary contacts. The "tripped" status is signaled by means of a continuously illuminated "THERMISTOR" LED and also reported as a group fault via IO-Link.

To the loads against incomplete ground faults due to damage to the insulation, humidity, condensation, etc., to protect the electronic overload relay 3RB24 offer the possibility of internal ground-fault detection (for details see "Manual for SIRIUS 3RB24 Solid-State Overload Relay for IO-Link", not possible in conjunction with contactor assembly for wye-delta starting). In the event of a ground fault, the 3RB24 relays trip instantaneously.

The "tripped" status is signaled by means of a flashing red LED "Ground Fault" and reported at the overload relay 3RB24 as a group fault via IO-Link.

The reset after overload, phase unbalance, phase failure, thermistor or ground-fault tripping is performed manually by key on site, via IO-Link or by electrical remote RESET or automatically after the cooling time (motor model) or for thermistor protection after sufficient cooling. Power cuts in devices due to function monitoring (broken wire or short circuit on the thermistor) can only be reset on-site ("Function" see "Manual for SIRIUS 3RB24 Solid-State Overload Relay for IO-Link"). In conjunction with a function expansion module, the motor current measured by the microprocessor can be output in the form of an analog signal DC 4 to 20 mA for operating rotary coil instruments or for feeding into analog inputs of programmable logic controllers.

The current values can be transmitted to the higher-level controller via IO-Link.

The devices are manufactured in accordance with environmental guidelines and contain environmentally friendly and reusable materials.

They comply with all important worldwide standards and approvals.

Type of protection "increased safety EEx e and explosion-proof enclosure EEx d" in accordance with ATEX Directive 94/9/EC

The electronic overload relay 3RB24 (monostable) are suitable for the overload protection of explosion-proof motors of types of protection EEx e and EEx d.

They comply with the requirements of EN 60079-7 (Electrical apparatus for areas subject to explosion hazards - Increased safety "e" as well as for flameproof enclosure "d"); see www.siemens.com/sirius/atex.

EC type test certificate for Group II, Category (2) G/D has been submitted. On request.

Order No. scheme

Digit of the Order No.	1st - 3rd	4th	5th	6th	7th	8th	9th	10th	11th			
Solid-state overload relays	□□□	□	□	□	□	-	□	□	□			
SIRIUS 2nd generation	3 R B											
Device series	2											
Size, rated operational current and power				□								
Version of the automatic RESET, electrical remote RESET				□								
Trip class (CLASS)						□						
Setting range of the overload release						□						
Connection methods								□				
Installation type								□				
Example	3	R	B	2	4	8	3	-	4	A	A	1

Note:

The Order No. scheme is presented here merely for information purposes and for better understanding of the logic behind the order numbers.

For your orders, please use the order numbers quoted in the catalog in the Selection and ordering data.

Benefits

The most important features and benefits of the 3RB24 solid-state overload relays for IO-Link are listed in the overview table (see "General Data", page 3/2 onwards).

Advantages through energy efficiency

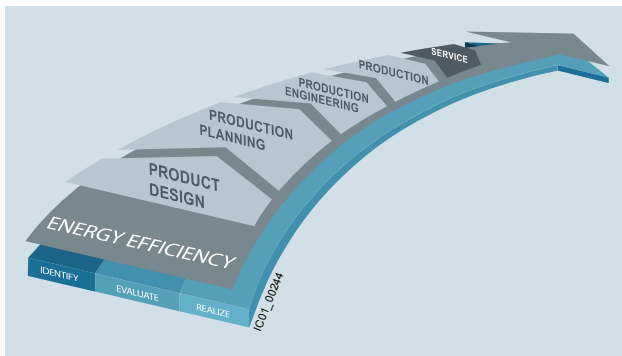

Overview of the energy management process

We offer you a unique portfolio for industrial energy management, using an energy management system that helps to optimally define your energy needs. We split up our industrial energy management into three phases – Identification, Evaluation and Realization – and we support you with the appropriate hardware and software solutions in every process phase.

The innovative products of the SIRIUS industrial controls portfolio can also make a substantial contribution to a plant's energy efficiency (see www.siemens.com/sirius/energysaving).

3RB24 solid-state overload relays for IO-Link contribute to energy efficiency throughout the plant as follows:

- Transmission of current values
- Reduced inherent power loss
- Less heating of the control cabinet
- Smaller control cabinet air conditioners can be used

Application

Industries

The 3RB24 solid-state overload relays are suitable for customers from all industries who want to guarantee optimum inverse-time delayed and temperature-dependent protection of their electrical loads (e.g. motors) under normal and heavy starting conditions (CLASS 5 to 30), minimize project completion times, inventories and energy consumption, and optimize plant availability and maintenance management.

Application

The 3RB24 solid-state overload relays have been designed for the protection of three-phase asynchronous and single-phase AC motors.

In addition to protection function, these devices can be used together with contactors as direct or reversing starters (star-delta (wye-delta) start also possible), which are controlled via IO-Link. This makes it possible to directly control drives via IO-Link from a higher-level controller or on site via the optional hand-held device lamps and also, for example, to return current values directly via IO-Link.

If single-phase AC motors are to be protected by the 3RB24 solid-state overload relays, the main current paths of the current measuring modules must be series-connected ("Schematics" see "Manual for SIRIUS 3RB24 Solid-State Overload Relay for IO-Link").

Ambient conditions

The devices are insensitive to external influences such as shocks, corrosive ambient conditions, ageing and temperature fluctuations.

For the temperature range from -25 °C to +60 °C, the 3RB24 solid-state overload relays compensate the temperature in accordance with IEC 60947-4-1.

Configuration notes for use of the devices below -25 °C or above +60 °C on request.

Overload Relays

3RB24 Solid-State Overload Relays

3RB24 for IO-Link, up to 630 A for High-Feature applications

Selection and ordering data

3RB24 solid-state overload relays (evaluation module) for full motor protection, stand-alone installation, CLASS 5, 10, 20 and 30, adjustable

Type	3RB24 83-4A.1
Features and technical specifications	
Overload protection, phase failure protection and unbalance protection	✓
Supplied from an external voltage	✓ 24 V DC through IO-Link
Direct-on-line or reversing starters (wye-delta starting also possible) controllable through IO-Link	✓
Auxiliary contacts	✓ 1 CO and 1 NO in series
Manual and automatic RESET	✓
Remote-RESET	✓ (electrically or via IO-Link)
4 LEDs for operating and status displays	✓
TEST function and self-monitoring	✓
Internal ground-fault detection	✓
Screw or spring-type terminals for auxiliary, control and sensor circuits	✓
Input for PTC sensor circuit	✓
Analog output	✓
IO-Link-specific functions	
• Connection of direct-on-line, reversing and star-delta starters to the controller via IO-Link	✓
• On-site controlling of the starter using the hand-held device	✓
• Accessing process data (e.g. current values in all three phases) via IO-Link	✓
• Accessing parameterization and diagnostics data (e.g. tripped signals) via IO-Link	✓

✓ Available



PU (UNIT, SET, M) = 1
 PS* = 1 unit
 PG = 41G



3RB24 83-4AA1



3RB24 83-4AC1

Size of contactor	Version	Screw terminals 		Spring-type terminals 	
		Order No.	Price per PU	Order No.	Price per PU
Evaluation modules					
S00 ... S12	Monostable	3RB24 83-4AA1		3RB24 83-4AC1	

Notes:

- Analog input modules, e.g. SM 331, must be configured for 4-wire measuring transducers. The analog input module may not supply current to the analog output of the 3RB24 relay.

Current measuring modules and related connecting cables [see page 3/55](#), accessories [see pages 3/56 and 3/57](#).





Overload Relays

3RB24 Solid-State Overload Relays

Current measuring modules for 3RB22, 3RB23, 3RB24

Selection and ordering data

Current measuring modules for mounting onto contactor¹⁾ and stand-alone installation¹⁾²⁾ (essential accessories)

Size con- tactor ³⁾	Rating for induction motor, ⁴⁾		Current set- ting of the inverse-time delayed overload release	Short-circuit pro- tection with fuse, type of coordina- tion "2", opera- tional class gG ⁵⁾	For over- load relays	DT	Order No.	Price per PU	PU (UNIT, SET, M)	Pack Units	PG
	kW	A									
Sizes S00/S0²⁾⁶⁾											
 3RB29 06-2.G1	S00/S0	0.09 ... 1.1	0.3 ... 3	20	3RB22 to 3RB24	▶	3RB29 06-2BG1		1	1 unit	41G
		1.1 ... 11	2.4 ... 25	63							
Sizes S2/S3²⁾⁶⁾											
 3RB29 06-2JG1	S2/S3	5.5 ... 45	10 ... 100	315	3RB22 to 3RB24	▶	3RB29 06-2JG1		1	1 unit	41G
Size S6¹⁾⁶⁾											
 3RB29 56-2TG2	S6 with busbar connection	11 ... 90	20 ... 200	315	3RB22 to 3RB24	▶	3RB29 56-2TH2		1	1 unit	41G
	For mount- ing to S6 contactors with box terminals				3RB22 to 3RB24	▶	3RB29 56-2TG2		1	1 unit	41G
Sizes S10/S12¹⁾											
 3RB29 66-2WH2	S10/S12 and size 14 (3TF68/ 3TF69)	37 ... 450	63 ... 630	800	3RB22 to 3RB24	▶	3RB29 66-2WH2		1	1 unit	41G

Note:

The connecting cable between the current measuring module and the evaluation module is not included in the scope of supply; please order separately.

1) The current measuring modules with an Order No. ending with "2" are designed for mounting onto contactor and stand-alone installation. For 3TF68/3TF69 contactors, direct mounting is not possible.

2) The current measuring modules with an Order No. ending with "1" are designed for stand-alone installation.

3) Observe maximum rated operational current of the devices.

4) Guide value for 4-pole standard motors at 50 Hz 400 V AC. The actual starting and rated data of the motor to be protected must be considered when selecting the units.

5) Maximum protection by fuse for overload relay, type of coordination "2".
"Fuse Values in Connection with Contactors" see
- "Configuration Manual for Configuring SIRIUS – Selection Data for Load Feeders in Fuseless and Fused Designs"
- "Configuration Manual for Configuring SIRIUS Innovations – Selection Data for Load Feeders in Fuseless and Fused Designs".

6) The modules with an Order No. with "G" in penultimate position are equipped with a straight-through transformer.

Accessories

Size of con- tactor	Version	For over- load relays	DT	Order No.	Price per PU	PU (UNIT, SET, M)	Pack Units	PG	
Connecting cables (necessary accessories)									
 3RB29 87-2.	S00 ... S3	For connection between evaluation module and current measuring module • Length 0.1 m (only for mounting of the evaluation module directly onto the current measuring module)	3RB24, 3RB29	▶	3RB29 87-2B		1	1 unit	41F
	S00 ... S12	• Length 0.5 m	3RB24, 3RB29	▶	3RB29 87-2D		1	1 unit	41F

Additional general accessories [see page 3/57](#).

Overload Relays

3RB24 Solid-State Overload Relays

Accessories for 3RB22, 3RB23, 3RB24

Overview

Overload relays for High-Feature applications

The following optional accessories are available for the 3RB22 to 3RB24 solid-state overload relays:

- Operator panel for the evaluation modules 3RB24
- Manual 3RB24
- Sealable cover for the evaluation modules 3RB22 to 3RB24
- Terminal covers for the 3RB29 current measuring modules sizes S6 and S10/S12
- Box terminal blocks for the 3RB29 current measuring modules sizes S6 and S10/S12
- Push-in lugs for screw fixing for 3RB22 to 3RB24 evaluation modules and 3RB29 06 current measuring modules

Selection and ordering data

Accessories for overload relay 3RB24

Version	For over-load relays	DT	Order No.	Price per PU	PU (UNIT, SET, M)	Pack Units	PG
Operator panels for evaluation modules							
 <p>3RA69 35-0A</p>	Operator panels (set)	3RB24	A	3RA69 35-0A	1	1 unit	42F
	1 set comprises: <ul style="list-style-type: none"> • 1 x operator panel • 1 x 3RA69 36-0A enabling module • 1 x 3RA69 33-0B interface cover • 1 x fixing terminal Note: The connecting cable between the evaluation module and the operator panel is not included in the scope of supply; please order separately.						
	Connecting cable	3RB24	▶	3UF79 33-0BA00-0	1	1 unit	42J
	Enabling modules (replacement)	3RB24	A	3RA69 36-0A	1	1 unit	42F
Interface covers	3RB24	A	3RA69 33-0B	1	5 units	42F	

¹⁾ The manual is also available as a free PDF download on the Internet at www.siemens.com/sirius/support → "Manuals/Operating Instructions".





Additional general accessories [see next page](#).

Overload Relays

3RB24 Solid-State Overload Relays

Accessories for 3RB22, 3RB23, 3RB24

General accessories

Version	Size	For over-load relays	Order No.	PU (UNIT, SET, M)	Pack Units
Sealable covers for evaluation modules					
	For covering the setting knobs	--	3RB22 to 3RB24	3RB29 84-2	1 10 units
Terminal covers for current measuring modules					
Covers for cable lugs and busbar connections					
	• Length 100 mm	S6	3RB29 56	3RT19 56-4EA1	1 1 unit
	• Length 120 mm	S10/S12	3RB29 66	3RT19 66-4EA1	1 1 unit
Covers for box terminals					
	• Length 25 mm	S6	3RB29 56	3RT19 56-4EA2	1 1 unit
	• Length 30 mm	S10/S12	3RB29 66	3RT19 66-4EA2	1 1 unit
Covers for screw terminals					
	between contactor and overload relay, without box terminals	S6	3RB29 56	3RT19 56-4EA3	1 1 unit
	(1 unit required per combination)	S10/S12	3RB29 66	3RT19 66-4EA3	1 1 unit
Box terminal blocks for current measuring modules					
	For round and ribbon cables				
	• Up to 70 mm ²	S6 ¹⁾	3RB29 56	3RT19 55-4G	1 1 unit
	• Up to 120 mm ²	S6	3RB29 56	3RT19 56-4G	1 1 unit
	• Up to 240 mm ²	S10/S12	3RB29 66	3RT19 66-4G	1 1 unit
Technical specifications for conductor cross-sections see "Reference Manual for Protection Equipment-3RU1, 3RB2 Overload Relays".					
Push-in lugs for evaluation modules and current measuring modules					
	For screw fixing the evaluation modules	--	3RB22 to 3RB24	3RP19 03	1 10 units
	For screw fixing the current measuring modules	S00 ... S3	3RB29 06	3RB19 00-0B	100 10 units
(2 units per module)					

3RB29 84-2

3RP19 03

3RB29 00-0B

¹⁾ In the scope of supply for 3RT10 54-1 contactors (55 kW).

Version	Size	Color	For over-load relays	Order No.	PU (UNIT, SET, M)	Pack Units
---------	------	-------	----------------------	-----------	-------------------	------------

Tools for opening spring-type terminals

	Screwdrivers For all SIRIUS devices with spring-type terminals	Length approx. 200 mm, 3.0 mm x 0.5 mm	Titanium gray/black, partially insulated	Main and auxiliary circuit connection: 3RB2	3RA29 08-1A	1 1 unit
---	--	---	--	---	--------------------	----------

3RA29 08-1A

Blank labels

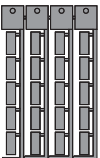
	Unit labeling plates¹⁾ for SIRIUS devices	20 mm x 7 mm	Titanium gray	3RB24	3RT29 00-1SB20	100 340 units
		20 mm x 7 mm	Pastel turquoise	3RB22, 3RB23	3RT29 00-1SB20	100 340 units

3RT19 00-1SB20

¹⁾ PC labeling system for individual inscription of unit labeling plates available from: murrplastik Systemtechnik GmbH (see "Appendix" → "External Partners").

Overload Relays

3RB24 Solid-State Overload Relays

3RB24 for IO-Link, up to 630 A for High-Feature applications



Type – Overload relay of evaluation modules			3RB24 83-4A.1
Size of contactor			S00 ... S10/S12
Dimensions of evaluation modules (W x H x D)			45 x 111 x 95
Auxiliary circuit			
Number of auxiliary switches		1 CO contact, 1 NO contact connected in series internally	
Auxiliary contacts – assignment		<ul style="list-style-type: none"> • 1 CO contact for selecting the contactor (for reversing starter function), actuated by the control system • 1 NO contact for normal switching duty, actuated by the control system (opens automatically when tripping occurs) 	
Rated insulation voltage U_i (pollution degree 3)	V	300	
Rated impulse withstand voltage U_{imp}	kV	4	
Auxiliary contacts – contact rating			
• NC contact with alternating current AC-14/AC-15, rated operational current I_e at U_e	A		
- 24 V	A	6	
- 120 V	A	6	
- 125 V	A	6	
- 250 V	A	3	
• NO contact with alternating current AC-14/AC-15, rated operational current I_e at U_e	A		
- 24 V	A	6	
- 120 V	A	6	
- 125 V	A	6	
- 250 V	A	3	
• NC contact, NO contact with direct current DC-13, rated operational current I_e at U_e	A		
- 24 V	A	2	
- 60 V	A	0.55	
- 110 V	A	0.3	
- 125 V	A	0.3	
- 250 V	A	0.2	
• Conventional thermal current I_{th}	A	5	
• Contact reliability (suitability for PLC control; 17 V, 5 mA)		Yes	
Short-circuit protection			
• With fuse, operational class gG	A	6	
• With miniature circuit breaker, C characteristic	A	1.6	
Protective separation between auxiliary conducting paths acc. to IEC 60947-1	V	300	
CSA, UL, UR rated data			
Auxiliary circuit – switching capacity		B300, R300	
Conductor cross-sections of the auxiliary circuit			
Connection type		Screw terminals	
Terminal screw		M3, Pozidriv size 2	
Operating devices	mm	3.0 x 0.5	
Prescribed tightening torque	Nm	0.8 ... 1.2	
Conductor cross-sections (min./max.), 1 or 2 conductors can be connected			
• Solid	mm ²	1 x (0.5 ... 4) ¹⁾ , 2 x (0.5 ... 2.5) ¹⁾	
• Finely stranded without end sleeve	mm ²	--	
• Finely stranded with end sleeve	mm ²	1 x (0.5 ... 2.5) ¹⁾ , 2 x (0.5 ... 1.5) ¹⁾	
• Stranded	mm ²	--	
• AWG cables, solid or stranded	AWG	2 x (20 ... 14)	
Connection type		Spring-type terminals	
Operating devices	mm	3.0 x 0.5	
Conductor cross-sections (min./max.), 1 or 2 conductors can be connected			
• Solid	mm ²	2 x (0.25 ... 1.5)	
• Finely stranded without end sleeve	mm ²	--	
• Finely stranded with end sleeve	mm ²	2 x (0.25 ... 1.5)	
• AWG cables, solid or stranded	AWG	2 x (24 ... 16)	

1) If two different conductor cross-sections are connected to one clamping point, both cross-sections must be in the range specified

Overload Relays

3RB24 Solid-State Overload Relays

3RB24 for IO-Link, up to 630 A for High-Feature applications

Type – Overload relay of evaluation modules		3RB24 83-4A.1
Size of contactor		S00 ... S10/S12
Control and sensor circuit as well as the analog output		
Rated insulation voltage U_i (pollution degree 3)	V	300
Rated impulse withstand voltage U_{imp}	kV	4
Rated control supply voltage U_s		
• DC	V	24 through IO-Link
Operating range		
• DC		$0.85 \times U_{s\ min} \leq U_s \leq 1.1 \times U_{s\ max}$
Rated power		
• DC	W	0.5
Mains buffering time	ms	200
Thermistor motor protection (PTC thermistor detector)		
• Summation cold resistance	k Ω	≤ 1.5
• Response value	k Ω	3.4 ... 3.8
• Return value	k Ω	1.5 ... 1.65
Ground-fault detection		
• Tripping value I_A		The information refers to sinusoidal residual currents at 50/60 Hz.
- For $0.3 \times I_e < I_{motor} < 2.0 \times I_e$		$> 0.3 \times I_e$
- For $2.0 \times I_e < I_{motor} < 8.0 \times I_e$		$> 0.15 \times I_{motor}$
• Response time t_{trip}	ms	500 ... 1 000
Analog output¹⁾		
• Output signal	mA	4 ... 20
• Measuring range		0 ... $1.25 \times I_e$ 4 mA corresponds to $0 \times I_e$ 16.8 mA corresponds to $1.0 \times I_e$ 20 mA corresponds to $1.25 \times I_e$
• Load, max.	Ω	100
Conductor cross-sections for the control and sensor circuit as well as the analog output		
Connection type		 Screw terminals
Terminal screw		M3, Pozidriv size 2
Operating devices	mm	3.0 x 0.5
Prescribed tightening torque	Nm	0.8 ... 1.2
Conductor cross-sections (min./max.), 1 or 2 conductors can be connected		
• Solid	mm ²	$1 \times (0.5 \dots 4)^2, 2 \times (0.5 \dots 2.5)^2$
• Finely stranded without end sleeve	mm ²	—
• Finely stranded with end sleeve	mm ²	$1 \times (0.5 \dots 2.5)^2, 2 \times (0.5 \dots 1.5)^2$
• Stranded	mm ²	—
• AWG cables, solid or stranded	AWG	$2 \times (20 \dots 14)$
Connection type		 Spring-type terminals
Operating devices	mm	3.0 x 0.5
Conductor cross-sections (min./max.), 1 or 2 conductors can be connected		
• Solid	mm ²	$2 \times (0.25 \dots 1.5)$
• Finely stranded without end sleeve	mm ²	—
• Finely stranded with end sleeve	mm ²	$2 \times (0.25 \dots 1.5)$
• Stranded	mm ²	$2 \times (0.25 \dots 1.5)$
• AWG cables, solid or stranded	AWG	$2 \times (24 \dots 16)$

1) Analog input modules, e.g. SM 331, must be configured for 4-wire measuring transducers. The analog input module may not supply current to the analog output of the 3RB24 overload relay.

2) If two different conductor cross-sections are connected to one clamping point, both cross-sections must be in the range specified.

Overload Relays

3RB24 Solid-State Overload Relays

Current measuring modules for 3RB22, 3RB23, 3RB24

Overview



SIRIUS 3RB29 06 current measuring module

The current measuring modules are designed as system components for connecting to evaluation units 3RB22 to 3RB24. Using these evaluation units the motor current is measured and the measured value sent to the evaluation unit for evaluation. The current measuring modules in sizes S00 to S3 up to 55 mm wide are equipped with straight-through transformers and can be snap-fitted under the evaluation units. The larger evaluation units are installed directly on the contactor or as stand-alone units.

Technical specifications

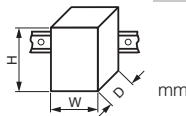
Type – Overload relays: Current measuring modules		3RB29 06		3RB29 56		3RB29 66	
Size of contactor		S00/S0	S2/S3	S6			S10/S12
Dimensions of current measuring modules (W x H x D)		45 x 84 x 45	55 x 94 x 72	120 x 119 x 145			145 x 147 x 148
Main circuit							
Rated insulation voltage U_i (pollution degree 3)	V	1 000					
Rated impulse withstand voltage U_{imp}	kV	6		8			
Rated operational voltage U_e	V	1 000					
Type of current		No Yes, 50/60 Hz $\pm 5\%$					
• Direct current		No					
• Alternating current		Yes, 50/60 Hz $\pm 5\%$					
Current setting	A	0.3 ... 3; 2.4 ... 25	10 ... 100	20 ... 200	63 ... 630		
Power loss per unit (max.)	W	0.5					
Short-circuit protection		See "Selection and ordering data" on page 3/55. See - "Configuration Manual for Configuring SIRIUS – Selection Data for Load Feeders in Fuseless and Fused Designs" - "Configuration Manual for Configuring SIRIUS Innovations – Selection Data for Load Feeders in Fuseless and Fused Designs"					
Protective separation between main and auxiliary conducting paths V acc. to IEC 60947-1 (pollution degree 2)		690 for grounded networks, otherwise 600					

Overload Relays

3RB24 Solid-State Overload Relays

Current measuring modules for 3RB22, 3RB23, 3RB24

Type – Overload relays: Current measuring modules

Size of contactor

Dimensions of current measuring modules (W x H x D)

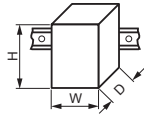

Conductor cross-sections of the main circuit

Connection type

⊕ Screw terminals with box terminal

		3RB29 06		3RB29 56	3RB29 66
		S00/S0	S2/S3	S6	S10/S12
		45 x 84 x 45	55 x 94 x 72	120 x 119 x 145	145 x 147 x 148
		mm			
		⊕ Screw terminals with box terminal			
Terminal screw	mm	—	—	4 mm Allen screw	5 mm Allen screw
Operating devices	mm	—	—	4 mm Allen screw	5 mm Allen screw
Prescribed tightening torque	Nm	—	—	10 ... 12	20 ... 22
Conductor cross-sections (min./max.), 1 or 2 conductors can be connected					
• Solid	mm ²	—	—	—	—
• Finely stranded without end sleeve	mm ²	—	—	With 3RT19 55-4G box terminal: 2 × (1 × max. 50, 1 × max. 70), 1 × (10 ... 70)	2 × (50 ... 185), rear clamping point only: 1 × (70 ... 240)
				With 3RT19 56-4G box terminal: 2 × (1 × max. 95, 1 × max. 120), 1 × (10 ... 120)	Rear clamping point only: 1 × (120 ... 185)
• Finely stranded with end sleeve	mm ²	—	—	With 3RT19 55-4G box terminal: 2 × (1 × max. 50, 1 × max. 70), 1 × (10 ... 70)	2 × (50 ... 185), rear clamping point only: 1 × (70 ... 240)
				With 3RT19 56-4G box terminal: 2 × (1 × max. 95, 1 × max. 120), 1 × (10 ... 120)	Rear clamping point only: 1 × (120 ... 185)
• Stranded	mm ²	—	—	With 3RT19 55-4G box terminal: 2 × (max. 70), 1 × (16 ... 70)	2 × (70 ... 240), rear clamping point only: 1 × (95 ... 300)
				With 3RT19 56-4G box terminal: 2 × (max. 120), 1 × (16 ... 120)	Rear clamping point only: 1 × (120 ... 240)
• AWG cables, solid or stranded	AWG	—	—	With 3RT19 55-4G box terminal: 2 × (max. 1/0), 1 × (6 ... 2/0)	2 × (2/0 ... 500 kcmil), rear clamping point only: 1 × (3/0 ... 600 kcmil)
				With 3RT19 56-4G box terminal: 2 × (max. 3/0), 1 × (6 ... 250 kcmil)	Rear clamping point only: 1 × (250 kcmil ... 500 kcmil)
• Ribbon cables (number x width x thickness)	mm	—	—	With 3RT19 55-4G box terminal: 2 × (6 × 15.5 × 0.8), 1 × (3 × 9 × 0.8 ... 6 × 15.5 × 0.8)	2 × (20 × 24 × 0.5), 1 × (6 × 9 × 0.8 ... 20 × 24 × 0.5)
				With 3RT19 56-4G box terminal: 2 × (10 × 15.5 × 0.8), 1 × (3 × 9 × 0.8 ... 10 × 15.5 × 0.8)	
Connection type		Busbar connections			
Terminal screw	mm	—	—	M8 × 25	M10 × 30
Prescribed tightening torque	Nm	—	—	10 ... 14	14 ... 24
Conductor cross-sections (min./max.), 1 or 2 conductors can be connected					
• Solid with cable lug	mm ²	—	—	16 ... 95 ¹⁾	50 ... 240 ²⁾
• Stranded with cable lug	mm ²	—	—	25 ... 120 ¹⁾	70 ... 240 ²⁾
• AWG cable, solid or stranded, with cable lug	AWG	—	—	4 ... 250 kcmil	2/0 ... 500 kcmil
• with connecting bar (max. width)	mm	—	—	17	25
Connection type		Straight-through transformers			
Diameter of opening	mm	7.5	14	25	—

¹⁾ When connecting cable lugs according to DIN 46235 with conductor cross-sections of 95 mm² and more, the 3RT19 56-4EA1 terminal cover must be used to ensure phase spacing.

²⁾ When connecting cable lugs according to DIN 46234 with conductor cross-sections of 240 mm² and more as well as to DIN 46235 with conductor cross-sections of 185 mm² and more, the 3RT19 56-4EA1 terminal cover must be used for to keep the phase clearance.

SIMOCODE pro 3UF7

General data

Overview

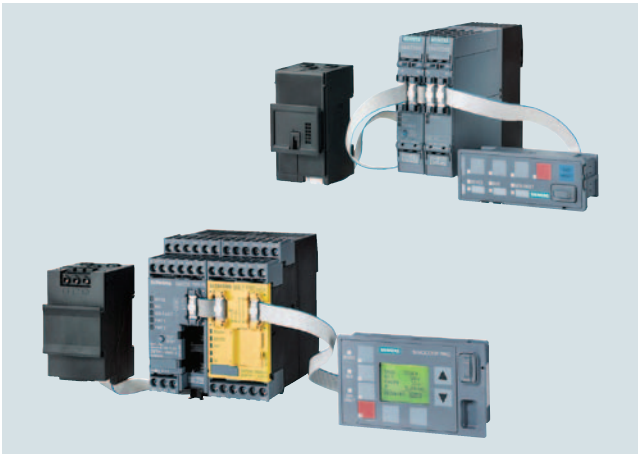

SIMOCODE pro S and SIMOCODE pro V

More information

- Home page, see www.usa.siemens.com/simocode
- Industry Mall, see www.siemens.com/product?3UF7
- TIA Selection Tool Cloud (TST Cloud)
 - For SIMOCODE pro S, see <https://mall.industry.siemens.com/spice/TSTWeb/?kmat=SimocodeProS>
 - For SIMOCODE pro V, see <https://mall.industry.siemens.com/spice/TSTWeb/?kmat=SimocodeProV>

SIMOCODE pro is a flexible, modular motor management system for motors with constant speeds in the low-voltage performance range. It optimizes the connection between I&C and motor feeder, increases plant availability and allows significant savings to be made for installation, commissioning, operation and maintenance of a system.

SIMOCODE pro offers, for example:

- Multifunctional, solid-state full motor protection that is independent of the automation system
- Integrated control functions instead of hardware for the motor control
- Detailed operational, service and diagnostics data
- Open communication via PROFIBUS, PROFINET/PROFIsafe, Modbus RTU, and Ethernet IP and OPC UA – which also lets you take advantage of the cloud
- Safety relay function for the fail-safe disconnection of motors up to SIL 3 (IEC 61508, IEC 62061) or PL e with Category 4 (EN ISO 13849-1)
- SIMOCODE ES (TIA Portal) is the software package for SIMOCODE pro parameterization, start up and diagnostics.

Device series

Basic Performance with SIMOCODE pro C

The compact system for direct-on-line starters and reversing starters or for controlling a motor starter protector.

General Performance with SIMOCODE pro S or SIMOCODE pro V PN GP

The smart system for direct-on-line, reversing, and wye-delta starters or for controlling a motor starter protector or soft starter. Its expandability with an expansion module/multifunction module provides comprehensive input/output project data volume, precise ground-fault detection via the 3UL23 residual-current transformers and temperature measurement.

High Performance with SIMOCODE pro V

The variable system with all control functions and with the possibility of expanding the inputs, outputs and functions of the system at will using expansion modules

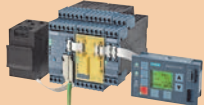
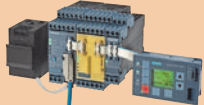
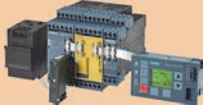
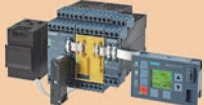
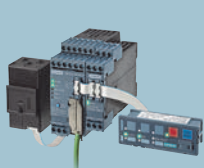
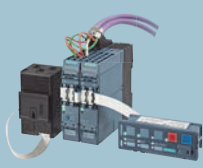
	PROFINET IO / OPC UA	ETHERNET / IP	PROFIBUS	MODBUS RTU	
Current/voltage measuring module	 SIMOCODE pro V PN	 SIMOCODE pro V EIP	 SIMOCODE pro V PB	 SIMOCODE pro V MR	High Performance
Operator panel with display					
Max. 5/7 expansion modules					
Safety					
Extended control functions (e.g. positioner, pole-changing starter)					
Current measuring module	 SIMOCODE pro V PN GP	 SIMOCODE pro S			General Performance
Operator panel					
1 expansion module					
Basic control functions (e.g. direct-on-line/reversing start)					

Device series

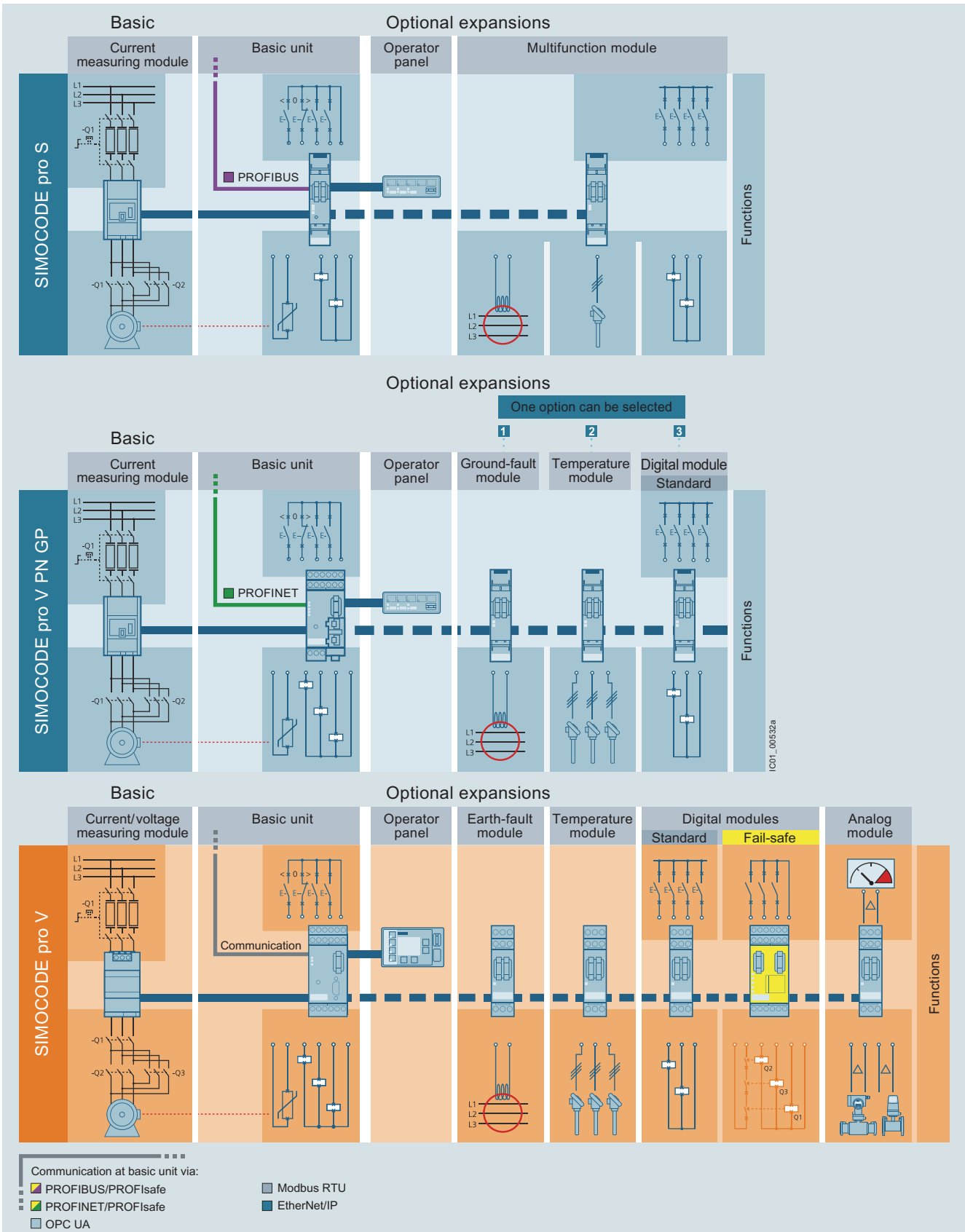

System structure

General data

Expansion possibilities	SIMOCODE pro C	SIMOCODE pro S	SIMOCODE pro V	SIMOCODE pro V	
	Basic Performance PROFIBUS	General Performance PROFIBUS	General Performance PROFINET GP	High Performance PROFIBUS/Modbus RTU	PROFINET/ EtherNet/IP
Operator panels	✓	✓	✓	✓	✓
Operator panels with display	--	--	--	✓	✓
Current measuring modules	✓	✓	✓	✓	✓
Current/voltage measuring modules	--	--	--	✓	✓
Expansion modules:					
• Digital modules	--	--	1 ²⁾	2	2
• Fail-safe digital modules ¹⁾	--	--	--	1	1
• Analog modules	--	--	--	1	2
• Ground-fault modules	--	--	1	1	1
• Temperature modules	--	--	1	1	2
• Multifunction modules	--	1	--	--	--

✓ Available
-- Not available

1) The fail-safe digital module can be used instead of one of the two digital modules.
2) Only monostable version can be used.

Per feeder each system always comprises one basic unit and one current measuring module. The two modules are connected together electrically through the system interface with a connection cable and can be mounted mechanically connected (one behind the other) or separately (side by side). The motor current to be monitored determines the size of the current measuring module.

An operator panel for mounting in the control cabinet door is optionally connectable through a second system interface on the basic unit. Both the current measuring module and the operator panel are electrically supplied by the basic unit through the connection cable. More inputs, outputs and functions can be

added to the SIMOCODE pro V and SIMOCODE pro S by means of optional expansion modules, thus supplementing the inputs and outputs already existing on the basic unit. With the DM-F Local and DM-F PROFIsafe fail-safe digital modules it is also possible to integrate the fail-safe disconnection of motors in the SIMOCODE pro V motor management system.

All modules are connected by connection cables. The connection cables are available in various lengths. The maximum distance between modules (e.g. between the basic unit and the current measuring module) must not exceed 2.5 m. The total length of all the connection cables per system interface of the basic unit may be up to 3 m.

Article No. scheme

Product versions	Article number
SIMOCODE pro motor management system	3UF7 □ □ □ - 1 □ □ 0 □ - 0
Type of unit/module	e.g. 0 = basic unit □
Functional version of the module	e.g. 20 = SIMOCODE pro S □ □
Connection type of the current transformer	e.g. A = through-hole technology □
Voltage version	e.g. B = 24 V DC □
Enclosure color	e.g. 1 = titanium gray □
Example	3UF7 0 2 0 - 1 A B 0 1 - 0

Note:

The Article No. scheme shows an overview of product versions for better understanding of the logic behind the article numbers.

For your orders, please use the article numbers quoted in the selection and ordering data.

Benefits

General customer benefits

- Integrating the whole motor feeder into the process control by means of PROFIBUS DP, PROFINET/OPC UA, Modbus RTU or EtherNet/IP significantly reduces the wiring between the motor feeder and the PLC
- Decentralization of the automated processes by means of configurable control and monitoring functions in the feeder saves resources in the automation system and ensures full functionality and protection of the feeder even if the I&C or bus system fails
- The acquisition and monitoring of operating, service and diagnostics data in the feeder and process control system increases plant availability as well as maintenance and service-friendliness
- The high degree of modularity allows users to perfectly implement their plant-specific requirements for each motor feeder
- The SIMOCODE pro system offers functionally graded and space-saving solutions for each customer application
- The replacement of the control circuit hardware with integrated control functions decreases the number of hardware components and wiring required and in this way limits stock keeping costs and potential wiring errors
- The use of electronic full motor protection permits better utilization of the motors and ensures long-term stability of the tripping characteristic and reliable tripping even after years of service
- Thanks to the precision of the current, voltage, power and energy measurements, costs can be internally allocated with a high degree of accuracy
- By virtue of its wide frequency range (20 to 400 Hz), SIMOCODE can be used in combination with the 2nd-generation current/voltage measuring modules in a wide range of motor applications.

Multifunctional, electronic full motor protection for rated motor currents up to 820 A

SIMOCODE pro offers comprehensive protection of the motor feeder by means of a combination of different, multi-step and delayable protection and monitoring functions:

- Inverse-time delayed electronic overload protection (CLASS 5E to 40E)
- Thermistor motor protection
- Phase failure/unbalance protection
- Stall protection
- Monitoring of adjustable limit values for the motor current
- Voltage and power monitoring
- Monitoring of the power factor (motor idling/load shedding)
- Ground-fault monitoring
- Temperature monitoring, e.g. via Pt100/Pt1000
- Monitoring of operating hours, downtime and number of starts etc.

Recording of measuring curves

SIMOCODE pro can record measuring curves and therefore is able, for example, to present the progression of motor current during motor start up.

Flexible motor control implemented with integrated control functions (instead of comprehensive hardware interlocks)

Many predefined motor control functions have already been integrated into SIMOCODE pro, including all necessary logic operations and interlocks:

- Overload relays
- Direct-on-line and reversing starters
- Wye/delta starters (also with direction reversal)
- Two speeds, motors with separate windings (pole-changing starter); also with direction reversal
- Two speeds, motors with separate Dahlander windings (also with direction reversal)
- Positioner actuation
- Solenoid valve actuation
- Actuation of a motor starter protector
- Soft starter actuation (also with direction reversal)

These control functions are predefined in SIMOCODE pro and can be freely assigned to the inputs and outputs of the device (including the PROFIBUS/PROFINET process image).

These predefined control functions can also be flexibly adapted to each customized configuration of a motor feeder by means of freely configurable logic modules (truth tables, counters, timers, edge evaluation, etc.) and with the help of standard functions (power failure monitoring, emergency start, external faults, etc.), without additional auxiliary relays being necessary in the control circuit.

SIMOCODE pro makes a lot of additional hardware and wiring in the control circuit unnecessary, which results in a high level of standardization of the motor feeder in terms of its design and circuit diagrams.

General data

Detailed operational, service and diagnostics data

SIMOCODE pro makes different operational, service and diagnostics data available and helps to detect potential faults in time and to prevent them by means of preventative measures. In the event of a malfunction, a fault can be diagnosed, localized and rectified very quickly – there are no or very short downtimes.

Operating data

- Motor switching state derived from the current flow in the main circuit
- All phase currents
- All phase voltages and phase-to-phase voltages
- Active power, apparent power and power factor
- Phase unbalance and phase sequence
- Ground-fault current
- Frequency
- Time to trip
- Motor temperature
- Remaining cooling time etc.

Service data

- Motor operating hours
- Motor stop times
- Number of motor starts
- Number of overload trips
- Interval for compulsory testing of the enabling circuits
- Energy consumed
- Internal comments stored in the device etc.

Diagnostics data

- Numerous detailed early warning and fault messages
- Internal device fault logging with time stamp
- Time stamping of freely selectable status, alarm or fault messages etc.

Easy operation and diagnosticsOperator panel

The operator panel is used to control the motor feeder and can replace all conventional pushbuttons and indicator lights to save space. It makes SIMOCODE pro or the feeder directly operable in the control cabinet. It features all the status LEDs available on the basic unit and externalizes the system interface for simple parameterization or diagnosis on a PC/PG.

Operator panel with display

As an alternative to the 3UF720 standard operator panel for SIMOCODE pro V, a 3UF721 operator panel with display is also available. This can additionally indicate current measured values, operational and diagnostics data or status information of the motor feeder at the control cabinet. The pushbuttons of the operator panel can be used to control the motor. Furthermore, it is possible to set parameters such as rated motor current, limit values, etc. directly via the operator panel with display (with SIMOCODE pro V PROFIBUS as of E15, SIMOCODE pro V Modbus RTU as of E03 and with all SIMOCODE pro V PROFINET and EtherNet/IP).

Communication

SIMOCODE pro V has either an integrated PROFIBUS DP or Modbus RTU interface (SUB-D or terminal connection) or a PROFINET or EtherNet/IP interface (2 x RJ45).

Fail-safe disconnection through PROFIBUS or PROFINET with the PROFIsafe profile is also possible in conjunction with a fail-safe controller (F-CPU) and the DM-F PROFIsafe fail-safe digital module.

SIMOCODE pro PROFIBUS

SIMOCODE pro PROFIBUS supports, for example:

- Cyclic services (DPV0) and acyclic services (DPV1)
- Extensive diagnostics and hardware interrupts
- Time stamp with high timing precision (SIMATIC S7) for SIMOCODE pro V
- DPV1 communication after the Y-Link

SIMOCODE pro PROFINET

SIMOCODE pro PROFINET supports, for example:

- Line and ring bus topology (for 2-port devices with an integrated switch)
- Media redundancy via MRP protocol (for 2-port devices with an integrated switch)
- Operating, service and diagnostics data via standard web browser
- OPC UA server for open communication with visualization and control system
- NTP-synchronized time
- Interval function and measured values for power management via PROFenergy
- Module exchange without PC/memory module through proximity detection
- Extensive diagnostics and maintenance alarms

System redundancy with SIMOCODE pro PROFINET

All SIMOCODE PROFINET devices support the system redundancy mechanisms of PROFINET IO and therefore can be operated directly on fault-tolerant systems such as SIMATIC S7-400 H. As such, SIMOCODE pro can provide decisive added value also for the field level of plants in which plant availability and control system redundancy are priorities.

SIMOCODE pro Modbus RTU

SIMOCODE pro Modbus RTU supports, for example:

- Communication at 1 200/2 400/4 800/9 600/19 200 or 57 600 baud
- Access to freely parameterizable process image via Modbus RTU
- Access to all operating, service and diagnostics data via Modbus RTU

SIMOCODE pro EtherNet/IP

SIMOCODE pro EtherNet/IP supports, for example:

- Line and ring bus topology thanks to an integrated switch
- Ring structures via Device Level Ring (DLR) protocol
- Operating, service and diagnostics data via standard web browser
- NTP-synchronized time
- Parameter assignment via SIMOCODE ES V14 or higher – via local device interface and Ethernet

General data

Notes on security

In order to protect plants, systems, machines and networks against cyber threats, it is necessary to implement – and continuously maintain – a holistic, state-of-the-art industrial security concept. Siemens products and solutions represent only one component of such a concept.

For more information on Industrial Security, see www.siemens.com/industrialsecurity.

Autonomous operation

An essential feature of SIMOCODE pro is the autonomous execution of all protection and control functions, even when communication to the I&C system is interrupted. This means that even in the event of bus system or automation system failure, full functionality of the feeder is ensured or a specific behavior can be parameterized in case of such a fault, e.g. targeted shutdown of the feeder or execution of particular parameterized control mechanisms (such as reversal of the direction of rotation).

Advantages from integrated energy management

siemens.com/energysuite

Ready for
SIMATIC
Energy Suite

As an integrated option for the TIA Portal, the SIMATIC Energy Suite couples energy management with automation efficiently, making energy consumption at your production facility transparent.

Thanks to the simplified configuration of energy-measuring components, e.g. SIMOCODE pro V, configuration effort is also clearly reduced.

Thanks to end-to-end connection with higher-level energy management systems or cloud-based services, you can seamlessly expand the recorded energy data to create a cross-site energy management system.

The advantages at a glance:

- Automatic generation of energy management data
- Integration into TIA Portal and into automation
- Simple configuration

For more information, see www.siemens.com/energysuite.

Application

SIMOCODE pro is often used for automated processes where plant downtimes are very expensive (e.g. chemical, oil/gas, water/wastewater, steel or cement industries) and where it is important to prevent plant downtimes through detailed operational, service and diagnostics data or to localize faults very quickly when they occur.

SIMOCODE pro is modular and space-saving and suited especially for operation in motor control centers (MCCs) in the process industry and for power plant technology.

Applications

- Protection and control of motors in hazardous areas for types of protection EEx e/d according to ATEX directive 2014/34/EU
 - With heavy starting (paper, cement, metal and water industries)
 - In high-availability plants (chemical, oil, raw material processing industries, power plants)
- New: Dry-running protection of centrifugal pumps based on active power monitoring for type of protection Ex b

Use of SIMOCODE pro 3UF7 with IE3/IE4 motorsNote:

When using the SIMOCODE pro 3UF7 in conjunction with highly energy-efficient IE3/IE4 motors, please observe the information on dimensioning and configuring, see [Application Manual](#).

Safety technology for SIMOCODE pro

The safe disconnection of motors in the process industry is becoming increasingly important as the result of new and revised standards and requirements in the safety technology field.

With the DM-F Local and DM-F PROFIsafe fail-safe expansion modules it is easy to integrate functions for fail-safe disconnection in the SIMOCODE pro V motor management system while retaining service-proven concepts. The strict separation of safety functions and operational functions proves particularly advantageous for planning, configuring and construction. Seamless integration in the motor management system leads to greater transparency for diagnostics and during operation of the system.

Suitable components for this purpose are the DM-F Local and DM-F PROFIsafe fail-safe expansion modules, depending on the requirements:

- The DM-F Local fail-safe digital module for when direct assignment between a fail-safe hardware shutdown signal and a motor feeder is required, or
- The DM-F PROFIsafe fail-safe digital module for when a fail-safe controller (F-CPU) creates the signal for disconnection and transmits it in a fail-safe manner through PROFIBUS/PROFIsafe or PROFINET/PROFIsafe to the motor management system

New: Dry-running protection of centrifugal pumps with SIMOCODE pro in hazardous areas

With special versions of the current/voltage measuring modules, SIMOCODE pro enables dry-running protection of centrifugal pumps through active power monitoring and motor switch-off. This applies to centrifugal pumps with progressive flow characteristics, which are also suitable for pumping flammable media and are also installed in hazardous areas. If the active power, and thus the flow rate, falls below a minimum value, the motor – and thus the centrifugal pump – is switched off. When determining the limit values to be monitored, the user is supported by a menu-guided teach-in process in the engineering software.

Technical specifications

More information

Technical specifications, see <https://support.industry.siemens.com/cs/ww/en/ps/16337/td>
 Manual Collection "SIMOCODE pro", see <https://support.industry.siemens.com/cs/ww/en/view/109743951>
 System Manual "SIMOCODE pro Safety Fail-Safe Digital Modules", see <https://support.industry.siemens.com/cs/ww/en/view/50564852>

Application Manual "SIRIUS Controls with IE3/IE4 motors", see <https://support.industry.siemens.com/cs/ww/en/view/94770820>
 Configuration Manual "Load Feeders – SIRIUS Modular System", see <https://support.industry.siemens.com/cs/ww/en/view/39714188>

General data

Type	3UF7	
Permissible ambient temperature		
• During operation	°C	-25 ... +60; 3UF721: 0 ... +60
• During storage and transport	°C	-40 ... +80; 3UF721: -20 ... +70
Degree of protection (acc. to IEC 60529)		
• Measurement modules with busbar connection		IP00
• Operator panel (front) and door adapter (front) with cover		IP54
• Other components		IP20
Shock resistance (sine pulse)	g/ms	15/11
Mounting position		Any
Frequency	Hz	50/60 ± 5%
EMC interference immunity (according to IEC 60947-1)		Corresponds to degree of severity 3
• Conducted interference, burst acc. to IEC 61000-4-4	kV	2 (power ports)
	kV	1 (signal port)
	V	10
• Conducted interference, high frequency acc. to IEC 61000-4-6		
• Conducted interference, surge acc. to IEC 61000-4-5	kV	2 (line to ground); 3UF7320-1AB, 3UF7330-1AB: 1 (line to ground)
	kV	1 (line to line); 3UF7320-1AB, 3UF7330-1AB: 0.5 (line to line)
• Electrostatic discharge, ESD acc. to IEC 61000-4-2	kV	8 (air discharge); 3UF7020: Operator input during operation only on the front
	kV	6 (contact discharge); 3UF721: 4 (contact discharge)
• Field-related interference acc. to IEC 61000-4-3	V/m	10
EMC emitted interference (according to IEC 60947-1)		
• Conducted and radiated interference emission		EN 55011/EN 55022 (CISPR 11/CISPR 22) (corresponds to degree of severity A)
Protective separation (acc. to IEC 60947-1)		All circuits in SIMOCODE pro are safely separated from each other according to IEC 60947-1, i.e. they are designed with doubled creepage paths and clearances. In this context, compliance with the instructions in the test report "Safe Isolation" No. 2668 is required.

Basic units						
Type		3UF7000-1AU00-0, 3UF7010-1AU00-0, 3UF7000-1AB00-0, 3UF7010-1AB00-0, 3UF7011-1AU00-0, 3UF7020-1AU01-0, 3UF7011-1AB00-0, 3UF7020-0AB01-0, 3UF7012-1AU00-0, 3UF7013-1AU00-0, 3UF7012-1AB00-0, 3UF7013-1AB00-0				
Control circuit						
Rated control supply voltage U_s (acc. to IEC 61131-2)		110 ... 240 V AC/DC; 50/60 Hz	24 V DC			
Operating range						
• SIMOCODE pro C (3UF7000) and SIMOCODE pro V PROFIBUS (3UF7010) SIMOCODE pro V Modbus RTU (3UF7012)		0.85 ... 1.1 × U_s	0.80 ... 1.2 × U_s			
• SIMOCODE pro V PROFINET (3UF7011), SIMOCODE pro V EtherNet/IP (3UF7013) and SIMOCODE pro S (3UF7020)		0.85 ... 1.1 × U_s	0.80 ... 1.2 × U_s			
- Operation		0.85 ... 1.1 × U_s	0.80 ... 1.2 × U_s			
- Start up		0.85 ... 1.1 × U_s	0.85 ... 1.2 × U_s			
Power consumption¹⁾						
• SIMOCODE pro C (3UF7000) and SIMOCODE pro S (3UF7020)		7 VA/5 W	5 W			
• SIMOCODE pro V PROFIBUS (3UF7010) and SIMOCODE pro V Modbus RTU (3UF7012)		10 VA/7 W	7 W			
• SIMOCODE pro V PROFIBUS E15/V4.0 (3UF7010-1A.00-0-Z B01) and SIMOCODE pro V Modbus RTU E03/V2.0 (3UF7012-1A.00-0-Z B01)		7 VA/5 W	4 W			
• SIMOCODE pro V PROFINET (3UF7011) and SIMOCODE pro V EtherNet/IP (3UF7013)		11 VA/8 W	8 W			
Rated insulation voltage U_i	V	300 (for pollution degree 3)				
Rated impulse withstand voltage U_{imp}	kV	4				
Relay outputs						
• Number		3 monostable relay outputs				
- SIMOCODE pro C, SIMOCODE pro V (incl. SIMOCODE pro V PN GP)		2 monostable relay outputs				
- SIMOCODE pro S						
• Specified short-circuit protection for auxiliary contacts (relay outputs)		6 A operational class gG; 10 A quick-response (IEC 60947-5-1)				
- Fuse links		1.6 A, C characteristic (IEC 60947-5-1); 6 A, C characteristic ($I_k < 500$ A)				
- Miniature circuit breaker		6				
• Rated uninterrupted current	A	6				
• Rated switching capacity		6 A/24 V AC; 6 A/120 V AC; 3 A/230 V AC				
- AC-15		2 A/24 V DC; 0.55 A/60 V DC; 0.25 A/125 V DC				
- DC-13						
Inputs (binary)						
4 inputs supplied internally by the device electronics (with 24 V DC) and connected to a common potential						
Thermistor motor protection (binary PTC)						
• Summation cold resistance	kΩ	≤ 1.5				
• Response value	kΩ	3.4 ... 3.8				
• Return value	kΩ	1.5 ... 1.65				
2nd-generation current/voltage measuring modules						
Type		3UF7..0-1AA01-0	3UF7..1-1AA01-0	3UF7..2-1AA01-0	3UF7..3-1.A01-0	3UF7..4-1BA01-0
Main circuit						
Current setting I_e	A	0.3 ... 4	3 ... 40	10 ... 115	20 ... 200	63 ... 630
Rated insulation voltage U_i	V	690				
Rated operational voltage U_e	V	690				
Rated impulse withstand voltage U_{imp}	kV	6				
Rated frequency	Hz	50/60				
Type of current		Three-phase current				
Short circuit		Additional short-circuit protection is required in the main circuit				
Typical voltage measuring range						
• Phase-to-phase voltage/line-to-line voltage (e.g. U_{L1L2})	V	110 ... 690				
• Phase voltage (e.g. U_{L1N})	V	65 ... 400				
Accuracy at 25 °C, 50/60 Hz						
Valid for voltage range						
Valid for current range	A	<ul style="list-style-type: none"> Phase-to-phase voltage U_L in the range 0.85 × 110 V ... 1.1 × 690 V Phase voltage U_L in the range 0.85 × 65 V ... 1.1 × 400 V 				
• Voltage measurement	%	± 1.5				
• Current measurement	%	± 1.5/3 (typical)				
• Temperature drift of current measurement	%	± 0.02 K				
- 3UF7110-1AA01-0	%	± 0.01 K				
- 3UF7111-1AA01-0, 3UF7112-1AA01-0, 3UF7113-1AA01-0, 3UF7113-1BA01-0, 3UF7114-1BA01-0	%	± 0.01 K				
• Power factor measurement (p.f. ≥ 0.5)	%	± 1.5/5 (typical)				
• Apparent power measurement (p.f. ≥ 0.5)	%	± 3/5 (typical)				
• Active power measurement (p.f. ≥ 0.5)	%	± 5/10				
• Energy measurement (p.f. ≥ 0.5)	%	± 5/10				
• Frequency measurement (p.f. ≥ 0.5)	%	± 1.5				
Notes on voltage measurement						
• Supply lines for voltage measurement		In the supply lines from the main circuit for voltage measurement of SIMOCODE pro it may be necessary to provide additional line protection!				

¹⁾ All values are based on a combination consisting of basic unit, current measuring module and operator panel.

Technical data

Current measuring modules						
Type		3UF7100-1AA00-0	3UF7101-1AA00-0	3UF7102-1AA00-0	3UF7103-1.A00-0	3UF7104-1BA00-0
Main circuit						
Current setting I_e	A	0.3 ... 3	2.4 ... 25	10 ... 100	20 ... 200	63 ... 630
Rated insulation voltage U_i	V	690; 3UF7103 and 3UF7104: 1 000 (at pollution degree 3)				
Rated operational voltage U_e	V	690				
Rated impulse withstand voltage U_{imp}	kV	6; 3UF7103 and 3UF7104: 8				
Rated frequency	Hz	50/60				
Type of current		Three-phase current				
Short circuit		Additional short-circuit protection is required in the main circuit				
Accuracy of current measurement (in the range of 1 x minimum current setting I_u to 8 x max. current setting I_o)	%	± 3 (typical)				
Digital modules or multifunction modules						
Type		3UF7300, 3UF7310, 3UF7600				
Control circuit						
Rated insulation voltage U_i	V	300 (at pollution degree 3)				
Rated impulse withstand voltage U_{imp}	kV	4				
Relay outputs		2 monostable or bistable relay outputs (depending on the version)				
• Number		2 monostable or bistable relay outputs (depending on the version)				
• Specified short-circuit protection for auxiliary contacts (relay outputs)		6 A operational class gG; 10 A quick-response (IEC 60947-5-1)				
- Fuse links		1.6 A, C characteristic (IEC 60947-5-1); 6 A, C characteristic ($I_k < 500$ A)				
- Miniature circuit breakers		6				
• Rated uninterrupted current	A	6				
• Rated switching capacity		6 A/24 V AC; 6 A/120 V AC; 3 A/230 V AC				
- AC-15		2 A/24 V DC; 0.55 A/60 V DC; 0.25 A/125 V DC				
- DC-13						
Inputs (binary)		4 inputs, electrically isolated, supplied externally with 24 V DC or 110 ... 240 V AC/DC depending on the version, connected to a common potential				
Ground-fault modules or multifunction modules						
Type		3UF7510, 3UF7600				
Control circuit						
Connectable residual-current transformer		3UL23				
Type of current for monitoring		Type A (AC and pulsating DC residual currents)				
Adjustable response value		30 mA ... 40 A				
Relative measurement error	%	7.5				
Temperature modules or multifunction modules						
Type		3UF7600, 3UF7700				
Sensor circuit						
Number of temperature sensors		3 temperature sensors 1 temperature sensor				
• 3UF7700		3 temperature sensors				
• 3UF7600		1 temperature sensor				
Typical sensor current						
• Pt100	mA	1				
• Pt1000/KTY83/KTY84/NTC	mA	0.2				
Open-circuit/short-circuit detection						
• Sensor type		Pt100/Pt1000	KTY83-110	KTY84	NTC	
- Open circuit		✓	✓	✓	--	
- Short circuit		✓	✓	✓	✓	
- Measuring range	°C	-50 ... +500	-50 ... +175	-40 ... +300	80 ... 160	
Measuring accuracy at 20 °C ambient temperature (T20)	K	< ± 2				
Deviation due to ambient temperature (in % of measuring range)	%	0.05 per K deviation from T20				
Conversion time	ms	500				
Connection type		Two- or three-wire connection				

✓ Detection possible

-- Detection not possible

Technical data

Analog module

Type		3UF74	
Control circuit			
Inputs			
• Channels		2 (passive)	
• Parameterizable measuring ranges	mA	0/4 ... 20	
• Shielding		Up to 30 m shield recommended, from 30 m shield required	
• Max. input current (destruction limit)	mA	40	
• Accuracy	%	± 1	
• Input resistance	Ω	50	
• Conversion time	ms	150	
• Resolution	Bit	12	
• Open-circuit detection		With measuring range 4 ... 20 mA	
Outputs			
• Channels		1	
• Parameterizable output range	mA	0/4 ... 20	
• Shielding		Up to 30 m shield recommended, from 30 m shield required	
• Max. voltage at output	V DC	30	
• Accuracy	%	± 1	
• Max. output load	Ω	500	
• Conversion time	ms	25	
• Resolution	Bit	12	
• Short-circuit proof		Yes	
Connection type		Two-wire connection	
Electrical separation of inputs/output to the device electronics		No	

Fail-safe digital modules

Type		3UF7320-1AB00-0	3UF7320-1AU00-0	3UF7330-1AB00-0	3UF7330-1AU00-0
Control circuit					
Rated control supply voltage U_s	V	24 DC	110 ... 240 AC/DC; 50/60 Hz	24 DC	110 ... 240 AC/DC; 50/60 Hz
Power consumption		3 W	9.5 VA/4.5 W	4 W	11 VA/5.5 W
Rated insulation voltage	V	300			
Rated impulse withstand voltage U_{imp}	kV	4			
Relay outputs					
• Number		2 relay enabling circuits, 2 relay outputs			
Version of the fuse link	A	4, operational class gG			
For short-circuit protection of the relay enabling circuit					
Rated uninterrupted current	A	5			
Rated switching capacity					
• AC-15		3 A/24 V AC; 3 A/120 V AC; 1.5 A/230 V AC			
• DC-13		4 A/24 V DC; 0.55 A/60 V DC; 0.22 A/125 V DC			
Inputs (binary)					
5 (with internal power supply from the device electronics)					
Cable length					
• Between sensor/start signal and evaluation electronics	m	1 500	1 500	--	--
• For further digital signals	m	--	--	300	300
Safety data ¹⁾					
SIL level max. according to IEC 61508		3			
Achievable performance level PL according to EN ISO 13849-1		e			
Achievable category according to EN ISO 13849-1		4			
Stop category according to EN 60204-1		0			
Probability of a dangerous failure for SIL 3 applications					
• Per hour (PFH _d) at a high demand rate according to IEC 62061	1/h	1.0 × 10 ⁻⁸ for 2-channel sensor evaluation		1.0 × 10 ⁻⁸	
• Per hour (PFD _{avg}) at a low demand rate according to IEC 61508		2.0 × 10 ⁻⁶ for 2-channel sensor evaluation		2.0 × 10 ⁻⁶	
T1 value for proof test interval or service duration according to IEC 61508	a	20			

¹⁾ For more safety data, see System Manual "SIMOCODE pro Safety Fail-Safe Digital Modules".

More information**Configuration instructions**

When using an operator panel with display, please note that the type and number of expansion modules that can be connected are limited for the use of a SIMOCODE pro V PROFIBUS basic unit (with product version lower than E15) or SIMOCODE pro V Modbus RTU (with product version lower than E03), [see](#)

- [TIA Selection Tool](#)
- [SIMOCODE pro Manual Collection](#)

Protective separation

All circuits in SIMOCODE pro are safely isolated from each other in accordance with IEC 60947-1. That is, they are designed with double creepages and clearances. In the event of a fault, therefore, no parasitic voltages can be formed in neighboring circuits. The instructions of test log No. 2668 must be complied with.

Types of protection EEx e and EEx d

The overload protection and the thermistor motor protection of the SIMOCODE pro system comply with the requirements for overload protection of explosion-proof motors to the type of protection:

- EEx d "Flameproof enclosure" e.g. according to IEC 60079-1
- EEx e "Increased safety" e.g. according to IEC 60079-7

When using SIMOCODE pro devices with a 24 V DC control voltage, electrical separation must be ensured using a battery or a safety transformer according to IEC 61558-2-6.

EC type test certificate: BVS 06 ATEX F 001

Test report: BVS PP 05.2029 EC.





Type of protection Ex b

The function for dry-running protection of centrifugal pumps in hazardous areas complies with the requirements of the following type of protection:

- Ex b "Control of ignition source", ignition protection system b1, e.g. according to EN 80079-37

SIMOCODE pro is registered for the dry-running protection of centrifugal pumps by means of active power monitoring according to both ATEX and IEC Ex.

Selection and ordering data

Version	SD	Screw terminals	⊕	PU (UNIT, SET, M)	PS*
	d	Article No.	Price per PU		
SIMOCODE pro PROFIBUS					
		SIMOCODE pro C PROFIBUS DP interface, 12 Mbps, RS 485 4 I/3 O freely assignable, input for thermistor connection, monostable relay outputs Rated control supply voltage U_g : • 24 V DC • 110 ... 240 V AC/DC			
3UF7000-1AB00-0		▶ 3UF7000-1AB00-0		1	1 unit
		▶ 3UF7000-1AU00-0		1	1 unit
		SIMOCODE pro S PROFIBUS DP interface, 1.5 Mbps, RS 485 4 I/2 O freely assignable, input for thermistor connection, monostable relay outputs, can be expanded by a multifunction module <u>Note:</u> The connection cable to the current measuring module must be at least 15 cm. Rated control supply voltage U_g : • 24 V DC • 110 ... 240 V AC/DC			
3UF7020-1AU01-0		▶ 3UF7020-1AB01-0		1	1 unit
		▶ 3UF7020-1AU01-0		1	1 unit
		SIMOCODE pro V¹⁾ PROFIBUS DP interface, 12 Mbps, RS 485 4 I/3 O freely assignable, input for thermistor connection, monostable relay outputs, can be expanded by expansion modules Rated control supply voltage U_g : • 24 V DC • 110 ... 240 V AC/DC			
3UF7010-1AB00-0		▶ 3UF7010-1AB00-0		1	1 unit
		▶ 3UF7010-1AU00-0		1	1 unit
SIMOCODE pro PROFINET					
		SIMOCODE pro V PROFINET GP <i>NEW</i> ETHERNET/PROFINET IO, OPC UA server and web server, 100 Mbps, PROFINET system redundancy, 4 I/3 O freely assignable, input for thermistor connection, monostable relay outputs, can be expanded by expansion module, web server in German/English/Chinese/Russian <u>2 x connection to bus through RJ45,</u> Media Redundancy Protocol Rated control supply voltage U_g : • 24 V DC • 110 ... 240 V AC/DC <u>1 x connection to bus through RJ45,</u> Rated control supply voltage U_g : • 24 V DC • 110 ... 240 V AC/DC			
3UF7011-1AB00-1		▶ 3UF7011-1AB00-1		1	1 unit
		▶ 3UF7011-1AU00-1		1	1 unit
		▶ 3UF7011-1AB00-2		1	1 unit
		▶ 3UF7011-1AU00-2		1	1 unit
		SIMOCODE pro V PROFINET ETHERNET/PROFINET IO, OPC UA server and web server, 100 Mbps, 2 x connection to bus through RJ45, PROFINET system redundancy, media redundancy protocol, 4 I/3 O freely assignable, input for thermistor connection, monostable relay outputs, can be expanded by expansion modules, web server in German/English/Chinese/Russian Rated control supply voltage U_g : • 24 V DC • 110 ... 240 V AC/DC			
3UF7011-1AB00-0		▶ 3UF7011-1AB00-0		1	1 unit
		▶ 3UF7011-1AU00-0		1	1 unit

1) For the use of 2nd-generation current/voltage measuring modules, SIMOCODE pro V PROFIBUS with product version E15 (V4.0) must be ordered. This version does not have an NEPSI certificate. It can be ordered at no extra charge. The article number must be supplemented by "-Z" and the order code "B01", e.g. 3UF7010-1AB00-0-Z B01.

Version	SD	Screw terminals 	PU (UNIT, SET, M)	PS*
	d	Article No.	Price per PU	

SIMOCODE pro Modbus RTU



SIMOCODE pro V Modbus RTU¹⁾⁵⁾
 Modbus RTU interface, 57.6 Kbps, RS 485, 4 I/3 O freely assignable, input for thermistor connection, monostable relay outputs, can be expanded by expansion modules
 Rated control supply voltage U_s :
 • 24 V DC
 • 110 ... 240 V AC/DC

3UF7012-1A.00-0

▶	3UF7012-1AB00-0	1	1 unit
▶	3UF7012-1AU00-0	1	1 unit

SIMOCODE pro EtherNet/IP



SIMOCODE pro V EtherNet/IP¹⁾
 EtherNet/IP interface, web server, 100 Mbps, 2 x connection to bus through RJ45, DLR media redundancy, 4 I/3 O freely assignable, input for thermistor connection, monostable relay outputs, can be expanded by expansion modules, web server in German/English/Chinese/Russian
 Rated control supply voltage U_s :
 • 24 V DC
 • 110 ... 240 V AC/DC

3UF7013-1AB00-0

▶	3UF7013-1AB00-0	1	1 unit
▶	3UF7013-1AU00-0	1	1 unit

SIMOCODE pro current or current/voltage measuring modules



Current measuring modules
 • Straight-through transformers
 0.3 ... 3 45 ▶
 2.4 ... 25 45 ▶
 10 ... 100 55 ▶
 20 ... 200 120 ▶
 • Busbar connection⁶⁾
 20 ... 200 120 ▶
 63 ... 630 145 ▶

3UF7103-1AA00-0

▶	3UF7100-1AA00-0	1	1 unit
▶	3UF7101-1AA00-0	1	1 unit
▶	3UF7102-1AA00-0	1	1 unit
▶	3UF7103-1AA00-0	1	1 unit
▶	3UF7103-1BA00-0	1	1 unit
▶	3UF7104-1BA00-0	1	1 unit



2nd-generation current/voltage measuring modules for SIMOCODE pro V¹⁾²⁾
 Voltage measuring up to 690 V, measured values with increased accuracy, power, power factor and frequency monitoring
 • Straight-through transformers
 0.3 ... 4 45 ▶
 3 ... 40 45 ▶
 10 ... 115 55 ▶
 20 ... 200 120 ▶
 • Busbar connection⁶⁾
 20 ... 200 120 ▶
 63 ... 630 145 ▶

3UF7110-1AA01-0

▶	3UF7110-1AA01-0	1	1 unit
▶	3UF7111-1AA01-0	1	1 unit
▶	3UF7112-1AA01-0	1	1 unit
▶	3UF7113-1AA01-0	1	1 unit
▶	3UF7113-1BA01-0	1	1 unit
▶	3UF7114-1BA01-0	1	1 unit



Current/voltage measuring modules for dry-running protection of centrifugal pumps in hazardous areas^{2)3)4) NEW}
 • Straight-through transformers
 0.3 ... 4 45 ▶
 3 ... 40 45 ▶
 10 ... 115 55 ▶
 20 ... 200 120 ▶
 • Busbar connection⁶⁾
 20 ... 200 120 ▶
 63 ... 630 145 ▶

3UF7123-1AA01-0

▶	3UF7120-1AA01-0	1	1 unit
▶	3UF7121-1AA01-0	1	1 unit
▶	3UF7122-1AA01-0	1	1 unit
▶	3UF7123-1AA01-0	1	1 unit
▶	3UF7123-1BA01-0	1	1 unit
▶	3UF7124-1BA01-0	1	1 unit

1) The SIMOCODE ES (TIA Portal) V14 software or higher is necessary for parameterization, see page 3/83.
 2) When installing the basic unit on a current/voltage measuring module, the connection cable must be at least 15 cm long.
 3) The current/voltage measuring modules for dry-running protection require SIMOCODE pro V PROFIBUS basic units as of product version E16 (expected to be available from 03/2019), SIMOCODE pro V PROFINET as of product version E13 (expected to be available from 10/2018) or SIMOCODE pro V EtherNet/IP as of product version E04 (expected to be available from 03/2019).
 4) When using an operator panel with display with the current/voltage measuring modules for dry-running protection, an operator panel with display as of product version E03 (both versions 3UF7210-1AA01-0 and 3UF7210-1BA01-0 expected to be available from 03/2019) is required.

5) For the use of 2nd-generation current/voltage measuring modules, SIMOCODE pro V Modbus RTU with product version E03 (V2.0) must be ordered. This version does not have an NEPSI certificate. It can be ordered at no extra charge. The article number must be supplemented by "-Z" and the order code "B01", e.g. **3UF7012-1AB00-0-Z B01**.
 6) One terminal parts kit 3RT1955-4PA00 or 3RT1966-4PA00 (see page 3/82) is included in the scope of delivery for connection to a contactor.

Note:

SIMOCODE pro V basic unit in a hardened version via SIPLUS extreme upon request.

Version	Current setting	Width	SD	Screw terminals	⊕	PU (UNIT, SET, M)	PS*
	A	mm	d	Article No.	Price per PU		

SIMOCODE pro operator panels



3UF7200-1AA01-0

Operator panels

Installation in control cabinet door or front plate, for plugging into all SIMOCODE pro basic units, ten LEDs for status indication and user-assignable buttons for controlling the motor, titanium gray

▶	3UF7200-1AA01-0	1	1 unit
---	------------------------	---	--------



3UF7210-1.A01-0

Operator panels with display for SIMOCODE pro V

Installation in control cabinet door or front plate, for plugging into SIMOCODE pro V, seven LEDs for status indication and user-assignable buttons for controlling the motor, multilingual display, e.g. for indication of measured values, status information or fault messages, titanium gray

- ▶ English/German/French/Spanish/Portuguese/Italian/Polish/Finnish
- ▶ English/Chinese/Russian/Korean

▶	3UF7210-1AA01-0	1	1 unit
---	------------------------	---	--------

▶	3UF7210-1BA01-0	1	1 unit
---	------------------------	---	--------

Selection and ordering data

Version	SD	Screw terminals		PU (UNIT, SET, M)	PS*
	d	Article No.	Price per PU		

Expansion modules for SIMOCODE pro V

With SIMOCODE pro V, it is possible to expand the type and number of inputs and outputs in steps. Each expansion module has two system interfaces on the front. Through the one system interface the expansion module is connected to the system interface of the SIMOCODE pro V using a connection cable; through the second system interface, further expansion modules or the operator panel can be connected. The power supply for the expansion modules is provided by the connection cable through the basic unit.

Notes:

The SIMOCODE pro V PN GP basic unit can be used with the 3UF7300-1A.00-0 monostable digital module, the 3UF7510-1AA00-0 ground-fault module, or the 3UF7700-1AA0-0 temperature module.

Please order connection cable separately, [see page 10/22](#).

Digital modules

Up to two digital modules can be used to add additional binary inputs and relay outputs to the basic unit. The input circuits of the digital modules are supplied from an external power supply.

Four binary inputs and two relay outputs, up to two digital modules can be connected

Relay outputs	Input voltage	
Monostable	24 V DC	▶ 3UF7300-1AB00-0
	110 ... 240 V AC/DC	▶ 3UF7300-1AU00-0
Bistable	24 V DC	▶ 3UF7310-1AB00-0
	110 ... 240 V AC/DC	▶ 3UF7310-1AU00-0

Analog modules

By means of the analog module, the basic unit can be optionally expanded by analog inputs and outputs (0/4 ... 20 mA).

Two inputs (passive) for input and one output for output of 0/4 ... 20 mA signals, max. one analog module can be connected per pro V PB/MB RTU basic unit and max. two analog modules per pro V PN/EIP basic unit

Ground-fault modules

Ground-fault monitoring using 3UL23 residual-current transformers and ground-fault modules is used in cases where precise detection of the ground-fault current is required or power systems with high impedance are grounded.

With the ground-fault module, it is possible to determine the precise fault current as a measured value, and to define freely selectable warning and trip limits in a wide range from 30 mA ... 40 A.

One input for connecting a 3UL23 residual-current transformer, up to one ground-fault module can be connected

Note:

For corresponding residual-current transformers, [see page 11/55](#).

Temperature modules

Irrespective of the thermistor motor protection of the basic units, up to an additional three analog temperature sensors can be evaluated using a temperature module.

Sensor types: Pt100/Pt1000, KTY83/KTY84 or NTC

Three inputs for connecting up to three analog temperature sensors, up to one temperature module can be connected per pro V PB/MB RTU basic unit and up to two temperature modules per pro V PN/EIP basic unit



3UF7300-1AB00-0



3UF7400-1AA00-0



3UF7510-1AA00-0



3UF7700-1AA00-0

Selection and ordering data

Version	SD	Screw terminals	⊕	PU (UNIT, SET, M)	PS*
	d	Article No.	Price per PU		

Fail-safe expansion modules for SIMOCODE pro V

Thanks to the fail-safe expansion modules, SIMOCODE pro V can be expanded with the function of a safety relay for the fail-safe disconnection of motors. A maximum of one fail-safe digital module can be connected; it can be used instead of a digital module.

The fail-safe expansion modules are equipped likewise with two system interfaces at the front for making the connection to other system components. Unlike other expansion modules, power is supplied to the modules through a separate terminal connection.

Note:

Please order connection cable separately, see page 3/80.

DM-F Local fail-safe digital modules

For fail-safe disconnection using a hardware signal

Two relay enabling circuits, joint switching; two relay outputs, common potential disconnected fail-safe; inputs for sensor circuit, start signal, cascading and feedback circuit, safety function adjustable using DIP switches

Rated control supply voltage U_s :

- 24 V DC
- 110 ... 240 V AC/DC

▶	3UF7320-1AB00-0	1	1 unit
▶	3UF7320-1AU00-0	1	1 unit



3UF7320-1AB00-0

DM-F PROFIsafe fail-safe digital modules¹⁾

For fail-safe disconnection using PROFIBUS/PROFIsafe or PROFINET/PROFIsafe

Two relay enabling circuits, joint switching; two relay outputs, common potential disconnected fail-safe; one input for feedback circuit; three binary standard inputs

Rated control supply voltage U_s :

- 24 V DC
- 110 ... 240 V AC/DC





▶	3UF7330-1AB00-0	1	1 unit
▶	3UF7330-1AU00-0	1	1 unit



3UF7330-1AB00-0

¹⁾ Cannot be used in conjunction with SIMOCODE pro V for Modbus RTU or EtherNet/IP communication.

Selection and ordering data

Version	SD	Article No.	Price per PU	PU (UNIT, SET, M)	PS*																																																
Connection cables (essential accessory)																																																					
 <p>In different lengths for connecting basic unit, current measuring module, current/voltage measuring module, operator panel or expansion modules</p>																																																					
<table border="1"> <thead> <tr> <th>Version</th> <th>Length</th> <th></th> <th></th> <th></th> <th></th> </tr> </thead> <tbody> <tr> <td rowspan="5">Flat</td> <td>0.025 m</td> <td></td> <td></td> <td></td> <td></td> </tr> <tr> <td>0.1 m</td> <td></td> <td></td> <td></td> <td></td> </tr> <tr> <td>0.15 m</td> <td>NEW</td> <td></td> <td></td> <td></td> </tr> <tr> <td>0.3 m</td> <td></td> <td></td> <td></td> <td></td> </tr> <tr> <td>0.5 m</td> <td></td> <td></td> <td></td> <td></td> </tr> <tr> <td rowspan="3">Round</td> <td>0.5 m</td> <td></td> <td></td> <td></td> <td></td> </tr> <tr> <td>1.0 m</td> <td></td> <td></td> <td></td> <td></td> </tr> <tr> <td>2.5 m</td> <td></td> <td></td> <td></td> <td></td> </tr> </tbody> </table>						Version	Length					Flat	0.025 m					0.1 m					0.15 m	NEW				0.3 m					0.5 m					Round	0.5 m					1.0 m					2.5 m				
Version	Length																																																				
Flat	0.025 m																																																				
	0.1 m																																																				
	0.15 m	NEW																																																			
	0.3 m																																																				
	0.5 m																																																				
Round	0.5 m																																																				
	1.0 m																																																				
	2.5 m																																																				
3UF7932-0AA00-0		3UF7930-0AA00-0		1	1 unit																																																
		3UF7931-0AA00-0		1	1 unit																																																
		3UF7934-0AA00-0		1	1 unit																																																
		3UF7935-0AA00-0		1	1 unit																																																
		3UF7932-0AA00-0		1	1 unit																																																
		3UF7932-0BA00-0		1	1 unit																																																
		3UF7937-0BA00-0		1	1 unit																																																
		3UF7933-0BA00-0		1	1 unit																																																
PC cables and adapters																																																					
 <p>USB PC cables</p> <p>For connecting to the USB interface of a PC/PG, for communication with SIMOCODE pro through the system interface</p>																																																					
3UF7941-0AA00-0		3UF7941-0AA00-0		1	1 unit																																																
<p>USB/serial adapters</p> <p>For connecting an RS 232 PC cable to the USB interface of a PC</p>																																																					
	5	3UF7946-0AA00-0		1	1 unit																																																
Memory modules																																																					
 <p>Enable transmission to a new system, e.g. when a device is replaced, without the need for additional aids or detailed knowledge of the device.</p>																																																					
Memory modules for SIMOCODE pro C																																																					
3UF7901-0AA01-0		3UF7900-0AA01-0		1	1 unit																																																
For saving the complete parameterization of a SIMOCODE pro C system, titanium gray																																																					
Memory modules for SIMOCODE pro S and pro V																																																					
		3UF7901-0AA01-0		1	1 unit																																																
For saving the complete parameterization of a SIMOCODE pro system, titanium gray																																																					
Interface covers																																																					
 <p>For system interface, titanium gray</p>																																																					
3RA6936-0B	10	3RA6936-0B		1	5 units																																																
Addressing plugs																																																					
 <p>For assigning the PROFIBUS or Modbus RTU address without using a PC/PG to SIMOCODE pro through the system interface</p>																																																					
3UF7910-0AA00-0		3UF7910-0AA00-0		1	1 unit																																																

Version	SD	Article No.	Price per PU	PU (UNIT, SET, M)	PS*
---------	----	-------------	--------------	-------------------	-----

Accessories for motor control centers

 <p>3UF7902-0AA00-0</p>	<p>With the draw-out technology often used in motor control centers it is possible to integrate a SIMOCODE pro initialization module in the switchboard on a permanent basis. Feeder-related parameter and address data can then be permanently assigned to this feeder.</p>																							
	<p>Initialization modules</p> <p>▶ For automatic parameterization of SIMOCODE pro S and SIMOCODE pro V basic units (pro V PROFIBUS basic units from product version E09)</p>	<p>3UF7902-0AA00-0</p>	1	1 unit																				
	<p>Y connection cables</p> <p>For use in conjunction with the initialization module; connects the basic unit, current measuring module or current/voltage measuring module, and initialization module</p>																							
	<table border="1"> <thead> <tr> <th>System interface length</th> <th>Open cable end</th> <th></th> <th></th> <th></th> </tr> </thead> <tbody> <tr> <td>0.1 m</td> <td>1.0 m</td> <td>▶</td> <td>3UF7931-0CA00-0</td> <td>1 1 unit</td> </tr> <tr> <td>0.5 m</td> <td>1.0 m</td> <td>▶</td> <td>3UF7932-0CA00-0</td> <td>1 1 unit</td> </tr> <tr> <td>1.0 m</td> <td>1.0 m</td> <td>▶</td> <td>3UF7937-0CA00-0</td> <td>1 1 unit</td> </tr> </tbody> </table>	System interface length	Open cable end				0.1 m	1.0 m	▶	3UF7931-0CA00-0	1 1 unit	0.5 m	1.0 m	▶	3UF7932-0CA00-0	1 1 unit	1.0 m	1.0 m	▶	3UF7937-0CA00-0	1 1 unit			
System interface length	Open cable end																							
0.1 m	1.0 m	▶	3UF7931-0CA00-0	1 1 unit																				
0.5 m	1.0 m	▶	3UF7932-0CA00-0	1 1 unit																				
1.0 m	1.0 m	▶	3UF7937-0CA00-0	1 1 unit																				

Bus connection terminals

 <p>3UF7960-0AA00-0</p>	<p>For shield support and strain relief of the PROFIBUS cable on a SIMOCODE pro S</p>	▶	3UF7960-0AA00-0	1	1 unit
---	---	---	------------------------	---	--------

Door adapters

 <p>3UF7920-0AA00-0</p>	<p>For external connection of the system interface, e.g. outside a control cabinet</p>	▶	3UF7920-0AA00-0	1	1 unit
--	--	---	------------------------	---	--------

Adapters for operator panel

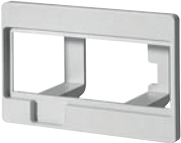



 <p>3UF7922-0AA00-0</p>	<p>The adapter enables the smaller 3UF7200 operator panel from SIMOCODE pro to be used in a front panel cutout in which previously, e.g. after a change of system, a larger 3UF52 operator panel from SIMOCODE-DP had been used, degree of protection IP54</p>	▶	3UF7922-0AA00-0	1	1 unit
--	--	---	------------------------	---	--------

Labeling strips

 <p>3UF7925-0AA02-0</p>	<p>• For pushbuttons of the 3UF720 operator panel</p>	▶	3UF7925-0AA00-0	100	400 units
	<p>• For pushbuttons of the 3UF721 operator panel with display</p>	▶	3UF7925-0AA01-0	100	600 units
	<p>• For LEDs of the 3UF720 operator panel</p>	▶	3UF7925-0AA02-0	100	1 200 units

Push-in lugs

 <p>3RV2928-0B</p>	<p>For screw fixing, e.g. on mounting plate, 2 units required per device</p>				
	<p>• Can be used for 3UF71.0, 3UF71.1 and 3UF71.2</p>	2	3RV2928-0B	100	10 units
	<p>• Can be used for 3UF700, 3UF701, 3UF73, 3UF74, 3UF75 and 3UF77</p>	5	3RP1903	1	10 units
	<p>• Can be used for 3UF7020, 3UF7600</p>	2	3ZY1311-0AA00	1	10 units

Version	SD	Article No.	Price per PU	PU (UNIT, SET, M)	PS*
Terminal covers					
Covers for cable lugs and busbar connections					
 <p>3RT1956-4EA1</p>	<ul style="list-style-type: none"> Length 100 mm, can be used for 3UF71.3-1BA0.-0 	▶ 3RT1956-4EA1		1	1 unit
	<ul style="list-style-type: none"> Length 120 mm, can be used for 3UF71.4-1BA0.-0 	▶ 3RT1956-4EA2		1	1 unit
Covers for box terminals					
 <p>3RT1956-4EA2</p>	<ul style="list-style-type: none"> Length 25 mm, can be used for 3UF71.3-1BA0.-0 	▶ 3RT1956-4EA2		1	1 unit
	<ul style="list-style-type: none"> Length 30 mm, can be used for 3UF71.4-1BA0.-0 	▶ 3RT1956-4EA3		1	1 unit
Covers for screw terminals					
Between contactor and current measuring module or current/voltage measuring module for direct mounting					
<ul style="list-style-type: none"> Can be used for 3UF71.3-1BA0.-0 					
<ul style="list-style-type: none"> Can be used for 3UF71.4-1BA0.-0 					
Terminal parts kit					
Can be used for current and/or current/voltage measuring modules with standard mounting rail connection, complete for one contactor					
<ul style="list-style-type: none"> M 8 x 25 					
<ul style="list-style-type: none"> M 10 x 30 					
Box terminal blocks					
 <p>3RT1955-4G</p>	For round and ribbon cables				
	<ul style="list-style-type: none"> Up to 70 mm², can be used for 3UF71.3-1BA0.-0 	▶ 3RT1955-4G		1	1 unit
	<ul style="list-style-type: none"> Up to 120 mm², can be used for 3UF71.3-1BA0.-0 	▶ 3RT1956-4G		1	1 unit
<ul style="list-style-type: none"> Up to 240 mm², can be used for 3UF71.4-1BA0.-0 					
Bus termination modules					
 <p>3UF1900-1KA00</p>	With separate control supply voltage for bus termination following the last unit on the bus line				
	Supply voltage:				
<ul style="list-style-type: none"> 115/230 V AC 					
<ul style="list-style-type: none"> 24 V DC 					

Overview

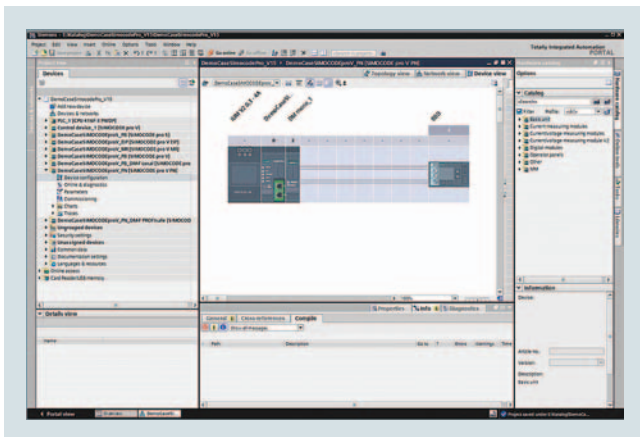

Selection of SIMOCODE pro device configuration in SIMOCODE ES (TIA Portal)

More information

- Industry Mall, see www.siemens.com/product?3ZS1
- TIA Selection Tool Cloud (TST Cloud)
- Software download
 - For SIMOCODE pro S, see <https://support.industry.siemens.com/cs/ww/en/view/109752321>
 - For SIMOCODE pro V, see <https://support.industry.siemens.com/cs/ww/en/view/109480470>

SIMOCODE ES is the central software for configuration, startup, operation and diagnostics of SIMOCODE pro.

SIMOCODE ES Version 15 is available as a powerful successor to Version 2007, which is based on the central engineering framework Totally Integrated Automation Portal (TIA Portal).

SIMOCODE ES V15 is integrated seamlessly when further TIA Portal-based software such as STEP 7 or WinCC is available, thus enabling users to achieve a consistent, efficient and intuitive solution for all automation tasks.

However, use of SIMOCODE ES V15 as stand-alone software also provides these advantages.

Three program versions

The user can choose between three different versions of SIMOCODE ES:

- SIMOCODE ES Basic
- SIMOCODE ES Standard
- SIMOCODE ES Premium

New: From V15, the powerful SIMOCODE ES Basic tool for startup or maintenance personnel is available for downloading free of charge in the Siemens Industry Online Support (see "More information").

SIMOCODE ES Standard and Premium are the perfect tools for engineers or configuration engineers on account of their larger scope of functions and integrated graphics editor. Unlike the Standard version, SIMOCODE ES Premium also permits parameterization and diagnostics via PROFIBUS/PROFINET/Ethernet. Indication of all operating, service and diagnostics data supplies important information about the current state of the motor and plant at all times – everywhere on PROFIBUS/PROFINET/Ethernet.

SIMOCODE ES V15	Basic	Standard	Premium
Access via the local interface on the device	✓	✓	✓
Parameter assignment in list form	✓	✓	✓
Parameter printing in list form	✓	✓	✓
Operating	✓	✓	✓
Diagnostics	✓	✓	✓
Test	✓	✓	✓
Service data	✓	✓	✓
Analog value recording ¹⁾	✓	✓	✓
Trend display of measured values	--	✓	✓
Parameterizing with convenient graphical display	--	✓	✓
Parameterizing with the integrated graphics editor (CFC-based)	--	✓	✓
Printing of diagrams	--	✓	✓
Parameter comparison	--	✓	✓
Access via PROFIBUS/PROFINET/Ethernet ²⁾	--	--	✓
Teleservice via MPI	--	--	✓
Routing ³⁾	--	--	✓

✓ Function available

-- Function not available

1) For SIMOCODE pro V.

2) In combination with Modbus devices, SIMOCODE ES Premium does not offer any additional functions compared with SIMOCODE ES Standard.

3) See <http://support.automation.siemens.com/WWW/view/en/109738745>.

Working with libraries

Users can create copy templates for SIMOCODE pro device configuration and can manage them in global or project libraries.

This way, individual modules, diagrams and complete device configurations can be saved as reusable elements for frequently occurring tasks.

Integrated graphics editor

The graphics editor is a part of SIMOCODE ES Standard and SIMOCODE ES Premium. It is based on the Continuous Function Chart (CFC) and adds a powerful tool to the parameterizing interface that enables easy parameterization of devices by drag & drop. What is more, all the parameters can also be edited directly in the graphics editor. Extremely compact documentation of all configured parameters is possible, as is the graphic online presentation of the configured device functions including all signal states during operation.

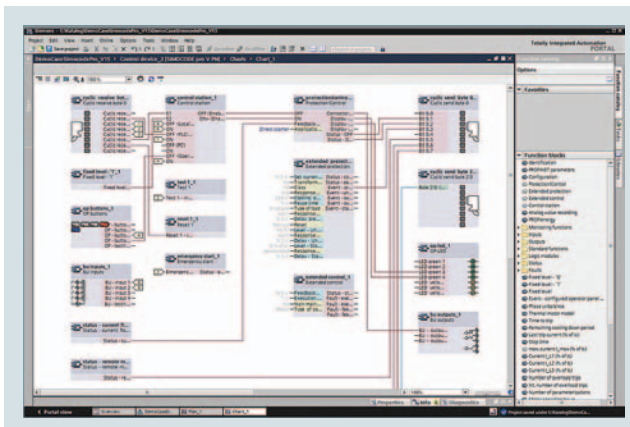

Parameterize easily and ergonomically with the CFC-based graphics editor of SIMOCODE ES V15

Online functions for startup and diagnostics

To this end, SIMOCODE ES provides powerful functions for startup and diagnostics of motor feeders. Besides a detailed display of status information and the causes of faults, all available measurement and statistics data can be retrieved online. Access to the fault and event memory and also to analog values recorded on the device, e.g. current or voltage, is also possible.

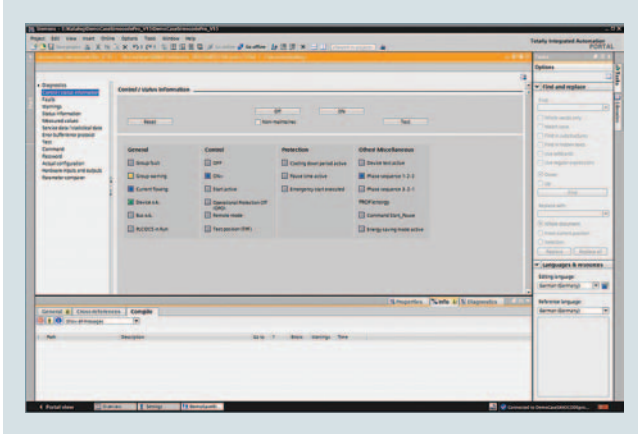

Commissioning functions of SIMOCODE ES V15

Trend display of measured values

With this online function, SIMOCODE ES Standard or Premium can present the trends of different measured values. It is thus possible for example to record and evaluate the start-up characteristic of a motor or its behavior under different load conditions.

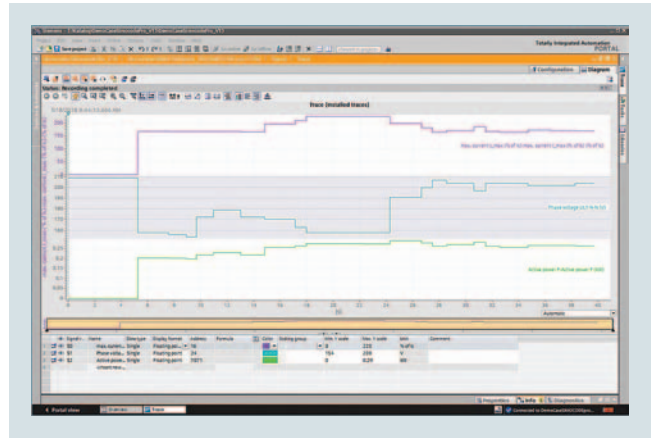

Live trend display of SIMOCODE ES V15

Additional functions

SIMOCODE ES V15 offers numerous advantages of the TIA Portal that can be used in an integrated working environment.

Seamless integration

When using other TIA Portal-based software such as STEP 7 or WinCC, for example, the configuration for devices and networks for all components used is created in a standardized environment.

Teleservice via MPI

The SIMOCODE ES (TIA Portal) Premium version supports the use of MPI Teleservice (comprising the Teleservice software and various Teleservice adapters) for remote diagnostics of the devices. This facilitates diagnostics and maintenance, and it shortens response times for service purposes.

Benefits

- Easy parameterization with the graphics editor based on the Continuous Function Chart (CFC) reduces engineering work and shortens startup times
- Clear plant documentation by means of graphic presentation
- Detailed information, also when there are faults, is a help for maintenance personnel and shortens downtimes
- Universally applicable through stand-alone version or seamless integration into the central engineering framework when other TIA Portal-based software such as STEP 7 or WinCC are available
- Parameter changes are also possible during normal operation
- Users can create copy templates for device configurations and can manage them in global libraries

Selection and ordering data

Parameterization and service software for SIMOCODE pro 3UF7

- Delivered without PC cable

Version	SD	Article No.	Price per PU	PU (UNIT, SET, M)	PS*
	d				

SIMOCODE ES V15 Basic

<p>Basic functional scope including Premium Trial License</p> <p>Engineering software, software download, Class A, 6 languages (German/English/French/Italian/Spanish/Chinese), for all SIMOCODE pro, online functions via system interface</p>		3ZS1322-6CE13-0YG8		1	1 unit
--	--	---------------------------	--	---	--------

SIMOCODE ES V15 Standard



3ZS1322-5CC13-0YA5

<p>Floating license for one user</p> <p>Engineering software, software and documentation on DVD, 6 languages (German/English/French/Italian/Spanish/Chinese), Combo license for parallel use of versions 2007 and V15 of SIRIUS ES, for all SIMOCODE pro, online functions via system interface, parameterizing with the integrated graphics editor (CFC-based)</p> <ul style="list-style-type: none"> License key on USB flash drive, Class A License key and software download, Class A 					
<p>Upgrade for SIMOCODE ES 2007 Standard</p> <p>Floating license for one user, engineering software, software and documentation on DVD, license key on USB flash drive, Class A, 6 languages (German/English/French/Italian/Spanish/Chinese), Combo license for parallel use of versions 2007 and V15 of SIRIUS ES, for all SIMOCODE pro, online functions via system interface, parameterizing with integrated graphics editor (CFC-based)</p>				2	
<p>Software Update Service</p> <p>For 1 year with automatic extension, requires software version of SIMOCODE ES (TIA Portal), engineering software, software and documentation on DVD, online functions via system interface, parameterizing with integrated graphics editor (CFC-based)</p>					

Notes:

SIMOCODE ES V12/V13/V14 licenses can also be used for SIMOCODE ES V15.

Please order PC cable separately, [see page 3/80](#).

For a description of the software versions, [see page 3/83](#).

